

Service catalogue

Specification & Design Guide

RAWLPLUG®

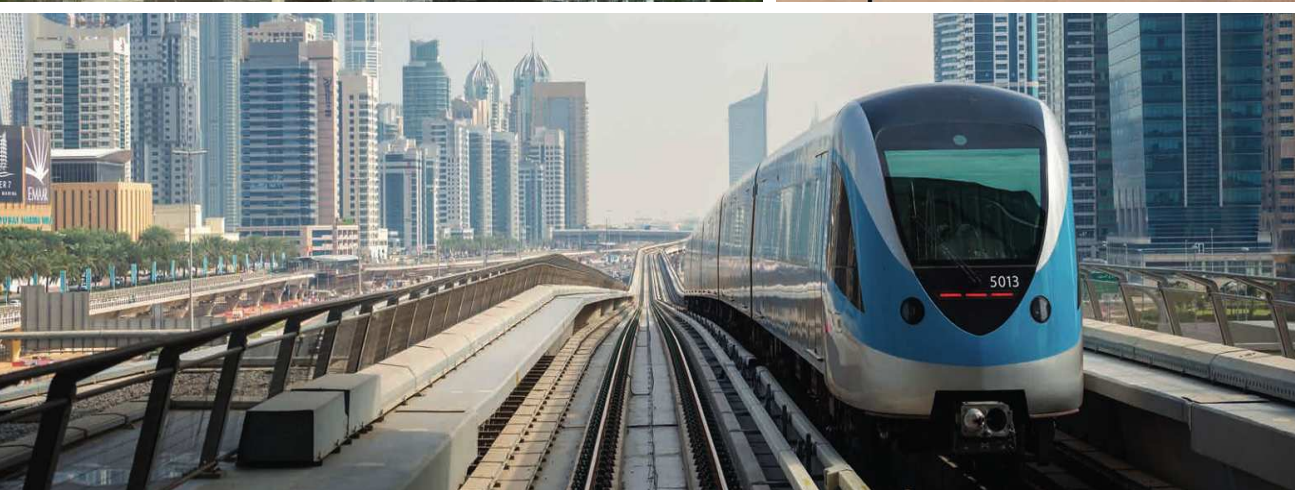
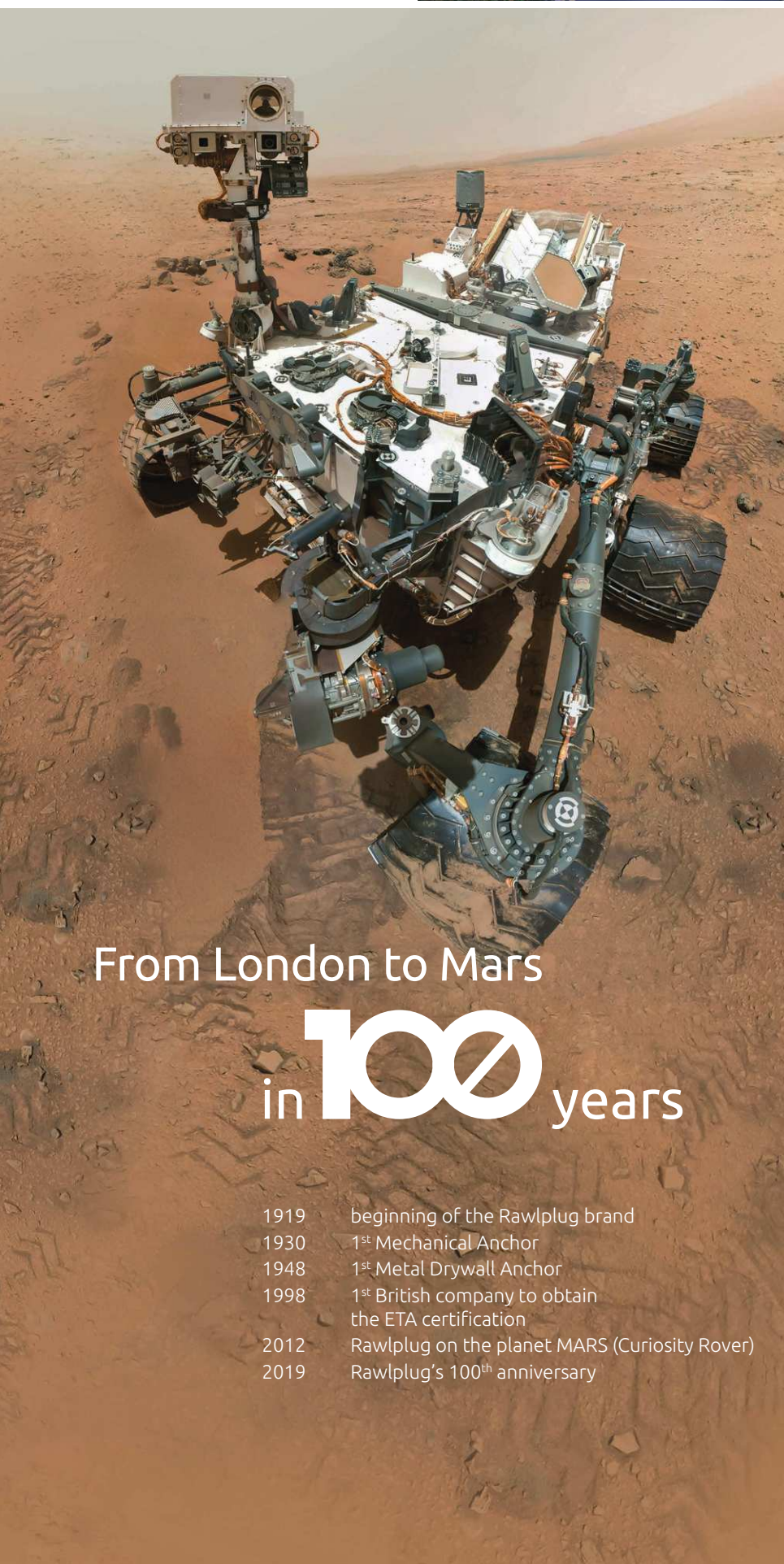

From London to Mars
in **100** years

- 1919 beginning of the Rawlplug brand
- 1930 1st Mechanical Anchor
- 1948 1st Metal Drywall Anchor
- 1998 1st British company to obtain the ETA certification
- 2012 Rawlplug on the planet MARS (Curiosity Rover)
- 2019 Rawlplug's 100th anniversary

100 years 1919-2019 **RAWLPLUG**®

Everywhere in the world

Rawlplug is the global brand of first choice. In the everyday pursuit of Rawlplug's vision, we keep the promise expressed in our mission, as we support our customers with state-of-the-art products they can trust without reservations. Having chosen them, you receive a guarantee that buildings and facilities visited daily by thousands of people not only look great, but are absolutely safe to use. We can proudly claim that, over the last 100 years, Rawlplug has become an unsung hero of numerous investment projects completed all over the world.

100 YEARS OF EXPERTISE IN FIXINGS, FASTENERS AND TOOLS

Content

Rawlplug Offer 8
Product. Services. Training

Basics of anchoring 26
Types of anchors, anchor selection factors, types of anchors. Design of fastening for use in concrete. Design of fastenings in concrete in accordance with EN 1992-4:2018, static and quasi-static loads.

Bonded Anchors 74
Uncompromising technical parameters and safety guaranteed in all applications.

Mechanical Anchors 218
Advanced technology for high load capacity and simplicity of use.

Lightweight Fixings 282
Strength, versatility and simplicity of installation in all substrates and with any fixture.

Basics to façade & roofing fixings 300
Design fixings taking into account wind load, for concrete, masonry, steel and timber substrates.

Facade Fixings 318
Simplicity and speed of installation in innovative solutions for energy-saving buildings.

Roofing Fixings 344
System solutions ensuring efficient installation and long service life.

Content

BONDED ANCHORS		
THREADED RODS	R-KEX-II with Threaded Rods	82
	R-KEX-I with Threaded Rods	89
	R-KER-II R-CFS+KER-II with Threaded Rods	95
	R-CAS-V Spin-In Capsule with Threaded Rods	102
	R-HAC-V Hammer-In Capsule with Threaded Rods	106
SOCKETS	R-KEX-II with Sockets	116
	R-KER-II R-CFS+KER-II Hybrid resin with Sockets	120
REBAR	R-KEX-II with Rebar as an Anchor	126
	R-KEX-I with with Rebar as an Anchor	132
	R-KER-II R-CFS+KER-II with Rebar as an Anchor	137
POST-INSTALLED REBAR	R-HAC-V Hammer-In Capsule with Rebar	143
	R-KEX-II with Post-installed rebar	147
	R-KEX-I with Post-installed rebar	156
MASONRY	R-KER-II-S R-CFS+KER-II-S with Post-installed rebar	164
	R-KEM-II RM50 with Threaded Rods for Masonry	171
Accessories		176



MECHANICAL ANCHORS		
STRUCTURAL	R-LX Countersunk screw anchors - structural fixings	222
	R-HPTIIA4 Stainless Steel Throughbolt	230
	R-HPTII-ZF Zinc Flake Throughbolt	235
	R-XPTII-A4 Stainless Steel Throughbolt	239
	R-XPTIII-HD Hot Dip Galvanized Throughbolt	242
	R-XPT Throughbolt	244
	R-RB Rawlbolt® for use in cracked and non-cracked concrete	247
	R-SPL Safety Plus	252
	R-DCA-A4 Stainless Steel Wedge Anchor	256
	R-DCA Wedge Anchor	258
NON STRUCTURAL	R-DCL Lipped Wedge Anchors	260
	R-LX Concrete screw anchors - multipoint structural fixings	263
	R-RB Rawlbolt® for use in hollow core slab and ceramic substrates	272

Content



LIGHTWEIGHT FIXINGS		
FRAME FIXINGS	R-FF1 Nylon frame fixing countersunk	283
	R-FFS Frame fixing with the shortest anchoring zone	286
UNIVERSAL FIXINGS	UNO® Universal plug with screw	288
	4ALL Universal nylon plug with screw	290
METAL FIXINGS	GS Ceiling wedge anchor	293
HAMMER FIXINGS	R-FX-N Nylon hammer-in fixing	295

FACADE FIXINGS		
SCREW-IN FIXINGS	R-TFIX-8S Universal facade fixings	320
	R-TFIX-8S-X Universal facade fixings	323
HAMMER-IN FIXINGS	R-TFIX-8M Facade fixings with metal nail	326
	TFIX-8P Facade fixings with plastic pin	329
STEEL FIXINGS	MBA/MBA-SS Facade fixings	331
WASHERS	KCX Tube insulation washer	333
	R-KC Insulation washer	336
	R-DB Ceiling screw-in solution with washer	338
	R-KWL Insulation retaining plate	340
	R-KWX Insulation retaining plate with perforator	341



Content



ROOFING INSULATION FIXINGS		
SLEEVE	R-GOK Telescopic sleeve with round plate	345
SCREWS	R-WBT Screw for concrete	348
	R-WX-T Self-drilling screws for steel	350
	R-WO-T Screws for steel	352
	R-WW-T Screws for timber	354
WASHERS	R-POK Steel washers	356
	R-POK Steel washers	357





Rawlplug® Offer

Rawlplug® has been operating as an expert in fixings, fasteners and tools for 100 years.

Although the most important, our products designed for professionals are not the only pillar of our comprehensive offering. They are complemented by specialised services and an innovative training programme. They have all been created to provide our customers, namely engineers, architects, constructors, contractors or salespeople, with access to a full portfolio of capabilities, know-how and best practices aimed to support them in the everyday pursuit of various tasks and business goals. And we can actually vouch for that, because we know our customers and respect their work. We are in touch with them on a daily basis, watching and listening to them carefully. We wish to share with them our knowledge and experience, allowing them to meet even the most ambitious challenges.



Products

The Rawlplug® offering spans as many as **10 specialised categories of products** manufactured in some of the most advanced production plants in Europe. Rawlplug is the only brand that can actually cater for the needs of all segments of the construction industry. Every product is provided between several to several dozen variants matching specific requirements of different substrates, applications and installation conditions. Each one comes with dedicated accessories, altogether forming a complete system.

Services

Our extensive portfolio of services dedicated for engineers, designers and constructors stems from our comprehensive approach to the designing of fixings. What is interesting about our range of tools tailored to the needs of all these professionals as well as the extensive technical assistance is that, on the one hand, they provide the consumers of the Rawlplug® services with high comfort of working under conditions which affect their efficiency and enable them to save time, and on the other hand, ensure safety which they find so important at work.



RAWLPLUG® Academy



Training

The brand's training offer is delivered under the **Rawlplug Academy®** project, being a truly innovative development programme based on the foundation of comprehensive development of knowledge and skills of our customers. The integration of Rawlplug Academy's four pillars, i.e. the e-learning platform, the Training Centre in London, the mobile education and development centre known as the RawlTruck, as well as traditional workshops and the knowledge base, makes it the most comprehensive and useful educational scheme in the sector of fixings and fasteners.



Timeless inventions

The world's first wall plug was a prelude to Rawlplug's further patents which revolutionised the construction industry:

1919 Rawlplug
The world's first wall plug

1926 Rawlhammer
The world's first patented hammer drill

1934 Rawlbolt
The world's first mechanical anchor

1941 Rawlnut
The world's first shock- and corrosion-resistant fixing
Spring Toggle
The world's first fixing solution dedicated to drywall applications

1948 Rawlanchor
Drywall fixing solution which revolutionised the market

100 years
1919-2019
RAWLPLUG®

Heritage

John Joseph Rawlings
– entrepreneur, visionary, inventor.

The world's first wall plug he had patented, triggered a true revolution in the construction industry and went down in history for good. At the same time, this invention marked the beginning of a completely new history – a history of the brand whose contemporary strength draws abundantly from the legacy of the past, the achievements of the present and the vision of the future.

– A brand which not only astonished the general public over decades with innovative solutions and products dedicated to professionals, but also with its panache and scale of operations, extraordinary ideas that revolutionised the marketing of its era, and its comprehensive approach to customers' needs and expectations, in which it has never ceased to be a role model. We are deeply convinced that the true Renaissance man of the construction sector, whom John Joseph Rawlings definitely was, would be proud of us. He would surely commend us on building the brand's strength on the grounds which combine the past heritage, the achievements of the present and the vision of the future.



Revolution in marketing

It's truly extraordinary that whatever the effort undertaken by the Rawlplug brand, it stepped far beyond the standards of their day and age. Take the publicity campaign following their breakthrough invention of the world's first wall plug. It was then that the brand spent thousands of pounds for press advertising, only to change the potential users' mindset vis-à-vis the actual fixing capabilities of their times. Acting with impressive panache and on a massive scale, the brand made a commercial sensation, all the more since never before had any construction company been advertised on Daily Mail's front page!



Travelling Rawlplug

What proved unquestionably supportive of the brand's global expansion was the mobile display installation known as Rawlplug Travelling Showroom. It marked yet another revolution in marketing. These vehicles took long trips lasting several months on all continents, from Sweden to Australia, and made a sensation in each market where they appeared. Never before had the potential customers encountered such a direct form of commodity promotion combined with the opportunity to use the products in practice. In a tailored van, customers could become familiar with the full portfolio of fixings as well as product datasheets, use individual items on site, thus learning about their applications and installation methods, as well as speak to the brand's experts, hoping for some individual consultations.



Service that begins on drawing boards

Rawlplug has always understood and recognised the role and importance of architects, designers and engineers. Already in the 1940s, free-of-charge technical advisory and support service were promoted by the industry's press as a means to solve any kinds of fixing related issues. "A service that begins on a drawing board." Isn't it stunning that such a comprehensive approach to customer service is one of the foundations of our legacy? Heritage which allows us to respond to the needs of the present while curiously awaiting the future.



Conquest of the world

The initial 20 years of Rawlplug's operations were marked with global expansion. To be present in "every civilised country in the world" was John Joseph Rawlings's vision which he consistently pursued over the successive years. At the turn of the 1940s, the brand was present on all continents, completing the conquest of the United States and aiming at Australia. By that time, Rawlplug's products had already been manufactured in 10 countries, including London, New York, Paris or Zurich.

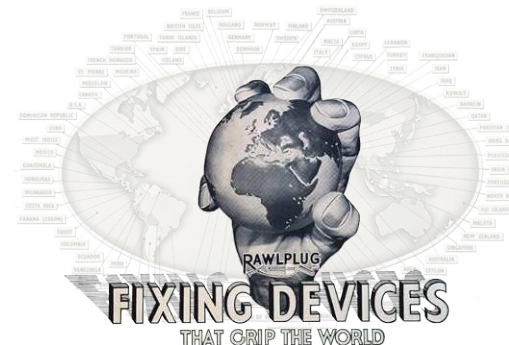



Products

100 years of expertise in fixings, fasteners and tools.

No other brand in the world manufactures and delivers to its customers products that cater to virtually every segment of the construction industry. Our offering consists of as many as 10 specialised product categories. We control every step in the manufacturing process, starting from designing performed by engineers collaborating with constructors, through prototyping and testing handled by the R&D Department, to production conducted in manufacturing plants which, in terms of technology, are surely among the most highly advanced and best automated factories in the world. For 100 years now, it has allowed us to deliver products that are universal, on the one hand, and on the other hand, which meet requirements of even the most highly specialised construction works, offer modern design and unique technical parameters, being easy to install and extremely durable in operation.



Mechanical anchors

Advanced technology for high load capacity and simplicity of use.

Bonded anchors

Uncompromising technical parameters and safety guaranteed in all applications.

Facade insulation fixings

Simplicity and speed of installation in innovative solutions for energy-saving buildings.

Roofing insulation fixings

System solutions ensuring efficient installation and long service life.

Lightweight fixings

Strength, versatility and simplicity of installation in all substrates and with any fixture.

Power tool accessories

Comprehensive and complementary portfolio of accessories for top-quality fixing solutions.

Fasteners

Highly specialised products dedicated to all materials and service conditions.

Manual and direct fastening systems

Portfolio of professional tools designed with time saving and fixing reliability in mind.

Foams and sealants

High efficiency and unparalleled universality in a wide range of products matching diverse applications.

Passive fire protection system

Product portfolio for uncompromising fire safety.

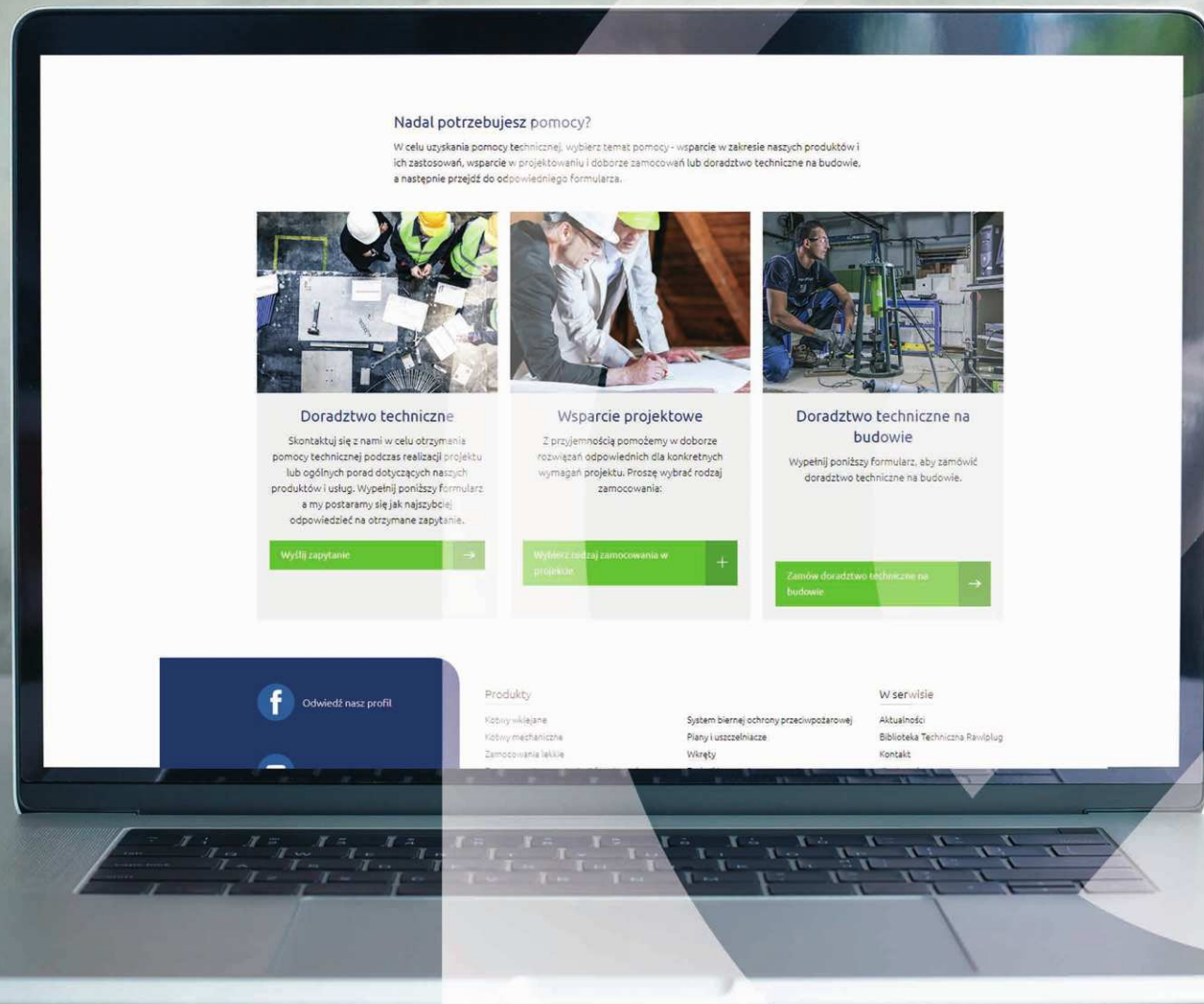

Services

We have genuine experts on board – specialists who cooperate on a daily basis to keep track of the actual needs of construction professionals.

They continuously seek to improve the Rawlplug® service package, focused on technical and design support for architects, constructors and contractors. They track even the most specific and ambitious expectations of customers, and successfully integrate them with our solutions. Rawlplug® has been investing in the development and improvement of tools intended to make your daily work easier and to enhance its comfort, efficiency and quality. And we haven't stopped there, since all our services are rendered at no extra charge.

OnsiteTechnicalSupport

TechnicalHelpdesk

TechnicalLibrary

ProductSelector

EasyFix

BIM

Construction Fixings Association

Rawlplug is a proud member of the Construction Fixings Association (CFA) which represents major fixings suppliers within the UK.

All CFA full members are committed to providing technically proven products manufactured to recognised quality assurance procedures and backed up with comprehensive technical support services including performance data, anchor selection software, application advice, on site testing and training in the correct use of our products.

The CFA is directly involved in the development of European and British Standards, contributing to the development of European Guidelines for Technical Approval of anchors. The CFA also ensures best fixings practice by publishing a series of free guidance notes, downloadable from the website which also carries articles, news and technical advice.

Technical Helpdesk

Consultations and technical/design support provided by the Technical Department's engineers, practitioners and market experts.

- Technical and design-related consultations with our Technical Department's engineers.
- Systematic and structured handling of problem-solving tasks thanks to forms dedicated to specific applications and products.
- Personalised design assistance with the specificity and requirements of individual solutions in mind.

HOW TO SUBMIT ENQUIRIES?

Enquiries are submitted via Rawlplug's website. You simply need to pick the right form, enter your data and information about your project, and submit the enquiry form. Our employees contact the website using the RTH tab of our corporate portal. The new format is user-friendly, and it provides our engineers with enhanced tools, since now they have access to all enquiries at one place.





Technical Support

Technical advisory provided by local engineering teams to tackle all technical challenges, particularly with regard to on-site strength testing of the Rawlplug® products under real life operating conditions.

Onsite Technical Support

Rawlplug® provides a comprehensive site testing service.

- Pull-out tests can be conducted on any of the products in the range, and are normally done on site in the actual structure. Alternatively, we can demonstrate the anchor performance with test blocks in another location. Engineers and contractors are encouraged to be present at the testing.

Testing is conducted in accordance with the guidelines of the Construction Fixings Association.

- The Construction Fixings Association (CFA) represents the major quality manufacturers of anchoring products, ensuring good practice at all times. Rawlplug is a founder member of the CFA and has its personnel on the Technical Committee, Promotions Committee and on the Board of Directors (Vice Chairman).
- Since the company was founded over 100 years ago, Rawlplug has been respected as a top quality manufacturer, this approach to quality and performance has never been compromised, even with competition from imported products.

Free Site Testing Service

- To encourage best practice, we offer the site testing service free of charge. Based on the information supplied by the structural engineer, civil engineer or other specifier, a number of pull-out tests will be conducted using the most appropriate fixings.
- These could include mechanical and bonded anchors, insulation fixings for facades and roofing, direct fasteners or lightweight fixings depending on the application.

Site Testing Results

- If the test results are inconsistent, more tests will be carried out to determine the structure's limitations.
- Rawlplug Engineers are qualified professionals with many years of experience and the client can fully rely on the outcome.
- The solution recommended will be the most economical one that will provide the performance required, based on all the information provided by the engineer or contractor and the test results achieved.
- A detailed site test report will be distributed to all interested parties shortly after the test is completed. This will include the names of those who witnessed the tests and all the information available including test load, load achieved, structure type, strength and thickness, fixture thickness and material type, etc.
- The Rawlplug engineer will include comments about the application, observations and recommendations based on all the data collected to ensure that a comprehensive report is available for future reference.



Product Selector

Appropriate selection of products to match specific applications by taking the project's requirements and particular requirements into account.

- Possibility to choose products from among 10 product categories in a selection-assisted process.
- Numerous convenient product browsing options relevant from the intended use perspective.
- Transparent and highly functional presentation of useful information.
- Option to enquire about product availability or specific properties.

Technical Library

Complete portfolio of technical documentation required to place the products on the market as well as to select and use them in the right manner.

- Option to pick from among 15 categories of information and documents required to make the right choice of the brand's products and to use them correctly.
- Complete set of product-specific technical and commercial documents.
- Original documents as well as documentation required for legal purposes, enabling distribution, designing and use of fixing solutions.



Tools for designers

Nowadays, the computer, and no longer the drawing board, is the basic working tool for architects, designers and other professionals in the construction industry.

Computer software and applications facilitate investment work at every stage, providing precise and fast calculations, selecting products and taking care of supplementing the relevant documentation. Rawlplug's original software – Rawlplug EasyFix and BIM Rawlplug – provides substantial assistance that will prove useful during the design stage, as well as during subsequent execution.

EasyFix

Design calculations required to plan fixings for diverse construction elements using Rawlplug® branded products.

- Proprietary and free-of-charge application for design calculations, responding to even the most specific requirements of construction investments.
- Divided into subject-specific modules dedicated to individual segments of construction works.
- Based on the latest EAD, ETAG and EUROCODE guidelines, ensuring that calculations conform to the standards, that they are precise and highly useful.
- Highly specialised features combined with simplicity and intuitiveness of use to support every designer and ensure safety of the solutions being designed.

ACCES TO EASYFIX

The EasyFix application is free to download and use. You can get the software from www.easyfix.rawlplug.com/en

BIM

Automatic implementation of models and technical drawings of the Rawlplug® fixings in the BIM/CAD design environment.

- Proprietary application enabling models and technical drawings of the Rawlplug® fixings to be downloaded and embedded in designs.
- Comprehensive sets of product data making design-related decisions easier.
- Models and drawings available in 2D and 3D, in 6 projections and the 360° view mode.
- Available on-line or ready to download and implement in the BIM/CAD environment.

ACCESS TO SOFTWARE

There are two ways to use the data contained in BIM Rawlplug:

Integration of BIM Rawlplug with Autodesk® Revit®

Integration of the data library with Autodesk® Revit® is possible thanks to the innovative Revit plug-in. You just need to download the plug-in from the rawlplug.com website. It is available in the Services/Design & Software tab.

Using on-line software

BIM Rawlplug is an application that can be downloaded from the Services/Design & Software tab on rawlplug.com. It may be used by anyone who intends to browse through and become familiar with the models, drawings and information the system provides, without being forced to register and subsequently log on.

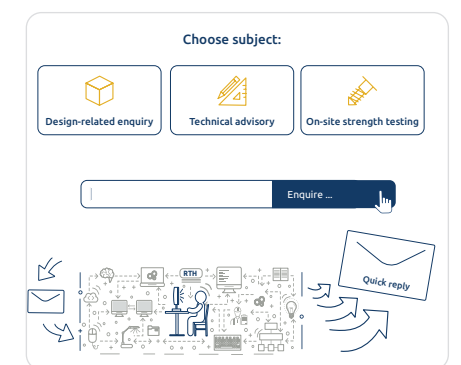
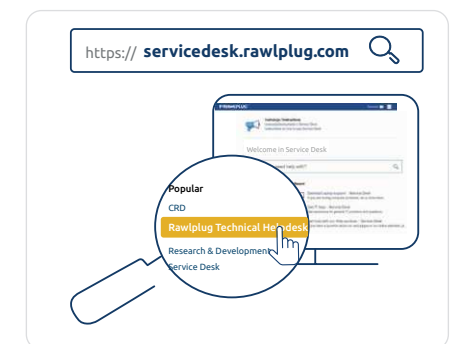
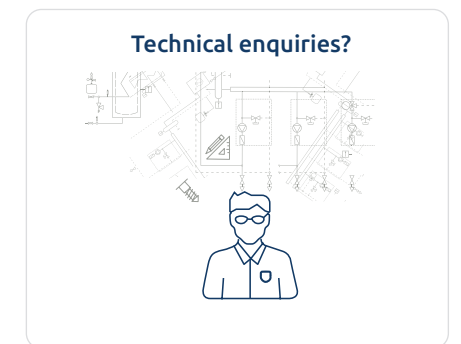

Check its advantages		RTH	E-MAIL
	Quick reply	✓	✗
	Entire conversation history at one place	✓	✗
	Easy-to-check project history, even after several years	✓	✗

* You can also contact us via <https://onerawlplug.com>





Training

Beyond highly specialised knowledge and experience based on practice, nothing can give you the real certainty of quality, durability and reliability of the outcomes of your work.

We have always been close to our customers for many reasons, such as to share the know-how and experience gathered over the last 100 years of our operations. Engineers, designers, contractors and salespeople could always count on our technical support. But today we give them even more, namely an innovative development programme dedicated to education and competence building, designed to actually cater to their daily needs, known as Rawlplug Academy®. The integration of Rawlplug Academy's four pillars, i.e. the e-learning platform, the Training Centre, traditional workshops and the knowledge base, makes it the most comprehensive and useful educational scheme in the sector of fixings and fasteners.



E-LEARNING platform

- Integrated training scheme covering industry-specific knowledge as well as Rawlplug's products and services that every professional will find indispensable, supporting them in tackling even the most ambitious challenges.
- Building development paths based on individual needs, the knowledge and skills already acquired as well as professional specialisation of the participants.
- Access to on-line training via a highly functional platform enabling you to join the training at any place and time.
- Development programmes dedicated to various groups of professionals: engineers, contractors, designers and representatives of the Trade & DIY sector.

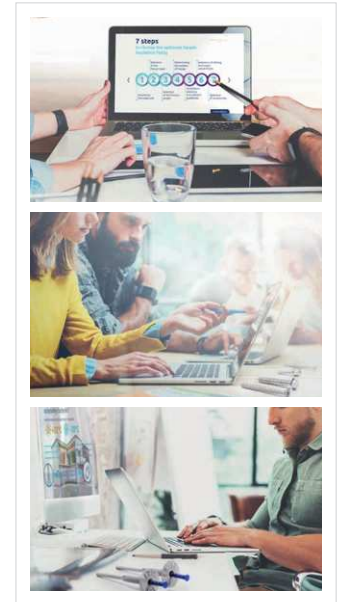



Classroom training

- Workshops devised in a way to consolidate and extend the knowledge acquired at e-learning courses.
- Meetings in small groups enabling the participants to talk about their typical and potential design and contracting challenges.
- Exchange of the most valuable experiences with market practitioners and experts responsible for shaping Rawlplug's product and service portfolio.
- Training modules designed and delivered by specialists with extensive experience in collaboration with designers, contractors and salespeople, responsible for developing individual product groups.



Training centre

- Modern training facility where you can experience and get to know Rawlplug's entire offering, comprising products, services and training.
- Possibility to select and use a full range of our products under conditions that closely reflect their real-life on-site application.
- Unique opportunity to get to know latest trend-setting Rawlplug® releases that go beyond even the most highly specific expectations of our customers.

Training Center Rawlplug Academy®
Products Zone



Training Center Rawlplug Academy®
Services Zone



Training Center Rawlplug Academy®
Testing Zone





Knowledge base

- Access to original materials prepared by recognised market experts relying on extensive experience, know-how and best practices.
- Materials that come in handy for every professional from the industry, regardless of their specialisation level.
- Attractiveness and utility value guaranteed by diversified forms of information presentation – both traditional and on-line.
- Tools intended for application in practice, in a broad range of design and construction works, and useful for those who wish to build their expert's position in the market during public appearances, training courses or trade meetings.



Technical product comparison based on approvals and declarations



Technical product benchmark based on lab tests



Installation movies



Design & specification guides



TYPES OF ANCHORS ▾

Torque-controlled expansion anchors

Applied loads are transferred to the substrate via friction between the anchor and the wall of the drilled hole. Friction is the result of expansion force, achieved by applying torque to the bolt or nut, thus drawing a cone component in to an expanding sleeve to create the anchorage.



Deformation-controlled expansion anchors

Applied loads are transferred to the substrate via friction between the anchor and the wall of the drilled hole. Friction is the result of expansion force, achieved by displacement of a wedge component, deforming the anchor body and creating the anchorage.



Concrete screw

Threaded fastener screwed into a predrilled hole where threads create a mechanical interlock with the concrete.



Undercut anchors

Applied load is transferred to the substrate by mechanical interlock – the result of interaction between the anchor form and the cavity form. The required cavity (or undercut) may be pre-formed within the substrate.



Bonded (injection) anchors

Applied loads are transferred to the substrate by adhesion at the anchor/resin and resin/substrate interfaces. Anchors are supplied as a two-piece set, containing resin (in capsule or cartridge form) and a steel element. In cases involving hollow substrates, a plastic or metal mesh sleeve may be introduced as a third system component. Bonded anchors minimise the introduction of stresses in the substrate material, due to the absence of expansion forces.



Basics
to anchoring



BASICS OF ANCHORING - ANCHOR SELECTION FACTORS

In order to select and install an anchor correctly, the user should consider the following factors:

- » Environmental conditions (humidity, chemicals, etc.), which are the most important factor for selection of the material and coating type of the fastener (corrosion resistance)
- » Base material (type of concrete, solid or hollow masonry structures) – some products (R-KEM II, for example) are suitable for a wide range of substrates, whilst others are recommended for only one
- » Anchor spacing and edge distances - Consideration must be given to the minimum distances required to avoid damaging the substrate

- » Load-bearing capacity - Data (much of which stems from technical approvals) is provided for each product presented in this catalogue
- » Loading type (static/dynamic) and direction (tension/shear/combined)
- » Setting data – embedment depths, installation guidelines, etc.

Expanded detail of each of these main selection factors is presented in the following sections.

CORROSION

Corrosion is one of the most important and influential factors in the selection of anchors. Two basic corrosion types must be considered: atmospheric and galvanic corrosion.

Galvanic corrosion may occur when two dissimilar metals are in contact with each other. In the presence of an electrolyte (e.g. water) a galvanic cell is created, causing gradual corrosion of one of the metal elements.

The table below shows metals that may commonly be used as connector (anchor) and/or fixture materials, with indications of the expected corrosion outcome for each possible combination: - the first column lists the fixed element (fixture) material - the top row lists the anchor/connector material

Comments:

- » Metal of the fixed element is not exposed to galvanic corrosion and, in fact, it takes advantage of galvanic protection (low, when the difference of electrochemical potentials is low, higher as the difference of potentials increases).

- » The galvanic effect is influenced by the comparative surface areas of the two metals:
 - in cases where the surface area of the fixture is the lesser, corrosion is accelerated
 - in cases where the surface area of the fixture is the greater, corrosion is slowed.

The effect becomes more pronounced as the difference between the two surface areas increases.

Connector metal >	Stainless steel	Hot dip galvanised steel	Zinc electroplated steel	Zinc alloys	Lead	Brass
Fixture metal v						
Stainless steel	■	↑	↑	↑	↑	↑
Hot dip galvanised steel	←	■	■	■	←	←
Zinc electroplated steel	←	■	■	■	■	←
Low carbon steel	←	↑	↑	↑	■	←
Aluminium alloys	←	↑	↑	↑	■	■
Zinc alloys	←	■	■	■	←	←

■ Contact between these metals is allowable ↑ The connector metal will corrode ← The fixture metal will corrode

BASICS OF ANCHORING - TYPES OF ANCHORS

Atmospheric corrosion is caused by the interaction of moisture or chemical compounds from the air with exposed metal. Corrosion rates depend on the concentration of chemical compounds in the air, as well as humidity levels.

According to ISO 12944-2:1998 (Table 1), atmospheric corrosion categories can be differentiated depending on locality, as well as the prevailing conditions. It is therefore important to accurately determine the working conditions of designated fixings and materials to ensure their correct application.

BASICS OF ANCHORING - TYPES OF ANCHORS

Atmospheric corrosion classification Corrosion categories	Typical environments		Recommended material			
	External	Internal	Zinc plating	Zinc flake	A2	A4
C1 Very low	–	Interior of air-conditioned premises with clean atmosphere (e.g. shops, offices, hotels)	5-10 µm	■	■	■
C2 Low	Atmosphere with low pollution and dry climate; mainly rural areas	Unheated buildings where condensation may occur (e.g. warehouses)	5-10 µm	■	■	■
C3 Moderate	Residential and industrial atmosphere with moderate pollution of SO ₂ ; Coastal areas; low salinity atmosphere	Light industry with humidity and air pollution (food production, laundry facilities, etc.)	40 µm	■	□	■
C4 High	Industrial and coastal areas; medium salinity atmosphere	Chemical factories, swimming pools, offshore ships, etc.	40 µm	■	–	■
C5-I/M Very high (marine)	Coastal and offshore areas with highly-aggressive atmospheric conditions of high salinity and humidity	Buildings and areas with condensation of water and high pollution	40 µm	□	–	■

■ suitable for use □ consultation with our technical advisor recommended – not suitable for use

For anticorrosion protection RAWLPLUG® use not only standard technologies like zinc electroplating, but also more advanced alternatives. These include traditional protective measures such as hot dip galvanizing, or the use of stainless steel as the primary material. Modern protective technologies, like Deltatone or similar zinc flake coatings, are utilised also. Images below show comparisons of zinc flake coated and hot dip galvanized samples after neutral salt Spray testing. Samples were installed in concrete cubes and placed in a corrosion testing chamber for 960 hours, with images showing sample condition after 504 hours, as well as 960 hours when the anchors were extracted from the substrate.



ZINC FLAKE COATING
Zinc electroplated expander
HPTIZF

HDG
Stainless steel expander
XPT-HDG

BASICS OF ANCHORING - LOADING CONSIDERATIONS

Moreover, fasteners and fixings offered by RAWLPLUG® are tested in high salinity atmospheric conditions on a regular basis. The tests constitute a foundation for product development in cooperation with our customers.

All of our metal anchors for applications in low corrosion risk environments are zinc electroplated and passivated. In cases where anchors are intended for use in higher risk environments we recommend hot dip galvanized, zinc flake or stainless steel products.

LOADING DIRECTIONS:

1. Axial tensile load – Load application is in the direction of the connector axis, acting to pull the connector away from the substrate.
2. Axial compressive load – Load application is in the direction of the connector axis, acting to clamp the connector onto the substrate.
3. Shear (transverse) load – Loading direction is perpendicular to connector axis, with the load applied at the substrate surface (fixture tightened against the substrate).
4. Combined load (resultant) occurs when axial and shear loads are acting simultaneously.
5. Bending moment occurs when a shear load is applied offset from the substrate surface. Magnitude of bending moment is dependent on applied load and lever arm length.

DESIGN OF FASTENING FOR USE IN CONCRETE

TERMS AND DEFINITIONS (ACC. EN 1990)

PERSISTENT DESIGN SITUATION	Design situation that is relevant during a period of the same order as the design working life of the structure. NOTE Generally it refers to conditions of normal use.
ACTION (F)	a) Set of forces (loads) applied to the structure (direct action); b) Set of imposed deformations or accelerations caused for example, by temperature changes, moisture variation, uneven settlement or earthquakes (indirect action).
PERMANENT ACTION (G)	Action that is likely to act throughout a given reference period and for which the variation in magnitude with time is negligible, or for which the variation is always in the same direction (monotonic) until the action attains a certain limit value.), e.g. self-weight of structures, fixed equipment and road surfacing, and indirect actions caused by shrinkage and uneven settlements
VARIABLE ACTION (Q)	Action for which the variation in magnitude with time is neither negligible nor monotonic, e.g. imposed loads on building floors, beams and roofs, wind actions or snow loads ;
ACCIDENTAL ACTION (A)	Action, usually of short duration but of significant magnitude, that is unlikely to occur on a given structure during the design working life. An accidental action can be expected in many cases to cause severe consequences unless appropriate measures are taken. NOTE 1 Certain actions, such as seismic actions and snow loads, may be considered as either accidental and/or variable actions, depending on the site location, see EN 1991 and EN 1998. NOTE 2 Actions caused by water may be considered as permanent and/or variable actions depending on the variation of their magnitude with time.
STATIC ACTION	Action that does not cause significant acceleration of the structure or structural members
QUASI-STATIC ACTION	Dynamic action represented by an equivalent static action in a static model
CHARACTERISTIC VALUE OF AN ACTION (F_k)	Principal representative value of an action NOTE: In so far as a characteristic value can be fixed on statistical bases, it is chosen so as to correspond to a prescribed probability of not being exceeded on the unfavourable side during a „reference period“ taking into account the design working life of the structure and the duration of the design situation.
DESIGN VALUE OF AN ACTION (F_d)	Value obtained by multiplying the representative value by the partial factor γ_f NOTE The product of the representative value multiplied by the partial factor $\gamma_f = \gamma_{sd} \cdot \gamma_f$ may also be designated as the design value of the action.
RECOMMENDED VALUE OF AN ACTION (F_{rec})	Maximum working load recommended by a manufacturer. Value obtained by multiplying the design value by the global safety factor $\gamma_F = 1,4$ according to BS 8539.
FIRE DESIGN RESISTANCE (R_{d,fi})	Design resistance in the fire situation; $R_{d,fi}(t)$ at a given time t. R 30 or R 60,... - fire resistance class for the load-bearing criterion for 30, or 60... minutes in standard fire exposure.
SEISMIC DESIGN SITUATION	Design situation involving exceptional conditions of the structure when subjected to a seismic event.

DESIGN OF FASTENINGS IN CONCRETE IN ACCORDANCE WITH EN 1992-4:2018

General design concept is based on partial safety factors, where the basis for designing the correct connection is the fulfillment of the condition:

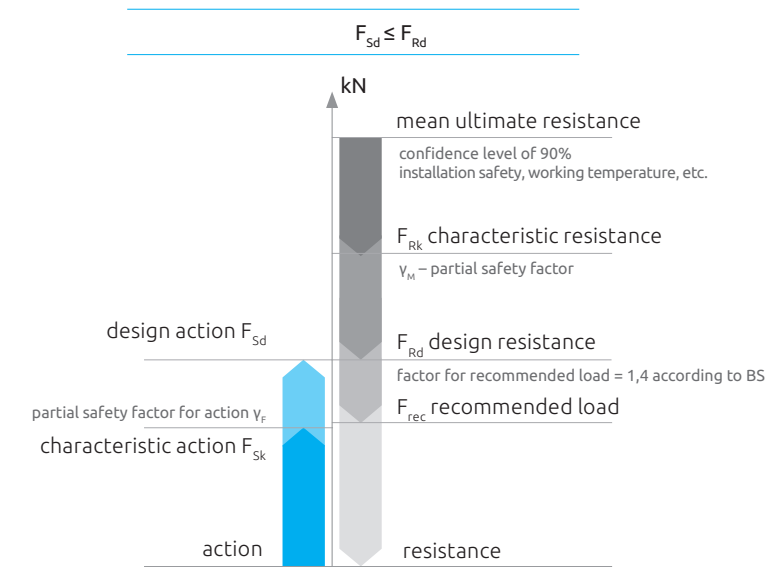

PARTIAL SAFETY FACTORS

ACTIONS

Partial factors shall be appropriate with EN 1990.

Persistent and Transient design situations	Permanent actions		Leading variable action	Accompanying variable actions (*)	
	Unfavourable	Favourable		Main (if any)	Others
(Eq. 6.10)	$\gamma_{Gj,sup} G_{kj,sup}$	$\gamma_{Gj,inf} G_{kj,inf}$	$\gamma_{Q,1} Q_{k,1}$	-	$\gamma_{Qi} \psi_{0,i} Q_{k,i}$
(Eq. .10a)	$\gamma_{Gj,sup} G_{kj,sup}$	$\gamma_{Gj,inf} G_{kj,inf}$	-	$\gamma_{Q,1} \psi_{0,1} Q_{k,1}$	$\gamma_{Qi} \psi_{0,i} Q_{k,i}$
(Eq. .10b)	$\xi \gamma_{Gj,sup} G_{kj,sup}$	$\gamma_{Gj,inf} G_{kj,inf}$	$\gamma_{Q,1} Q_{k,1}$	-	$\gamma_{Qi} \psi_{0,i} Q_{k,i}$

NOTE 1

The choice between 6.10, or 6.10a and 6.10b will be in the National annex. In case of 6.10a and 6.10b, the National annex may in addition modify 6.10a to include permanent actions only.

NOTE 2

The γ and ξ values may be set by the National annex. The following values for γ and ξ are recommended when using expressions 6.10, or 6.10a and 6.10b.

- $\gamma_{Gj,sup} = 1,35$
- $\gamma_{Gj,inf} = 1,00$
- $\gamma_{Q,1} = 1,50$ where unfavourable (0 where favourable)
- $\gamma_{Q,i} = 1,50$ where unfavourable (0 where favourable)
- $\xi = 0,85$ (so that $\xi \gamma_{Gj,sup} = 0,85 \times 1,35 \approx 1,15$).

See also EN 1991 to EN 1999 for γ values to be used for imposed deformations.

NOTE 3

The characteristic values of all permanent actions from one source are multiplied by $\gamma_{G,sup}$ if the total resulting action effect is unfavourable and $\gamma_{G,inf}$ if the total resulting action effect is favourable. For example, all actions originating from the self weight of the structure may be considered as coming from one source ; this also applies if different materials are involved.

NOTE 4

For particular verifications, the values for γ_c and γ_q may be subdivided into γ_g and γ_q and the model uncertainty factor γ_{sd} . A value of γ_{sd} in the range 1,05 to 1,15 can be used in most common cases and can be modified in the National annex.

RESISTANCE

Partial safety factors should be in accordance with EN 1992-4: 2018.

Failure modes	Partial safety factor	
Steel failure		
Tension		$= 1,2 \cdot f_{yk} / f_{yk} \geq 1,4$
Shear with and without lever arm	γ_{Ms}	$= 1,0 \cdot \frac{f_{yk}}{f_{yk}} \geq 1,25$ when $f_{yk} \leq 800 N/mm^2$ and $f_{yk} / f_{yk} \leq 0,8$ $= 1,5$ when $f_{yk} > 800 N/mm^2$ or $f_{yk} / f_{yk} > 0,8$
Steel failure – supplementary reinforcement		
Tension	$\gamma_{Ms,re}$	$= 1,15$ in acc. with EN 1992-1-1

Steel failure - exposure to fire			
Tension and Shear with and without lever arm	$V_{Ms,fi}$		= 1,0
Concrete related failure			
Concrete cone failure and concrete edge failure	V_{Mc}		= $V_c \cdot V_{inst}$
	V_c		= 1,5 in accordance with EN 1992-1-1
and concrete blow-out failure and concrete pry-out failure	V_{inst}		for seismic repair and strengthening of existing structures see the EN 1998 series ≥ 1,0 for post-installed fasteners in tension, is given in the relevant European Technical Product Specification. = 1,0 for post-installed fasteners in shear
Concrete splitting failure	V_{Msp}		= V_{Mc}
Concrete related failure - exposure to fire			
Concrete cone failure and concrete edge failure and concrete blow-out failure and concrete pry-out failure	$V_{Mc,fi}$		= $V_{(c,fi)} \cdot V_{inst}$
	$V_{c,fi}$		= 1,0 in accordance with EN 1992-4
	V_{inst}		≥ 1,0 for post-installed fasteners in tension, is given in the relevant European Technical Product Specification. = 1,0 for post-installed fasteners in shear
Concrete splitting failure	$V_{Msp,fi}$		= $V_{(Mc,fi)}$
Pull-out and combined pull-out and concrete failure	$V_{Mp,fi}$		= $V_{(Mc,fi)}$

NOTE 1
Partial factors for materials for exposure to fire for exposure to fire $v_{M,fi}$ may be found in a Country's National Annex to EN 1992-4.

STATIC AND QUASI-STATIC LOADS
REQUIRED VERIFICATION FOR FASTENERS IN TENSION



$$A_s \cdot f_{uk}$$

This is a break of the steel element of the fastener with no damage to the substrate or total pull-out of the fastener due to the tension force. The most important factors that affect the fastener's steel strength are: the ultimate tensile strength of the steel and the cross-sectional area of the fastener measured in the narrowest section.

Failure mode	Single fastener	Group of fasteners	
		most loaded fasteners	group
Steel failure of fastener	$N_{Ed} \leq N_{Rd,s} = \frac{N_{Rk,s}}{V_{Ms}}$	$N_{Ed}^h \leq N_{Rd,s} = \frac{N_{Rk,s}}{V_{Ms}}$	-

$$N_{Rk,s} = A_s \cdot f_{uk}$$

$N_{Rk,s}$ characteristic value of steel resistance of a fastener under tension load
 A_s effective cross-sectional area of the fastener in tension
 f_{uk} nominal characteristic steel ultimate tensile strength

Concrete cone failure

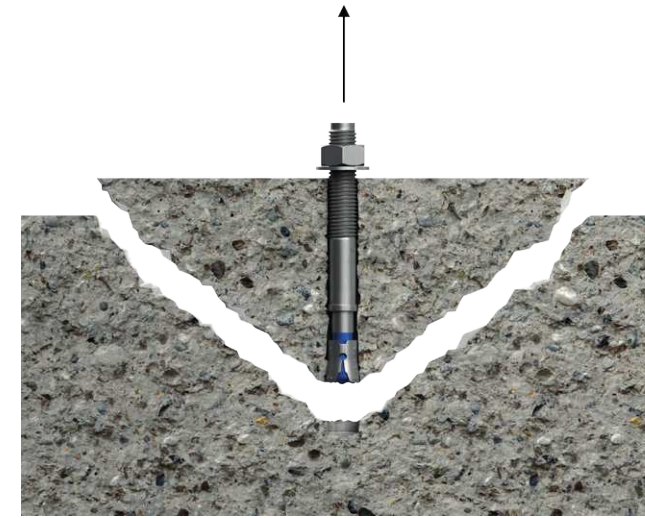

$$f_{ck} \cdot h_{ef}$$

It is concrete failure by breaking a piece of concrete in the shape of a cone due to the tension load. The direct cause of damage are high stresses in concrete resulting from the action of tensile forces on the fastener. The forces are transferred from the fastener to the substrate by mechanical expansion of the fastener, undercutting of the substrate, or adhesion forces. The main factors affecting the bearing capacity of the substrate are: the compressive strength of the concrete and effective embedment depth of anchor.

Failure mode	Single fastener	Group of fasteners	
		most loaded fasteners	group
Concrete cone failure	$N_{Ed} \leq N_{Rd,c} = \frac{N_{Rk,c}}{V_{Ms}}$	-	$N_{Ed}^g \leq N_{Rd,c} = \frac{N_{Rk,c}}{V_{Ms}}$

$$N_{Rk,c} = N_{Rk,c}^0 \cdot \frac{A_{c,N}}{A_{c,N}^0} \cdot \psi_{s,N} \cdot \psi_{re,N} \cdot \psi_{ec,N} \cdot \psi_{M,N}$$

$$N_{Rk,c}^0 = k_1 \cdot \sqrt{f_{ck}} \cdot h_{ef}^{1,5}$$

$N_{Rk,c}$ characteristic resistance in case of concrete cone failure under tension load
 k_1 factor taking into account the effect of the compressed and expanded concrete zone
 f_{ck} nominal characteristic compressive cylinder strength
 h_{ef} effective embedment depth in concrete
 $A_{c,N}/A_{c,N}^0$ reduction factor, taking into account the real surface area of the anchor's impact in the substrate in the case of a group of fasteners or the presence of concrete edges within the range of the fastener's impact.
 $\psi_{s,N}, \psi_{re,N}, \psi_{ec,N}, \psi_{M,N}$ reduction factors, taking into account the impact of: concrete edges; dense surface reinforcement in concrete; asymmetrical distribution of forces in the anchor group; clamping force between the base plate and the substrate in case of bending moment.

Pull-out failure



test

It is the total pull-out of the mechanical fastener without damaging the concrete due to the tension force. The anchor's efficiency is directly influenced by the effectiveness of anchoring in the concrete by mechanical locking. The pull-out of the fastener occurs when the force of the fastener impact on the substrate is less than the load capacity of the substrate - the concrete cone. The main factor affecting the load capacity is the fastener structure.

Failure mode	Single fastener	Group of fasteners	
		most loaded fasteners	group
Pull-out failure of fastener ^a	$N_{Ed} \leq N_{Rd,p} = \frac{N_{Rk,p}}{V_{Mp}}$	$N_{Ed}^h \leq N_{Rd,p} = \frac{N_{Rk,p}}{V_{Mp}}$	-

^a Not required for post-installed bonded fasteners.

$N_{Rk,p}$ characteristic resistance in case of pull-out failure under tension load

Combined pull-out and concrete failure
(in case of post-installed bonded fasteners)



$$\tau_{Rk} \quad h_{ef} \quad d$$

It is the total pull-out of the adhesive bond with surface damage of the substrate due to the tension force. The anchoring effect is directly influenced by the effectiveness of anchoring in the substrate through the use of adhesive forces. The pull-out of the fastener occurs when the force of the fastener interaction on the substrate is less than the load capacity of the substrate - the concrete cone. The main factors affecting the load capacity of the fastener are: resin strength, anchorage depth and fastener diameter.

Failure mode	Single fastener	Group of fasteners	
		most loaded fasteners	group
Combined pull-out and concrete failure ^b	$N_{Ed} \leq N_{Rd,p} = \frac{N_{Rk,p}}{V_{Mp}}$	-	$N_{Ed}^g \leq N_{Rd,p} = \frac{N_{Rk,p}}{V_{Mp}}$

^b Not required for headed and post-installed mechanical fasteners.

$$N_{Rk,p} = N_{Rk,p}^0 \cdot \frac{A_{c,N}}{A_{c,N}^0} \cdot \psi_{g,Np} \cdot \psi_{s,Np} \cdot \psi_{re,N} \cdot \psi_{ec,Np}$$

$$N_{Rk,p}^0 = \psi_{sus} \cdot \tau_{Rk} \cdot \pi \cdot d \cdot h_{ef}$$

$N_{Rk,p}$ characteristic resistance in case of combined pull-out and concrete failure under tension load

ψ_{sus} factor that takes account of the influence of sustained load

τ_{Rk} characteristic bond resistance

d outer diameter of fastener

h_{ef} effective embedment depth in concrete

$A_{c,N}/A_{c,N}^0$ reduction factor, taking into account the real surface area of the anchor's impact in the substrate in the case of a group of fasteners or the presence of concrete edges within the range of the fastener's impact.

$\psi_{g,Np}$, $\psi_{s,Np}$, $\psi_{re,Np}$, $\psi_{ec,Np}$ reduction factors taking into account the impact of: groups of fasteners placed close to each other; concrete edges; dense surface reinforcement in concrete; asymmetrical distribution of forces in the anchor group.

Splitting failure



$$N_{Rk,p}^0 \quad N_{Rk,c}^0$$

It is concrete damage due to linear cracking of the concrete as a result of tension forces. The direct cause of damage is the proximity of the fastener to the concrete edge and high stresses in concrete resulting from the effects of tensile forces on the fastener. Calculations are not necessary, either with the appropriate thickness of the substrate and when the edges of the concrete are outside the zone of impact of the fasteners, or if the destruction by breaking out and the concrete cone is calculated for cracked concrete, and the substrate has appropriate reinforcement limiting the width of the crack. The main factors affecting the load capacity of the fastener when splitting concrete are: pull-out resistance and concrete cone resistance.

Failure mode	Single fastener	Group of fasteners	
		most loaded fasteners	group
Concrete splitting failure	$N_{Ed} \leq N_{Rd,sp} = \frac{N_{Rk,sp}}{V_{Msp}}$	-	$N_{Ed}^g \leq N_{Rd,sp} = \frac{N_{Rk,sp}}{V_{Msp}}$

$$N_{Rk,sp} = N_{Rk,sp}^0 \cdot \frac{A_{c,N}}{A_{c,N}^0} \cdot \psi_{s,N} \cdot \psi_{re,N} \cdot \psi_{ec,N} \cdot \psi_{h,sp}$$

$$N_{Rk,sp}^0 = \min(N_{Rk,p}^0, N_{Rk,c}^0)$$

$N_{Rk,sp}$ characteristic resistance in case of concrete splitting failure under tension load

$N_{Rk,p}^0$ characteristic resistance in case of pull-out failure of a single fastener not influenced by adjacent bonded fasteners or edges of the concrete member

$N_{Rk,c}^0$ characteristic resistance in case of concrete cone failure of a single fastener not influenced by adjacent bonded fasteners or edges of the concrete member

$A_{c,N}/A_{c,N}^0$ reduction factor, taking into account the real surface area of the anchor's impact in the substrate in the case of a group of fasteners or the presence of concrete edges within the range of the fastener's impact.

$\psi_{s,N}$, $\psi_{re,N}$, $\psi_{ec,N}$, $\psi_{h,sp}$ reduction factors taking into account the impact of: concrete edges; dense surface reinforcement in concrete; asymmetrical distribution of forces in the base plate; substrate thickness.

Blow-out failure



$$c_1 \quad A_h \quad f_{ck}$$

This is concrete damage by blow-out the side of the concrete at the edge. This damage due to the characteristics of the fastener action is considered only for headed anchors and undercut mechanical anchors acting as headed anchors. The main factors affecting the load capacity of the fastener when blow-out concrete are: distance from the edge of the concrete, the surface of the fastener head impact on the concrete and the strength of the concrete.

Failure mode	Single fastener	Group of fasteners	
		most loaded fasteners	group
Concrete blow-out failure ^c	$N_{Ed} \leq N_{Rd,cp} = \frac{N_{Rk,cp}}{V_{Mc}}$	-	$N_{Ed} \leq N_{Rd,cp} = \frac{N_{Rk,cp}}{V_{Mc}}$

^c Not required for post-installed mechanical and bonded fasteners – except mechanical undercut fasteners

$$N_{Rk,cb} = N_{Rk,cb}^0 \cdot \frac{A_{c,Nb}}{A_{c,Nb}^0} \cdot \psi_{s,Nb} \cdot \psi_{g,Nb} \cdot \psi_{ec,Nb}$$

$$N_{Rk,cb}^0 = k_s \cdot c_1 \cdot \sqrt{A_h} \cdot \sqrt{f_{ck}}$$

- $N_{Rk,cb}$ characteristic resistance in case of concrete blow-out failure under tension load
- k_s factor taking into account the effect of the compressed and expanded concrete zone
- c_1 distance of the fastener from the edge of the concrete
- A_h the surface of the fastener head impact on the concrete
- f_{ck} nominal characteristic compressive cylinder strength
- $A_{c,Nb}/A_{c,Nb}^0$ reduction factor, taking into account the real surface area of the anchor's impact in the substrate in the case of a group of fasteners or the presence of concrete edges within the range of the fastener's impact.
- $\psi_{s,Nb}, \psi_{g,Nb}, \psi_{ec,Nb}$ reduction factors taking into account the impact of: concrete edges; groups of anchors parallel to the edges of the concrete; asymmetrical distribution of forces in the anchor group.

REQUIRED VERIFICATION FOR FASTENERS IN SHEAR

Steel failure without lever arm



$$A_s \quad f_{uk}$$

It is cutting the steel element of the fastener with no damage to the concrete or total extension of the fastener due to the shear force. The most important factors that affect the fastener's steel strength are: the ultimate tensile strength of the steel and the fastener's cross-sectional area measured at the potential shear.

Failure mode	Single fastener	Group of fasteners	
		most loaded fasteners	group
Steel failure of fastener without lever arm	$V_{Ed} \leq V_{Rd,s} = \frac{V_{Rk,s}}{V_{Ms}}$	$V_{Ed}^h \leq V_{Rd,s} = \frac{V_{Rk,s}}{V_{Ms}}$	-

$$V_{Rk,s}^0 = k_6 \cdot A_s \cdot f_{uk}$$

$$V_{Rk,s} = k_7 \cdot V_{Rk,s}^0$$

- $V_{Rk,s}$ characteristic value of steel resistance of a fastener under shear load
- k_7 factor taking into account the load effect in the anchor group and the ductile steel class
- k_6 factor taking into account the steel tensile strength class
- A_s stressed cross section of a fastener
- f_{uk} nominal characteristic steel ultimate tensile strength

Steel failure with lever arm



$$M_{Rk,s} \quad l_a$$

It is a deformation of the steel element of the fastener with no damage to the concrete or total extension of the fastener due to the shear force. The most important factors that affect the strength of the fastener steel are: the bending moment of the fastener and the length of the arm to the force.

Failure mode	Single fastener	Group of fasteners	
		most loaded fasteners	group
Steel failure of fastener without lever arm	$V_{Ed} \leq V_{Rd,s,M} = \frac{V_{Rk,s,M}}{V_{Ms}}$	$V_{Ed}^h \leq V_{Rd,s,M} = \frac{V_{Rk,s,M}}{V_{Ms}}$	-

$$V_{Rk,s,M} = \frac{\alpha_M \cdot M_{Rk,s}}{l_a}$$

$V_{Rk,s,M}$ characteristic resistance in case of steel failure with lever arm under shear

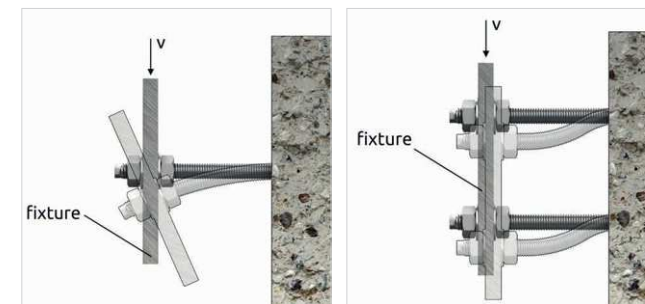

$\alpha_M = 1.0$ when element (fixture) is not fixed and can rotate freely
 $\alpha_M = 2.0$ when element (fixture) is fixed and cannot rotate

α_M factor accounting for the degree of restraint of the fastener at the side of the fixture of the application in question. It should be determined according to good engineering practice.

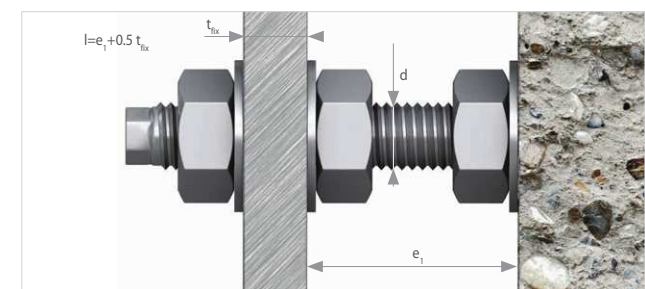

stand-off installation

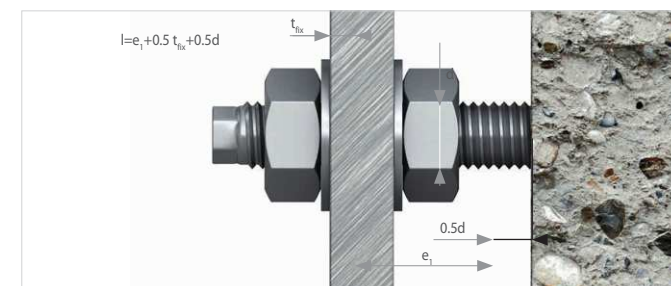

stand-off installation with nut and washer to prevent local concrete spalling

- $l_a = a_3 + e_1$ length of the effective lever arm of the shear force
- e_1 is the distance between shear load and concrete surface neglecting the thickness of any levelling grout
- $a_3 = 0,5 d_{nom}$
 = 0 if a washer and a nut are directly clamped to the concrete surface or to the surface of an anchor channel
 or if a levelling grout layer with a compressive strength $\geq 30 \text{ N/mm}^2$ and a thickness $t_{grout} \leq d/2$ is present.

Concrete pry-out failure

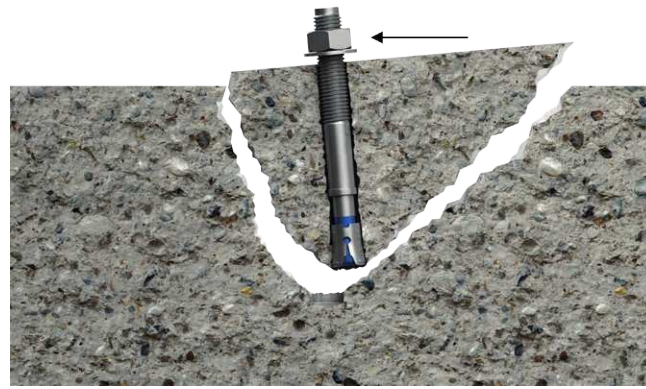

$$N_{Rk,c} \quad N_{Rk,p}$$

It is concrete damage by breaking a piece of concrete in the shape of a half cone due to the shear force. The direct cause of damage is high stress in concrete resulting from shear forces on the fastener. The main factor affecting the load capacity of the fastener during pry-out is the load capacity of the concrete cone or load capacity of pull-out.

Failure mode	Single fastener	Group of fasteners	
		most loaded fasteners	group
Concrete pry-out failure	$V_{Ed} \leq V_{Rd,cp} = \frac{V_{Rk,cp}}{V_{Ms}}$	-	$V_{Ed}^g \leq V_{Rd,cp} = \frac{V_{Rk,cp}}{V_{Mc}}$

$$V_{Rk,cp} = k_8 \cdot N_{Rk,c}$$

$V_{Rk,cp}$ characteristic resistance in case of concrete pry-out failure under shear load

k_8 factor taking into account the fastener embedment depth

$N_{Rk,c} = N_{Rk,c}$	for mechanical anchors
$N_{Rk,c} = \min(N_{Rk,c}; N_{Rk,p})$	for bonded anchors

Concrete edge failure



$$d_{nom} \quad l_f \quad c_1$$

It is concrete damage by tearing off the edge of the concrete due to the shear force. The direct cause of damage is high stress in concrete resulting from shear forces on the fastener. The main factors affecting the load capacity of the fastener in case of concrete edge failure are: the fastener diameter, the effective embedment length of anchor and the edge distance from the fastener.

Failure mode	Single fastener	Group of fasteners	
		most loaded fasteners	group
Concrete edge failure	$V_{Ed} \leq V_{Rd,c} = \frac{V_{Rk,c}}{V_{Ms}}$	-	$V_{Ed}^g \leq V_{Rd,c} = \frac{V_{Rk,c}}{V_{Ms}}$

$$V_{Rk,c} = V_{Rk,c}^0 \cdot \frac{A_{cV}}{A_{cV}^0} \cdot \psi_{sV} \cdot \psi_{hV} \cdot \psi_{ecV} \cdot \psi_{aV} \cdot \psi_{reV}$$

$$V_{Rk,c}^0 = k_9 \cdot d_{nom}^\alpha \cdot l_f^\beta \cdot \sqrt{f_{ck}} \cdot c_1^{1,5}$$

$$\alpha = 0,1 \left(\frac{l_f}{c_1}\right)^{0,5} \quad \beta = 0,1 \left(\frac{d_{nom}}{c_1}\right)^{0,2}$$

$V_{Rk,c}$	characteristic resistance in case of concrete edge failure under shear load
k_9	factor taking into account the effect of the compressed and expanded concrete zone
f_{ck}	nominal characteristic compressive cylinder strength
d_{nom}	outside diameter of a fastener
l_f	effective embedment length of fastener
c_1	edge distance from the fastener
A_{cV}/A_{cV}^0	reduction factor, taking into account the real surface area of the anchor's impact in the substrate in the case of a group of fasteners or the presence of concrete edges within the range of the fastener's impact.
$\psi_{sV}, \psi_{hV}, \psi_{ecV}, \psi_{aV}, \psi_{reV}$	reduction factors taking into account the impact of: edge distance; thickness of concrete member; asymmetrical distribution of forces in the base plate; no perpendicular application of shear force to the concrete edge; reinforcement located on the edge.

COMBINED TENSION AND SHEAR LOADS

Failure mode	Verification	
	Fastenings without supplementary reinforcement	Fastenings with supplementary reinforcement
1 Steel failure of fastener ^a	$\left(\frac{N_{Ed}}{N_{Rd,s}}\right)^2 + \left(\frac{V_{Ed}}{V_{Rd,s}}\right)^2 \leq 1$ and $N_{Ed}/N_{Rd,s} \leq 1$ and $V_{Ed}/V_{Rd,s} \leq 1$	
2 Failure modes other than steel failure	$\left(\frac{N_{Ed}}{N_{Rd,i}}\right)^{1,5} + \left(\frac{V_{Ed}}{V_{Rd,i}}\right)^{1,5} \leq 1$ or $\left(\frac{N_{Ed}}{N_{Rd,i}}\right) + \left(\frac{V_{Ed}}{V_{Rd,i}}\right) \leq 1,2$ and $N_{Ed}/N_{Rd,i} \leq 1$ and $V_{Ed}/V_{Rd,i} \leq 1$	$\left(\frac{N_{Ed}}{N_{Rd,i}}\right)^{1,5} + \left(\frac{V_{Ed}}{V_{Rd,i}}\right)^{1,5} \leq 1$ and $N_{Ed}/N_{Rd,i} \leq 1$ and $V_{Ed}/V_{Rd,i} \leq 1$

^a This verification is not required in case of shear load with lever arm



FIRE DESIGN

The design method covers fasteners with a fire exposure from one side only. For fire exposure from more than one side, the design method may be used only, if the edge distance of the fastener

is both, $c \geq 300$ mm and $c \geq 2h_{ef}$. If characteristic resistances under fire exposure are not available in a European Technical Product Specification the conservative values given below may be used.

REQUIRED VERIFICATION FOR FASTENERS IN TENSION

Steel failure

The characteristic tension strength $\sigma_{Rk,s,fi}$ of a fastener in case of steel failure under fire exposure given in the following Tables D.1 and D.2 is valid for the unprotected steel part of the fastener outside the concrete and may be used in the design. The characteristic resistance $N_{Rk,s,fi}$ is obtained as:

$$N_{Rk,s,fi} = A_s \cdot \sigma_{Rk,s,fi}$$

Fastener bolt/thread diameter	Embedment depth h_{ef} [mm]	Characteristic tension strength $\sigma_{Rk,s,fi}$ [N/mm ²] of an unprotected fastener made of carbon steel according to the EN 10025 series in case of fire exposure			
		30 min (R15 to R30)	60 min (R45 to R60)	90 min (R90)	120 min (\leq R120)
Ø6	≥ 30	10	9	7	5
Ø8	≥ 30	10	9	7	5
Ø10	≥ 40	15	13	10	8
Ø12 and greater	≥ 50	20	15	13	10

Table D.1 - Characteristic tension strength of a carbon steel fastener under fire exposure

Fastener bolt/thread diameter	Embedment depth h_{ef} [mm]	Characteristic tension strength $\sigma_{Rk,s,fi}$ [N/mm ²] of an unprotected fastener made of stainless steel of at least steel grade A4 according to the EN ISO 3506 series in case of fire exposure			
		30 min (R15 to R30)	60 min (R45 to R60)	90 min (R90)	120 min (\leq R120)
Ø6	≥ 30	10	9	7	5
Ø8	≥ 30	20	16	12	10
Ø10	≥ 40	25	20	16	14
Ø12 and greater	≥ 50	30	25	20	16

Table D.2 - Characteristic tension strength of a stainless steel fastener under fire exposure

Concrete cone failure

The characteristic resistance of a single fastener not influenced by neighbouring fasteners (anchors) or concrete edges installed in concrete strength classes C20/25 to C50/60 may be obtained according to:

$N_{Rk,c,fi(90)}^0 = \frac{h_{ef}}{200} \cdot N_{Rk,c}^0 \leq N_{Rk,c}^0$	for fire exposure up to 90 min
$N_{Rk,c,fi(120)}^0 = 0,8 \frac{h_{ef}}{200} \cdot N_{Rk,c}^0 \leq N_{Rk,c}^0$	for fire exposure between 90 min and 120 min

h_{ef} is the effective embedment depth

$N_{Rk,c}^0$ is the characteristic resistance of a single fastener in cracked concrete C20/25 under ambient temperature according to static loads. The characteristic spacing $s_{cr,N}$ and edge distance $c_{cr,N}$ should be taken as follows: $s_{cr,N} = 2 c_{cr,N} = 4 h_{ef}$ (headed and post-installed fasteners)

Pull-out failure

The characteristic resistance of headed and post-installed mechanical fasteners installed in concrete classes C20/25 to C50/60 may be obtained from:

$N_{Rk,p,fi(90)} = 0,25 \cdot N_{Rk,p}$	for fire exposure up to 90 minutes
$N_{Rk,p,fi(120)} = 0,20 \cdot N_{Rk,p}$	for fire exposure between 90 minutes and 120 minutes

$N_{Rk,p}$ is the characteristic resistance for pull-out failure given in the relevant European Technical Product Specification in cracked concrete C20/25 under ambient temperature

Splitting failure

The assessment of concrete splitting failure due to fire exposure is not required because the splitting forces are assumed to be taken up by the reinforcement.

REQUIRED VERIFICATION FOR FASTENERS IN SHEAR

Steel failure without lever arm

For the characteristic shear strength $\tau_{Rk,s,fi}$ of a fastener in the case of shear load without lever arm and steel failure under fire exposure the values given in Tables D.1 and D.2 for the characteristic tension strength may be used ($\tau_{Rk,s,fi} = \sigma_{Rk,s,fi}$). These values apply for the unprotected steel part of the fastener outside the concrete and may be used in the design. The characteristic resistance $V_{Rk,s,fi}$ is obtained as follows:

$$V_{Rk,s,fi} = A_s \cdot \sigma_{Rk,s,fi}$$

NOTE

Limited numbers of tests have indicated, that the ratio of shear strength to tensile strength increases under fire conditions above that for normal ambient temperature design. Here it is assumed that this ratio is equal to 1,0. This is a discrepancy to the behaviour in the cold state where the ratio is smaller than 1.

Steel failure with lever arm

The characteristic shear resistance of a single fastener in case of shear load with lever arm under fire exposure, $M_{0Rk,s,fi}$ should be obtained from Formula

$$M_{Rk,s,fi} = 1,2 \cdot W_{el} \cdot \sigma_{Rk,s,fi}$$

Concrete pry-out failure

The characteristic resistance in case of fasteners installed in concrete classes C20/25 to C50/60 should be obtained using Formula:

$V_{Rk,cp,fi(90)} = k_b \cdot N_{Rk,c,fi(90)}$	for fire exposure up to 90 minutes
$V_{Rk,cp,fi(120)} = k_b \cdot N_{Rk,c,fi(120)}$	for fire exposure between 90 minutes and 120 minutes

k_b is the factor to be taken from the relevant European Technical Product Specification (ambient temperature)

Concrete edge failure

The characteristic resistance of a single fastener installed in concrete classes C20/25 to C50/60 should be obtained using Formula:

$V_{Rk,c,fi(90)} = 0,25 \cdot V_{0Rk,c}$	for fire exposure up to 90 minutes
$V_{Rk,c,fi(120)} = 0,20 \cdot V_{0Rk,c}$	for fire exposure between 90 minutes and 120 minutes

$V_{0Rk,c}$ is the initial value of the characteristic resistance of a single fastener in cracked concrete C20/25 under normal ambient temperature.

REQUIRED VERIFICATION FOR FASTENERS IN TENSION

	Failure mode	Verification
1	Steel failure of fastener ^a	$\left(\frac{N_{Ed}}{N_{Rd,s}}\right)^2 + \left(\frac{V_{Ed}}{V_{Rd,s}}\right)^2 \leq 1$ and $N_{Ed}/N_{Rd,s} \leq 1$ and $V_{Ed}/V_{Rd,s} \leq 1$
2	Failure modes other than steel failure	$\left(\frac{N_{Ed}}{N_{Rd,i}}\right)^{1,5} + \left(\frac{V_{Ed}}{V_{Rd,i}}\right)^{1,5} \leq 1$ or $\left(\frac{N_{Ed}}{N_{Rd,i}}\right) + \left(\frac{V_{Ed}}{V_{Rd,i}}\right) \leq 1,2$ and $N_{Ed}/N_{Rd,i} \leq 1$ and $V_{Ed}/V_{Rd,i} \leq 1$

^a This verification is not required in case of shear load with lever arm



SEISMIC DESIGN

When it is appropriate to consider dynamic actions as quasi-static, the dynamic parts may be considered either by including them in the static values or by applying equivalent dynamic amplification factors to the static actions.

The seismic performance of fasteners subjected to seismic loading is categorized by performance categories C1 and C2. Performance category C1 provides fastener capacities only in terms of resistances at ultimate limit state, while performance category C2 provides fastener capacities in terms of both

resistances at ultimate limit state and displacements at damage limitation state and ultimate limit state. The requirements for category C2 are more stringent compared to those for category C1. The performance category valid for a fastener is given in the corresponding European Technical Product Specification.

Table C.1 relates the seismic performance categories C1 and C2 to the seismicity level and building importance class. The level of seismicity is defined as a function of the product $a_g \cdot S$, where a_g is the design ground acceleration on Type A ground and S the soil factor both in accordance with EN 1998-1.

Seismicity level ^a		Importance Class acc. to EN 1998-1:2004, 4.2.5			
Class	$a_g \cdot S^c$	I	II	III	IV
Very Low ^b	$a_g \cdot S \leq 0,05g$	No seismic performance category required			
Low ^b	$0,05g \leq a_g \cdot S \leq 0,1g$	C1	C1 ^d or C2 ^e		C2
> low	$a_g \cdot S > 0,1g$	C1	C2		

Table C.1 Recommended seismic performance categories for fasteners

^a The values defining the seismicity levels are subject to a National Annex. The recommended values are given here.

^b Definition according to EN 1998-1:2004, 3.2.1.

^c a_g = design ground acceleration on type A ground (see EN 1998-1:2004, 3.2.1),

S = soil factor (see EN 1998-1:2004, 3.2.2).

^d C1 for fixing non-structural elements to structures (Type ,B' connections).

^e C2 for fixing structural elements to structures (Type ,A' connections).

NOTE

The recommended seismic performance categories are given in Table C.1. The value of a_g or that of the product $a_g \cdot S$ used in a Country to define threshold values for the seismicity classes may be found in its National Annex of EN 1998-1.

Furthermore the assignment of the seismic performance categories C1 and C2 to the seismicity level and building importance classes in a Country may be found in its National Annex to this EN.

Importance class	Buildings
I	Buildings of minor importance for public safety, e.g. agricultural buildings, etc.
II	Ordinary buildings, not belonging in the other categories.
III	Buildings whose seismic resistance is of importance in view of the consequences associated with a collapse, e.g. schools, assembly halls, cultural institutions etc.
IV	Buildings whose integrity during earthquakes is of vital importance for civil protection, e.g. hospitals, fire stations, power plants, etc.

Table 4.3 Importance classes for buildings

In the design of fastenings one of the following options a1), a2) or b) shall be satisfied.

- a) Design without requirements on the ductility of the fasteners. It shall be assumed that fasteners are non-dissipative elements and they are not able to dissipate energy by means of ductile hysteretic behaviour and that they do not contribute to the overall ductile behaviour of the structure.
- a1) Capacity design: The fastener or group of fasteners is designed for the maximum tension and/or shear load that can be transmitted to the fastening based on either the development of a ductile yield mechanism in the fixture or the attached element taking into account strain hardening and material over-strength or the capacity of a non-yielding attached element.
- a2) Elastic design: The fastening is designed for the maximum load obtained from the design load combinations that include seismic actions EEd corresponding to the ultimate limit state (see EN 1998-1) assuming elastic behaviour of the fastening and the structure. Furthermore, uncertainties in the model to derive seismic actions on the fastening shall be taken into account.
- b) Design with requirements on the ductility of the fasteners: This option is applicable only for the tension component of the load acting on the fastener. The fastener or group of fasteners is designed for the design actions including the seismic actions EEd corresponding to the ultimate limit state (see EN 1998-1). The tension steel capacity of the fastening shall be smaller than the tension capacity governed by concrete related failure modes. Sufficient elongation capacity of the fasteners is required. The fasteners should not be accounted for energy dissipation in the global structural analysis or in the analysis of a non-structural element. The contribution of the fastening to the energy dissipation capacity of the structure (see EN 1998-1:2004, 4.2.2) is not addressed within this standard. Option b) should not be used for the fastening of primary seismic members (see EN 1998-1) due to the possible large non-recoverable displacements of the fastener that may be expected. Unless shear loads acting on the fastening are resisted by additional means, additional fasteners should be provided and designed in accordance with option a1) or a2).

REQUIRED VERIFICATION FOR FASTENERS

Generally the seismic design resistance of a fastening is given by:

$$N_{Ed} \leq N_{Rd,eq} = \frac{N_{Rk,eq}}{V_{M,eq}}$$

$V_{M,eq}$ the recommended values for the partial factors for fastenings under seismic loading are identical to the corresponding values for quasi static loading.

$N_{Rk,eq}$ the characteristic seismic resistance of a fastening

$$N_{Rk,eq} = \alpha_{gap} \cdot \alpha_{eq} \cdot N_{Rk,eq}^0$$

α_{gap} is the reduction factor to take into account inertia effects due to an annular gap between fastener and fixture in case of shear loading, given in the relevant European Technical Product Specification

α_{eq} is the factor to take into account the influence of seismic actions and associated cracking on a) concrete cone resistance and bond strength of supplementary reinforcement, and b) resistance of groups due to uneven load transfer to the individual fasteners in a group

$N_{Rk,eq}^0$ is the basic characteristic seismic resistance for a given failure mode. For steel and pull-out failure under tension load and steel failure under shear load $N_{Rk,eq}$ shall be taken from the relevant European Technical Product Specification (i.e. $N_{Rk,s,eq}$, $N_{Rk,p,eq}$, $V_{Rk,s,eq}$).

Loading	Failure mode	Single fastener ^a	Fastener group
tension	Steel failure	1,0	1,0
	Concrete cone failure - Headed fastener and undercut fasteners with k_1 – factor same as headed fastener - all other fasteners	1,0 0,85	0,85 0,75
	Pull-out failure	1,0	0,85
	Combined pull-out and concrete failure (bonded fastener)	1,0	0,85
shear	Concrete splitting failure	1,0	0,85
	Steel failure	1,0	0,85
	Concrete pry-out failure - Headed fastener and undercut fasteners with k_1 – factor same as headed fastener - all other fasteners	1,0 0,85	0,85 0,75
	Concrete edge failure	1,0	0,85

^a This also applies where only one fastener in a group is subjected to tension load.

Table C.3 Reduction factor α_{eq}

COMBINED TENSION AND SHEAR LOADS

	Failure mode	Verification
1	Steel failure of fastener ^a	$\left(\frac{N_{Ed}}{N_{Rd,s,eq}}\right) + \left(\frac{V_{Ed}}{V_{Rd,s,eq}}\right) \leq 1$ and $N_{Ed}/N_{Rd,s,eq} \leq 1$ and $V_{Ed}/V_{Rd,s,eq} \leq 1$
2	Failure modes other than steel failure	$\left(\frac{N_{Ed}}{N_{Rd,t,eq}}\right)^{k_{15}} + \left(\frac{V_{Ed}}{V_{Rd,t,eq}}\right)^{k_{15}} \leq 1$ and $N_{Ed}/N_{Rd,t,eq} \leq 1$ and $V_{Ed}/V_{Rd,t,eq} \leq 1$

^a This verification is not required in case of shear load with lever arm

$k_{15} = 2/3$ for fastenings with a supplementary reinforcement to take up tension or shear loads only = 1 in all other cases



ANCHORS – MODULE CONCRETE - MANUAL

General information

1 Select a category and module

Designation of icons and symbols :

- Create a new project
- Open project
- Save | Save as project
- Undo | Redo changes
- Generate printout to pdf file
- Program information
- Selecting the program language
- User Manual

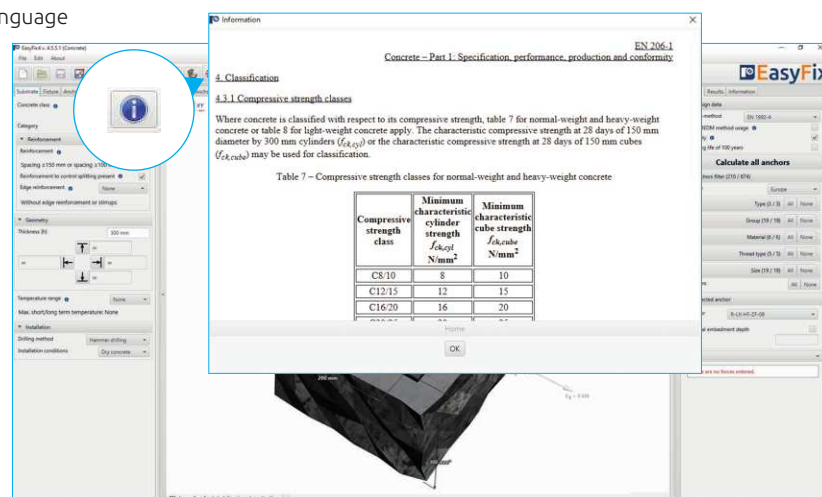
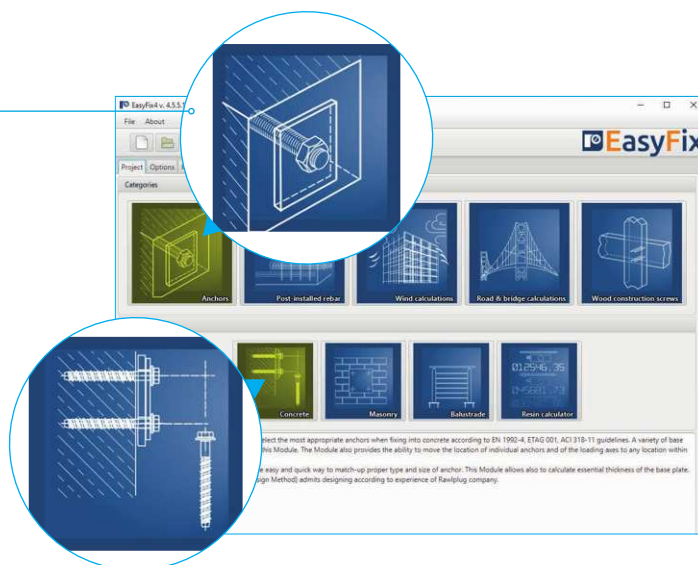

DESIGN SOFTWARE - CONCRETE MODULE



ANCHORS – MODULE CONCRETE - MANUAL

2 Introduction
Basic window of the Concrete module

It is separated into three areas:

1. data entry
2. model view
3. results with filters

1. Input area

- Substrate
- Base
- Anchors
- Loads
- View

2. Model view

- 3D view with rotation and zoom in/out

3. Results area

- Anchor - filter products
- Results - for a selected product
- Product information

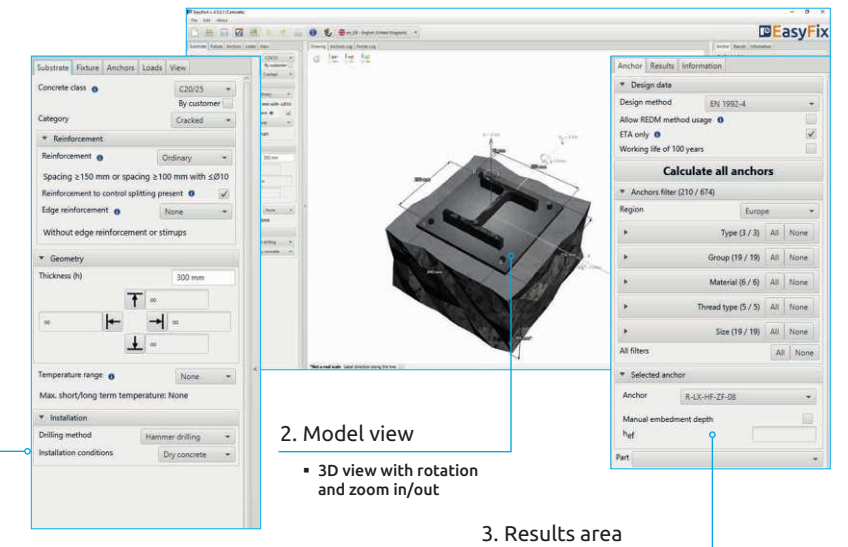

3 Substrate tab
Data input area

Determine concrete class (also by user and select cracked/un-cracked concrete)

Definition of reinforcement or lack thereof in the structure

Definition dimensions and edges of concrete

Definition of the temperature range and the installation method and conditions determines the filtering range of the anchors

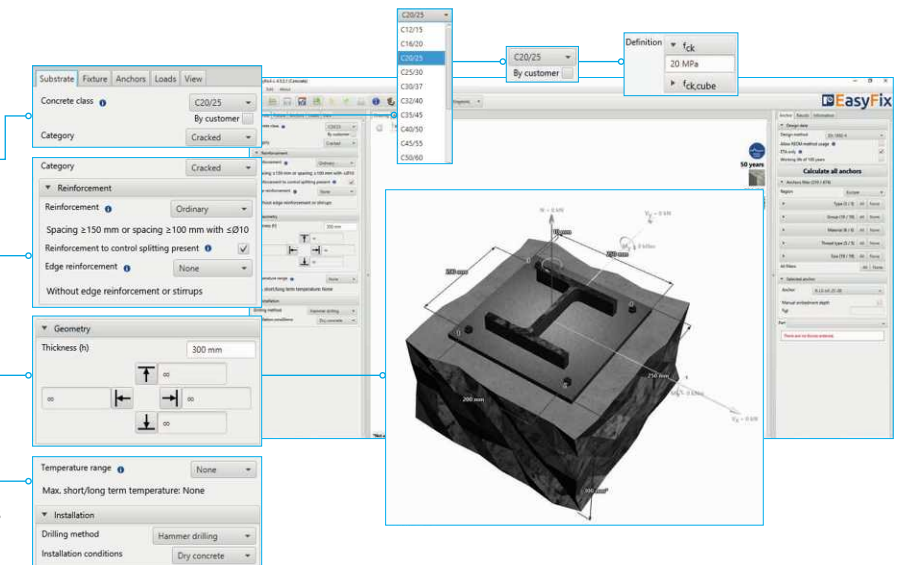

4 Fixture tab
Input area

Specify the Material and Shape of the fixture from the shape palette and specify the dimensions or according to the customer. Calculate Thickness button opens an auxiliary window for calculating the base plate thickness (calculation possible after introducing the load) Button Shape allows you to select the type and size of the shape, also the own shape according to the user

Choosing an asymmetrical placement allows you to shift the force application point relative to the base's center of gravity

Selecting Lever arm allows you to calculate the forces on the arm due to the distance between the base plate and the ground

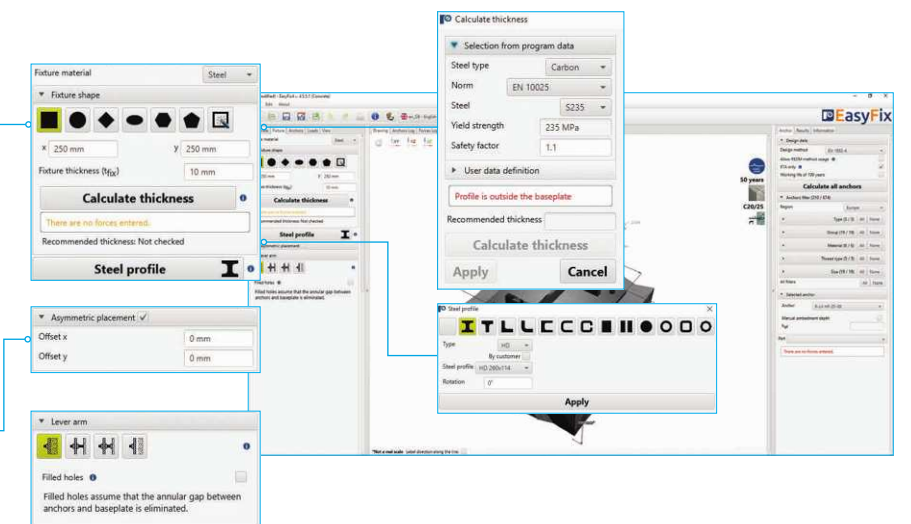

ANCHORS – MODULE CONCRETE - MANUAL

4 Fixture tab
Input area

Selecting the Any Base Shape icon activates the Base Shape button which opens an additional window for drawing any shape. The shape is drawn using the mouse or by entering the coordinates into the auxiliary window

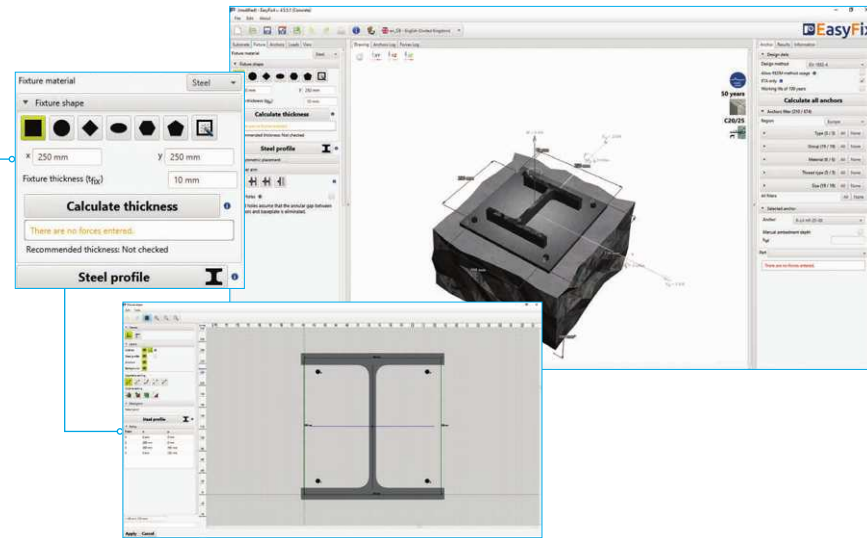

5 Anchors tab
Input area

Allows selection of anchor layout from pre defined layouts or by user using from a group of n-anchors

Dimensions
distances between anchors can be entered in the tab or directly on the model by clicking on the dimension line

Declaring elongated "bean" holes changes the distribution of shear forces on the anchors

Determination of the offset of the anchor system from the centre of gravity of the base plate

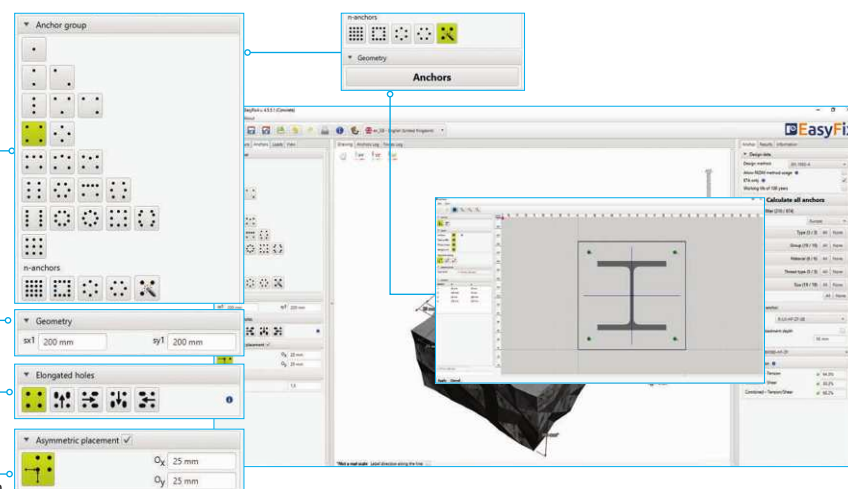

6 Loads tab
Input area

The introduction of fire and seismic loads affects the filtering range of the anchors. The suffix SUS applies to long-term loads for screw in anchors according to EN 1992 4 results with filters

Static loads
calculated or characteristic, with user defined safety factors

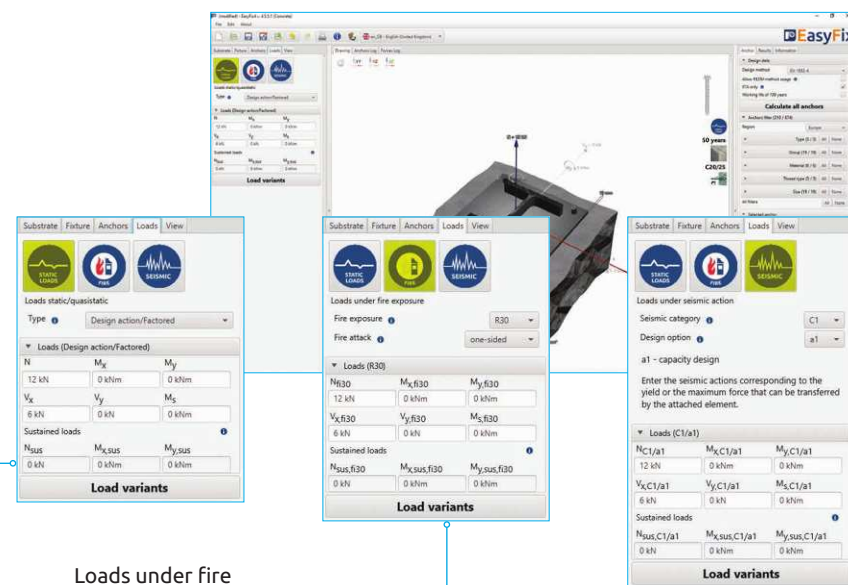

Loads under fire
for different fire resistances

Seismic loads
for seismic resistance C1 and C2

ANCHORS – MODULE CONCRETE - MANUAL

6 Loads tab
Input area

Load Variants
allows you to calculate load variants for a structure. It is possible to import load variants from Robot (csv, xls)

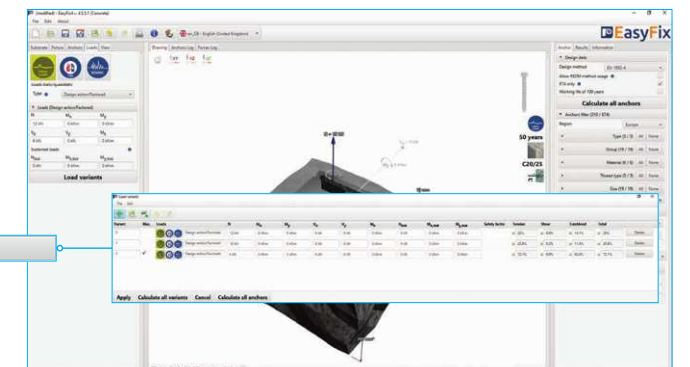

7 Model tab
Model view with data input

View
Clicking on a dimension line or force vector allows you to enter data directly into the drawing

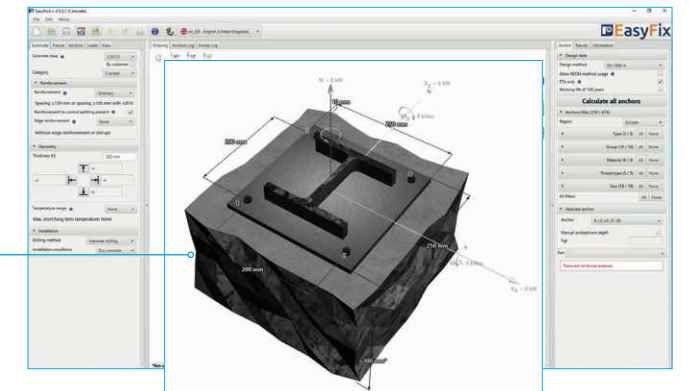

8 Anchor tab
Result area

REDM - Rawplug Engineering Design Method is a method which allows for the calculation of anchor systems not covered by EN and ETAG methods. By checking the box **Only ETA** data it is possible to use test data from Rawplug

Design method
enables selection of the calculation method and the program database

Filters
allow selection of anchors by design region, and type and material of construction

Selected anchors
makes it possible to specify the choice of anchor, to impose the depth of anchorage

Utilisation
summary results window for the selected anchor

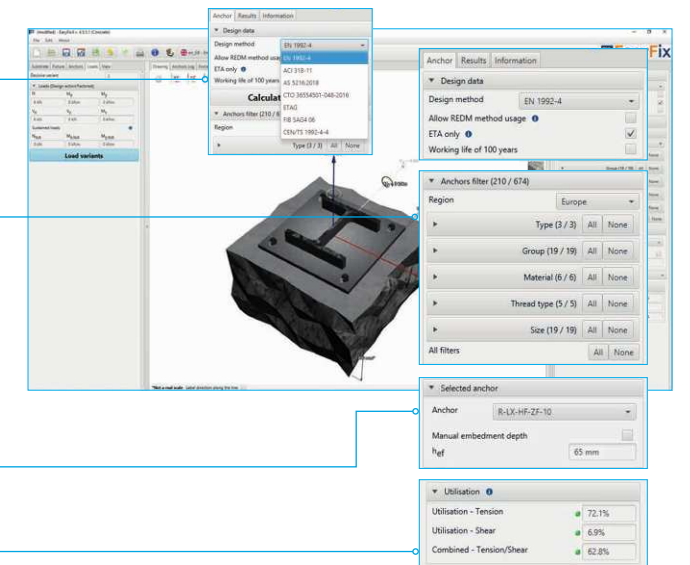

9 Anchor tab
Result area

Calculate all anchors
calculation of all anchors for a given load

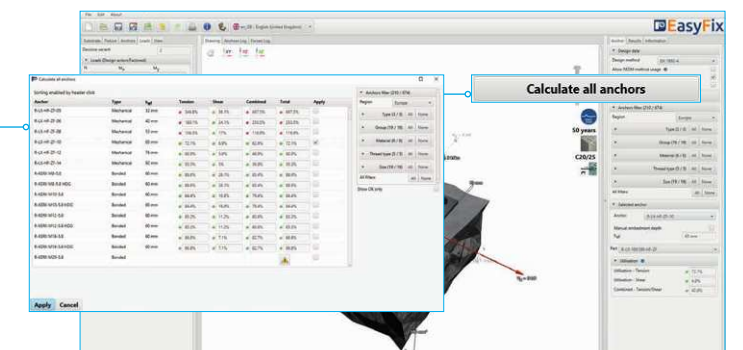

10 Anchor tab Result area

Resulting forces in anchors

gives values for pull out and shear forces acting on individual anchors

Tensile loads

percentage strain of the anchor system from tensile forces in individual failure images

Shear loads

percentage stress of the anchor system from shear forces in individual failure images

Combined action

shear and tensile interaction percentage of steel and concrete stresses

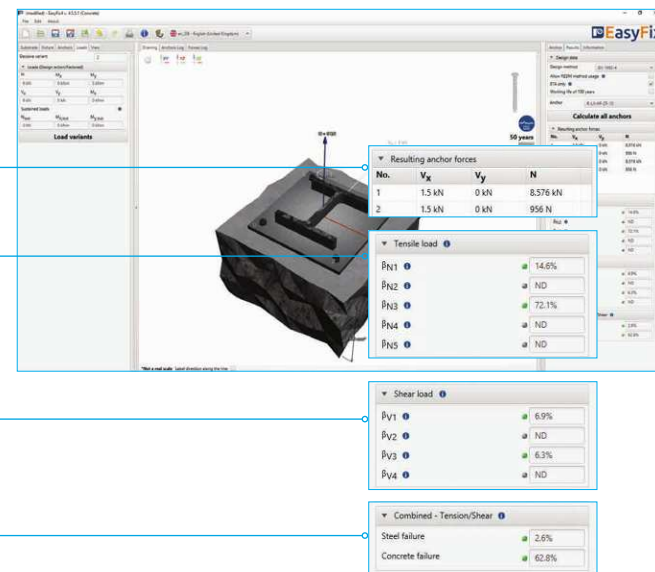

11 Anchor tab Result area

Installation data

installation parameters for the designed anchor

Links to:

Technical Library
BIM Library
RTH Technical Help

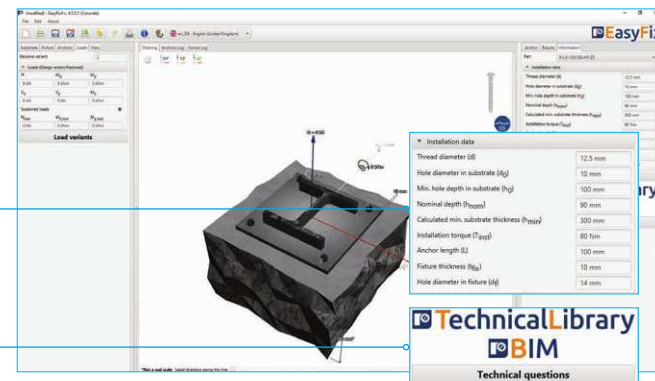

12 Generation of Printout

Assembly data

parameters Print option enables generation of a document in pdf extension

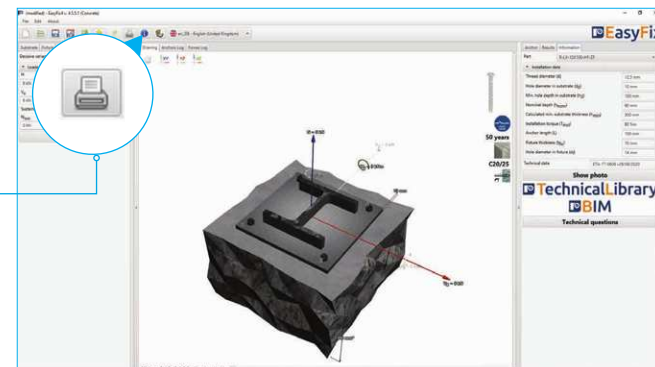

THE BASE MATERIAL/SUBSTRATE

Consideration of the base material (and its associated properties) is critical in the selection of an anchor or connector technology. It is therefore important to correctly define the material in order to ensure correct anchor installation without substrate damage, as well as safe and reliable subsequent performance under load.



Concrete
Concrete, in its standard form, is a compound of cement, aggregates and water. It usually possesses high compressive strength, while tensile strength is comparatively low.



Lightweight concrete is another derivative, in which case heavy aggregate is replaced by light additives like pumice, slag or Styrofoam. Due to the lower compressive strength of these materials, lightweight concrete shows lower strength parameters in general when compared to plain concrete.

(according to ENV 206 standard). In this format, the values before and after the oblique signify characteristic compressive strengths measured for cylinders (150mm diameter, 300mm height) and cubes (150mm edge), respectively. The table below lists concrete compressive strengths traditionally applied in different countries.

As a measure to increase the low tensile strength of concrete, steel reinforcing elements (bars, mesh, etc.) may be cast into the concrete member. Their function is to withstand tensile loads within the structure, which may otherwise lead to extensive crack formation within the tensile zone. Reinforcement does not guarantee elimination of cracking in this so-called crack zone. It does, however, limit the size of cracks significantly, ultimately leading to an admissible crack size of no greater than 0.3 mm. Cracks usually assume a wedge form, terminating in the region of the neutral axis within the concrete structure cross-section.

Products approved for use in cracked concrete

R-HPTII-A4, R-HPTII-ZF, R-SPLII, R-DCA, R-DCL, R-RBL, R-RBP, R-KER, R-KEX II

This document presents anchor performance data for the following concrete grades: C20/25, C30/37, C40/50 and C50/60

Grade CE	Characteristic compressive strength F_{ck} (cylinder)	Characteristic compressive strength F_{ck} (cube)	Great Britain	Germany	France	Poland
			Mean compressive strength, tested (150mm cube)	Mean compressive strength, tested (200mm cube)	Mean resistance, tested (cylinder 16x32cm)	PN-B-03264:2002
C12/15	12	15	20	19	17	B15
C16/20	16	20	25	24	21	B20
C20/25	20	25	30	29	25	B25
C25/30	25	30	35	33	30	B30
C30/37	30	37	42	40	35	B37
C35/45	35	45	50	48	40	B45
C40/50	40	50	55	54	45	B50
C45/55	45	55	60	57	50	B55
C50/60	50	60	65	62	55	B60

MASONRY

Masonry walls are multi-layer substrates consisting of blocks of heterogeneous material, built in to the desired structure using mortar.

The compressive strength of the block material is usually higher than that of the mortar. Thus the connectors should, as a rule, be installed within the body of the block.

Blocks may take several forms:

» Solid blocks with compact structure. Blocks of various dimensions, without internal cavities, made from ceramic (ceramic or clinker bricks) or sand-lime (silica) materials. These possess relatively high compressive strength.

» Hollow blocks with compact structure. Blocks of various dimensions and shapes, with several internal cavities. Blocks possess reasonably low compressive strength, despite being made from relatively high compressive strength materials (ceramic or silica).

» Solid blocks with porous structure. Blocks of various dimensions, without internal cavities but with high concentrations of pores or inclusions of other materials. Examples include aerated concrete or solid blocks of lightweight concrete. Materials of this category possess low compressive strengths.

» Hollow blocks with porous structure. Similarly to solid porous blocks these elements have low compressive strength, weakened further by internal cavities. In most cases these blocks are made from lightweight concrete.

Products with Approval for masonry and hollow walls:
R-KEM II and RM50



solid brick (ceramic or silica) lightweight concrete hollow brick hollow block



EasyFix
MASONRY Module

DESIGN SOFTWARE - MASONRY MODULE



2 Introduction

Basic window of the Facade module

The basic window is divided into three areas:

1. Input area
2. Model view
3. Results

1. Input area

- Substrate
- Fixture
- Anchors
- Loads

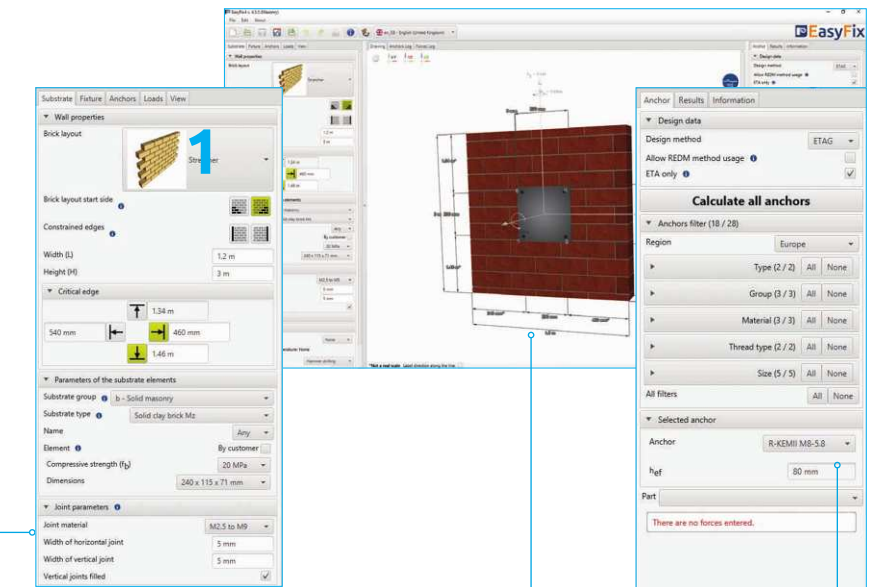

2. Model view

- 3D view with rotation and zoom in/out

3. Results

- Anchor - Filter products
- Results - for a selected product
- Product information

DESIGN SOFTWARE - MASONRY MODULE



MASONRY MODULES - MANUAL

General information

1 Select a category and module

Designation of icons and symbols:

- Create a new project
- Open project
- Save | Save as project
- Undo | Redo changes
- Generate printout to pdf file
- Program information
- Selecting the program language
- User Manual

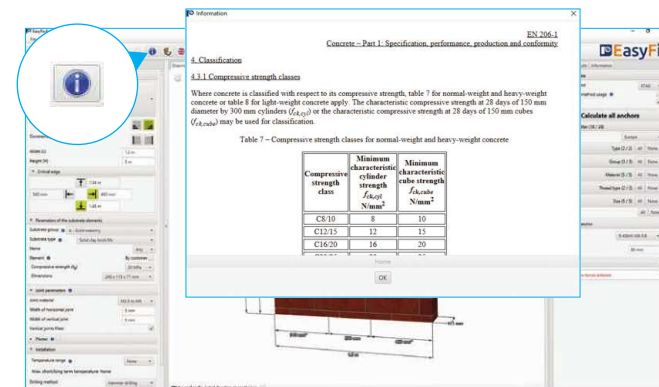
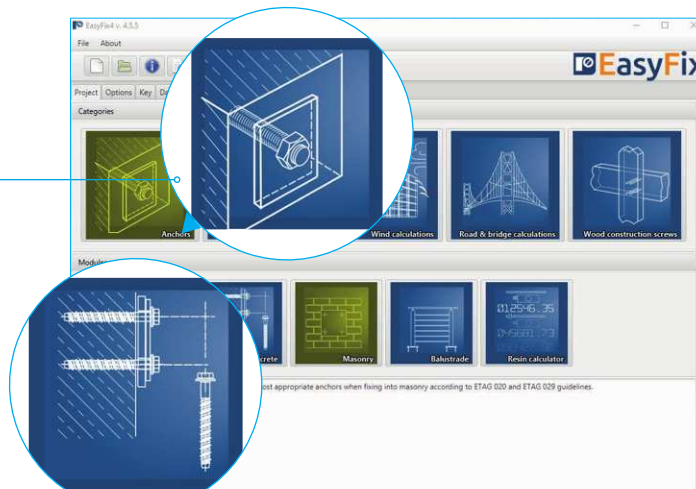

ANCHORS - MODULE CONCRETE - MANUAL

3 Substrate tab

Data input area

Wall properties

- Brick layout - pull-down list
- Brick start side - left or right
- Constrained edges
- Dimensions

Critical Edge

distances from edges wall

Parameters of the substrate elements

selected from pull-down list or by customer

Joint parameters

- Class and dimensions
- Vertical joints filled or not

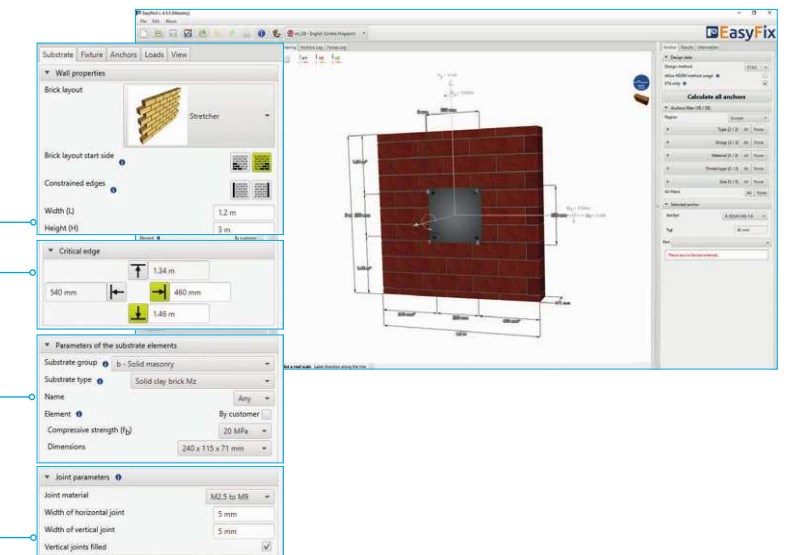

4 Fixture tab

Input area

Specify the Material and Shape

of the fixture from the shape palette and the dimensions
Rolled section allows you to select the type and size of the shape

Choosing an asymmetrical placement

allows you to shift the force application point relative to the base's center of gravity

Selecting Lever arm

allows you to calculate the forces on the arm due to the distance between the base plate and the ground

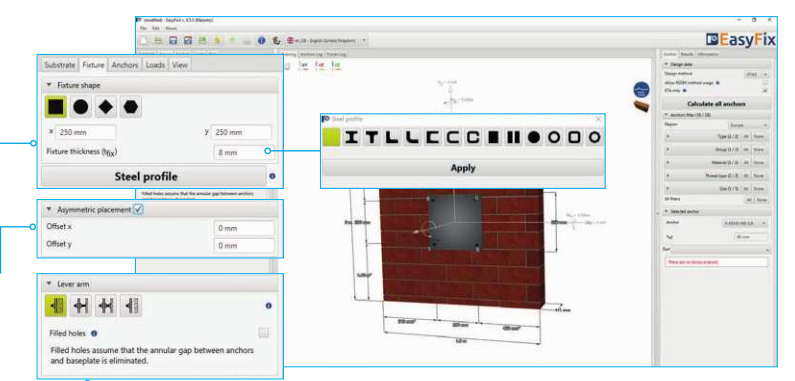

ANCHORS - MODULE CONCRETE - MANUAL

5 Fixture tab
Input area

Allows selection of anchor layout from pre-defined layouts

Geometry

distances between anchors can be entered in the tab or directly on the model by clicking on the dimension line

Declaring elongated "bean" holes

changes the distribution of shear forces on the anchors

Asymmetric placement

determination of the offset of the anchor system from the centre of gravity of the base plate

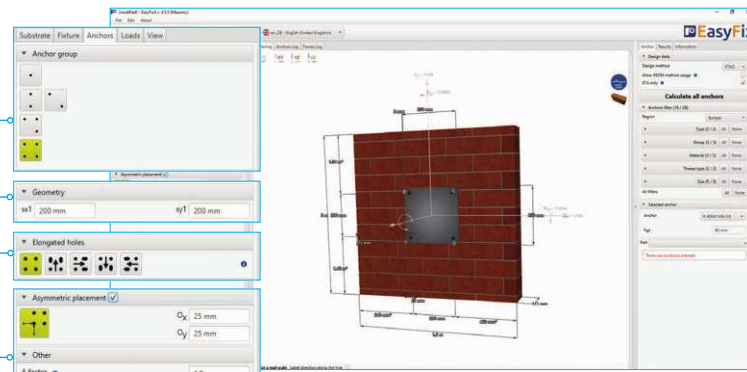

6 Fixture tab
Input area

The introduction of fire and seismic loads affects the filtering range of the anchors. The suffix SUS applies to long-term loads for screw-in anchors according to EN 1992-4

Static loads

calculated or characteristic, with user-defined safety factors

Load Variants

allows you to calculate load variants for a structure. It is possible to import load variants from Robot (csv, xls)

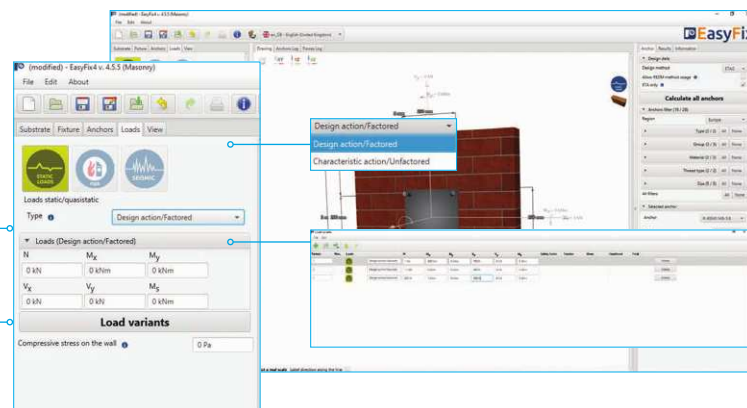

7 Fixture tab
Input area

View

Clicking on a dimension line or force vector allows you to enter data directly into the drawing

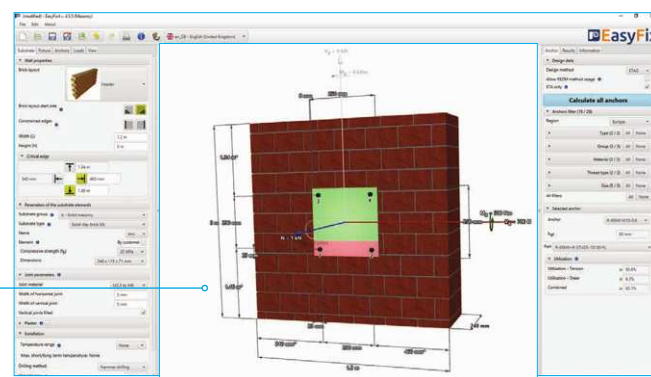

8 Anchors tab
Input area

By checking the box **ETA only** data it is possible to use test data from Rawlplug

Design data

enables selection of the calculation method and the program database

Filters

allow selection of anchors by design region, and type and material of construction

Selected anchors

makes it possible to specify the choice of anchor, to impose the depth of anchorage

Utilisation

summary results window for the selected anchor

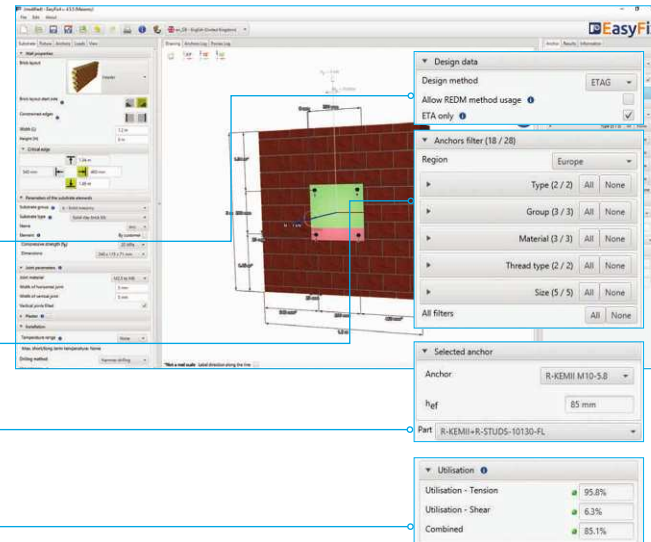

ANCHORS - MODULE CONCRETE - MANUAL

9 Anchors tab
Result area

Calculate all anchors
calculation of all anchors for a given load

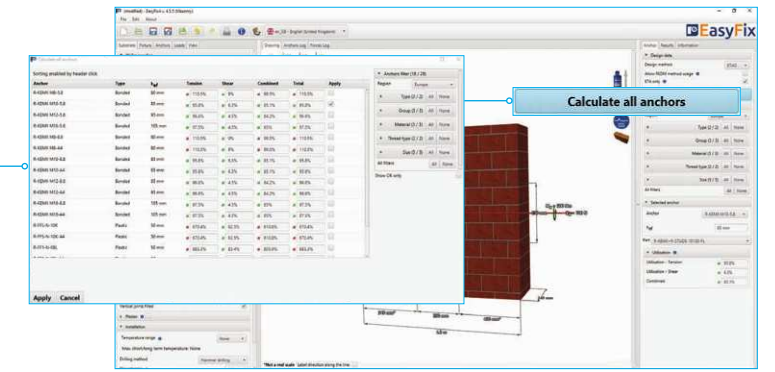

9 Anchors tab
Result area

Resulting forces in

anchors - gives values for pull-out and shear forces acting on individual anchors

Tensile loads

percentage strain of the anchor system from tensile forces in individual failure images

Shear loads

percentage stress of the anchor system from shear forces in individual failure images

Combined action

shear and tensile interaction

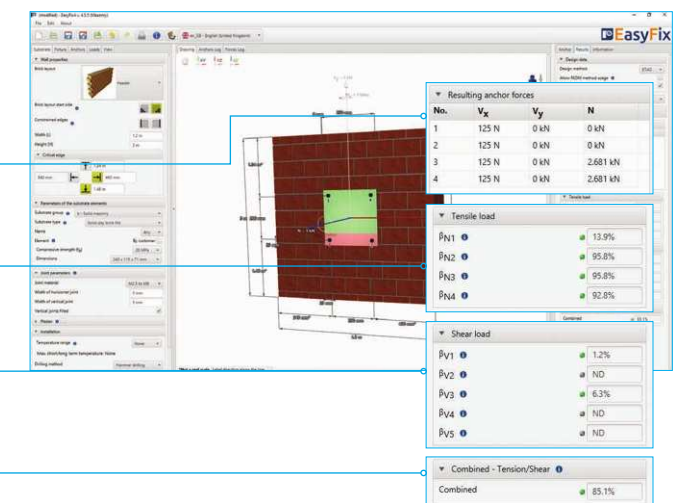

11 Anchor tab
Information area

Installation data

installation parameters for the designed anchor

Links to:

- Technical Library
- BIM Library
- RTH Technical Help

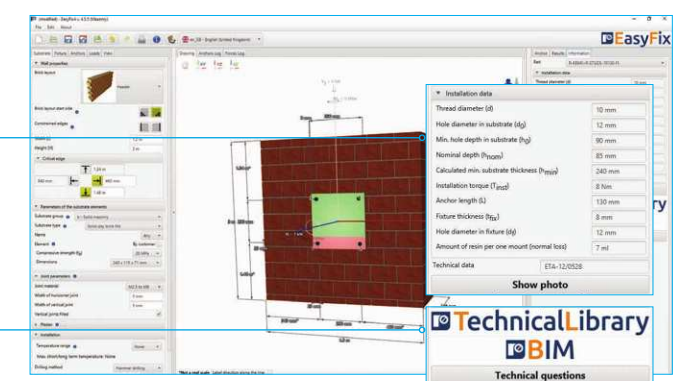

12 Fixture tab
Input area

Print option

enables generation of a calculation report in pdf extension

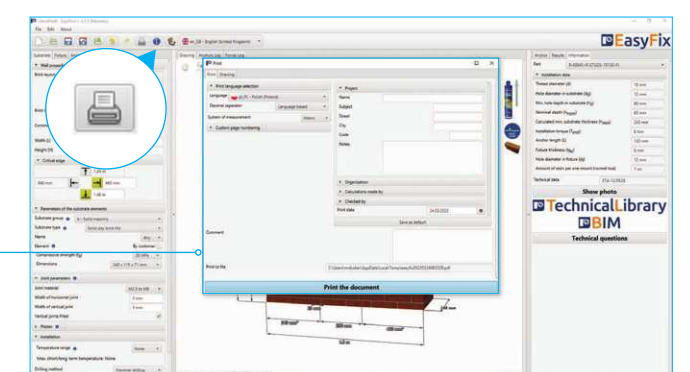

BASICS OF ANCHORING - MATERIALS

ANCHOR MATERIAL

Steel

Durability characteristics of screws and bolts are determined by appropriate mechanical property classes from 3.6 to 12.9. This classification system consists of two numbers separated with a dot, e.g.

5.6

The first number corresponds to the value of 0.01 R_m of the finished part in MPa. The second number determines the value of 0.1 of R_e/R_m percentage ratio, as follows:

$$R_m = 500 \text{ MPa} \quad | \quad R_e/R_m = 60\% \quad | \quad R_g = 300 \text{ MPa}$$

The strength classes of nuts are marked 4, 5, 6, 7, 8, 10 & 12 which corresponds with the value of 0.01 of R_m of nut steel in MPa.



Nut classes shall correspond to screw or bolt classes; therefore, for class 5.6 screws or bolts, class 5 (or greater) nuts shall be used.

ANCHOR SPACING AND EDGE DISTANCES

Due to the expansion forces induced by the functioning of anchorage connections, the following parameters shall be taken into account while determining load bearing capacity for a particular product:

- » thickness of base material (determined by fixing's effective embedment depth h_{ef})
- » spacing of anchored joints (s)

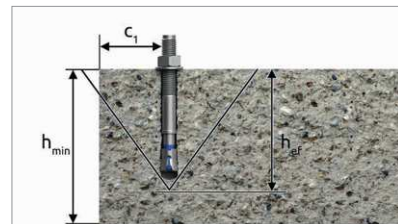
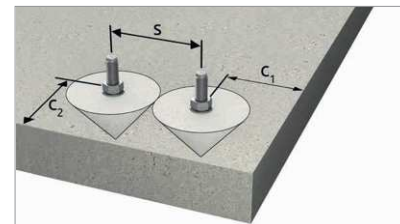

- » distance of connections from the edge (c₁, c₂) and corners (c₃) of the base material.

Overlapping of tension cones of neighbouring anchorages in concrete reduces the load bearing capacity of such fasteners.

BASICS OF ANCHORING - SPACING & EDGE DISTANCES

Reduction of anchor spacing and edge distances

In some cases the anchor spacing and distance from edges and corners can be reduced. Such a reduction will impact the anchor's load bearing capacity and, in order to account for the impact, one or more reduction factors will have to be applied.

Effective embedment of fixing h_{ef}

For each connection the minimum fixing depth is determined, which ensures safe load resistance. Some types of anchors can be fixed at greater depth, which increases the load bearing capacity (R-SPL, in particular). For more information, please contact RAWLPLUG® technical consultant.

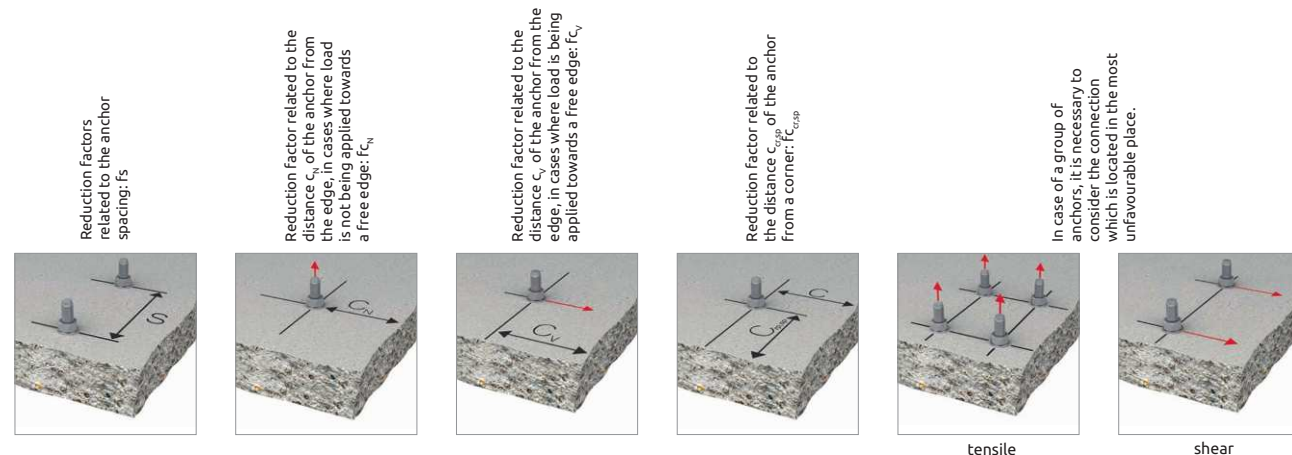

REDUCED DESIGN RESISTANCE OF ANCHOR

$$F_{Rd,rec} = F_{Rd} \cdot f_s \cdot f_{cN} \cdot f_{cV}$$

$$F_{Rd,red} \geq F_{Sd}$$

F_{Rd} – design resistance according to the technical data tables herein, f_s, f_{cN}, f_{cV} – reduction factors of axial spacing of anchors and distance to the edge of the base material.

BASICS OF ANCHORING - ANCHOR INSTALLATION

DRILLING

The method of drilling a hole for the installation of an anchor depends on the type of substrate material. There are drilling techniques:

- » rotary drilling – drilling by rotation and without percussion (or hammer action), recommended for drilling in materials of low mechanical strength such as bricks & aerated concrete due to the fact that it does not enlarge the hole, nor damage the structure of the material;
- » percussive drilling – drilling by rotation with multiple light strikes with the drill bit into the substrate; recommended for drilling materials with high mechanical strength and solid structure such as concrete & solid brick;
- » hammer drilling – drilling by rotation with a small number of high energy strikes with the drill bit into the substrate; recommended for drilling in extremely hard structures such as concrete;

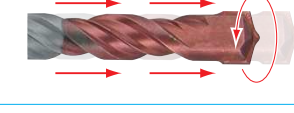
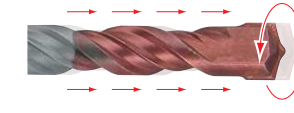

A drill bit is a tool, which is subject to wear – its degree and frequency is a derivative of the hardness of the substrate material. The harder the substrate, the greater the wear of the drill bit. Be sure to monitor wear and replace the drill bit whenever necessary.

In the process of drilling a hole for embedding an anchor it is important to be aware of and achieve the correct diameter and depth of the hole.

After the drilling is finished it is essential to clear the hole of dust and drill debris. Failure to do this can be the cause of improper anchoring of the fastener in the substrate.

ANCHOR INSTALLATION METHODS

1. Push-through installation – convenient and time-efficient method, which allows user to drill and install directly through the fixture without marking out hole locations and pre-positioning anchors. If the fixture is pre-drilled then it may be used as a drilling template, before the anchors are installed directly through the clearance holes. RAWLPLUG® R-XPT, R-XPTII and R-HPTII throughbolt families are all examples of push-through fixings.
2. Pre-positioning installation – this method requires the installation of the anchors in the base material, before the fixture is moved into place. In this case the anchor diameter and the

drill hole diameter are different. Our RAWLBOLT (R-RBP) and all bonded anchors are examples of products that require pre-positioning.

3. Stand-off installation – attachment of the fixture at an offset distance from the surface of the base material. One common offset application is the use of internally threaded anchors with long rods, studs or bolts. The anchor is installed in the base material before assembling with threaded rod or bolt. The RAWLPLUG® internally threaded wedge anchors - R-DCA, R-DCA-A4 & R-DCL - may be used for stand-off applications.

BASICS OF ANCHORING - TORQUE & BENDING MOMENTS

TIGHTENING TORQUE

When using expanding anchors, it is necessary to apply a required tightening torque of the magnitude given herein, in order to ensure optimal expansion and achieve the load-bearing capacities given in tables in the next chapter (we recommend using a calibrated torque wrench). Torque transmits to a pre-tensioning force, influencing the initial expansion of the anchor. Moreover, the tightening torque applied will clamp the fixed element to the base material.

The values of tightening torque given in the specification and design guide should not be exceeded.

After initial application of the tightening torque, relaxation occurs causing a reduction in tension and therefore clamping force.

All data related to a load bearing capacity given in the present specification and design guide account for this torque relaxation behaviour.

BENDING MOMENT

In the case of some applications, anchored connections are subject to the influence of bending moments. Generally, this applies when fixed elements are offset from the base material. Applied load is, as a result, not purely in the shear direction - significant tension is also present. It is necessary to ensure the bending moment induced by such loads is not higher than allowable bending moment (given for each type and diameter of anchor).

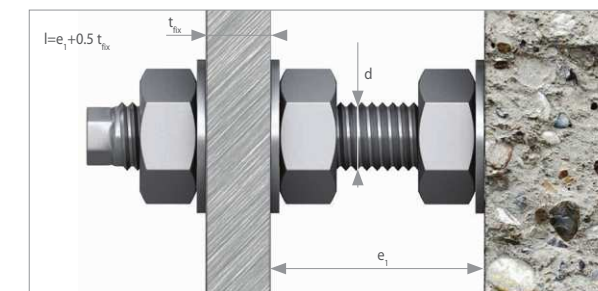

with clamping to the base material

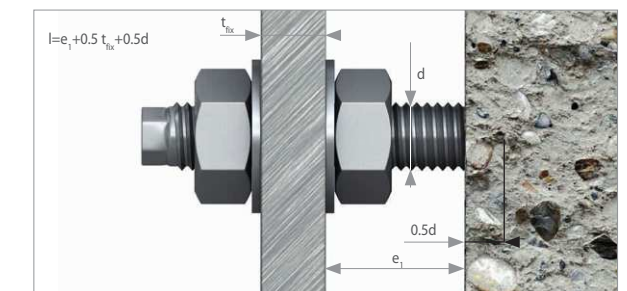

without clamping to the base material

$$M_v = V \times \frac{l}{a_m} \text{ [Nm]}$$

BASICS OF ANCHORING - TORQUE & BENDING MOMENTS

INSTALLATION OF ANCHORS

Installation guidelines are attached to all packaging for our anchors. We recommend strict adherence to all of the instructions contained therein. Debris and dust must always be removed from the hole before the anchor is installed in order to avoid risk of limiting the anchorage depth. Hole cleaning is particularly important for bonded anchors, because any debris or dust will decrease the load bearing capacity of the anchorage.

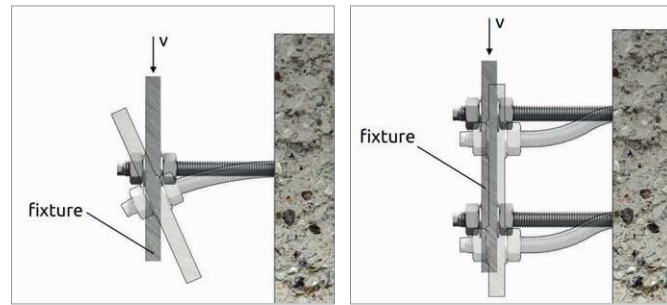

$\alpha_M = 1.0$ when element (fixture) is not fixed and can rotate freely
 $\alpha_M = 2.0$ when element (fixture) is fixed and cannot rotate

BASICS OF ANCHORING - REBAR CONNECTIONS

POST-INSTALLED REBAR CONNECTIONS

Using chemical resin, rebar can be post-installed in concrete to act as structural reinforcement or, alternatively, to create an anchorage. The role depends on the application, installation type and also the feasibility of use of a specified resin.

RAWLPLUG® offer resin products that can provide a solution in both scenarios.



REBAR INSTALLED WITH CHEMICAL RESIN AS AN ANCHOR

In many applications rebar installed with chemical resin must be designed to act as an anchorage. This scenario may arise for a number of reasons: the rebar may not be carrying the full tensile load as it would in structural reinforcement (i.e. the concrete must resist an element of the tensile loading), there may be an absence of existing cast-in reinforcement (i.e. no overlap splice to take up tensile loads), or the rebar anchorage may be subject to shear loading.

The characteristic failure mode for this type of anchorage - similarly to chemical anchors using threaded rods - is concrete cone failure, or a combination of concrete cone failure and

pull-out. It is therefore important to keep appropriate spacing and edge distances.

Embedment depths are generally smaller, compared with cases of rebar acting as structural reinforcement. They can, however, vary and for some types of RAWLPLUG® resins deeper embedments can be employed, facilitating higher performance.

Depending on the type of resin, various diameters of rebar and grades of steel can be applied.

REBAR INSTALLED WITH CHEMICAL RESIN AS STRUCTURAL REINFORCEMENT

Introduction

Both for new reinforced concrete construction requiring connection with an existing structure, and for the reinforcement, modernisation or upgrading of an existing structure, there can be a requirement to create permanent connections between new and existing construction elements. In these applications post-installed rebar connections are very useful. The aforementioned scenarios can arise when joining slabs, beams and columns, reinforcing nodes, walls and when building balconies and cantilevers.

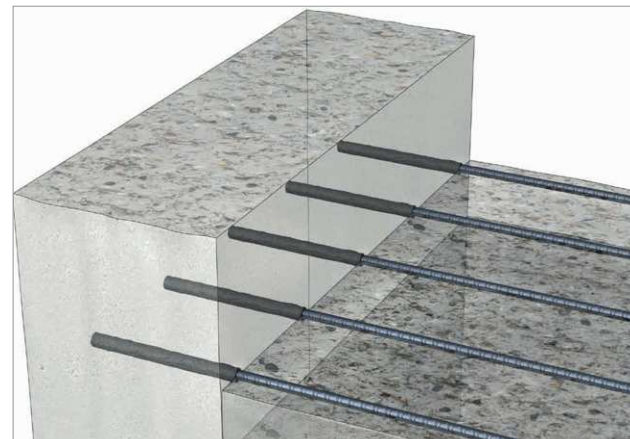

Figure 1.1: Anchorage

Depending on the type of existing construction and its reinforcement, two different types of connections can be described - anchorage (Figure 1.1), and overlap splice with existing construction rebar (Figure 1.2)

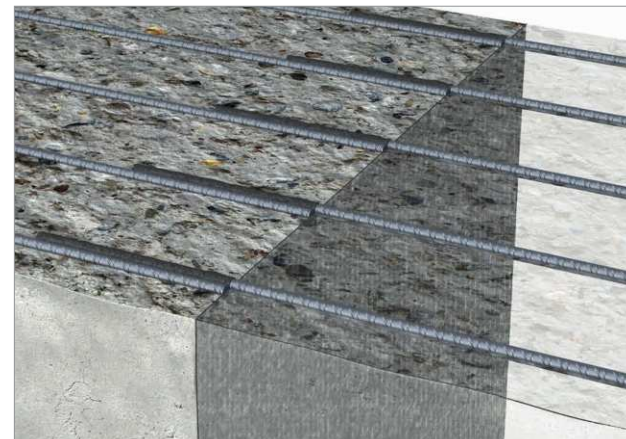

Figure 1.2: Overlap splice

BASICS OF ANCHORING - REBAR CONNECTIONS

Various applications (Figures 1-5) are covered by Technical Report TR 023 "Assessment of post-installed rebar connections", which, alongside European standard Eurocode 2 "Design of concrete structures" Part 1-1 "General rules and rules for buildings", is a fundamental document for the design and testing of these types of anchorages.

Figures 1-5 (below) show applications in which resins with rebar can be used successfully.

Examples of post-installed rebar applications

Figure 1
Overlap joint for rebar connections of slabs and beams

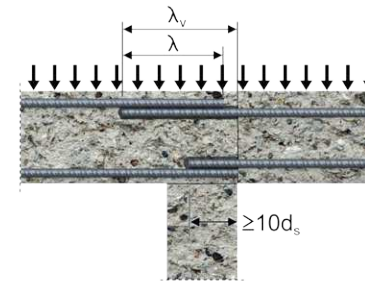

Figure 2
Overlap joint at a foundation of a column or wall where the rebars are stressed in tension

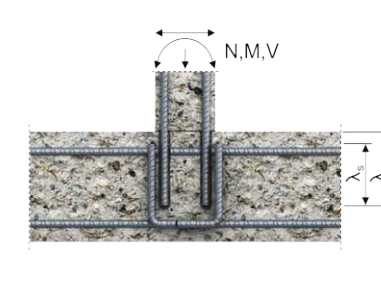

Figure 3
End anchoring of slabs or beams designed as simply supported

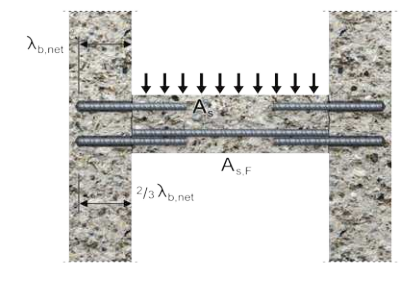

Figure 4
Rebar connection for components stressed primarily in compression. The rebars are stressed in compression

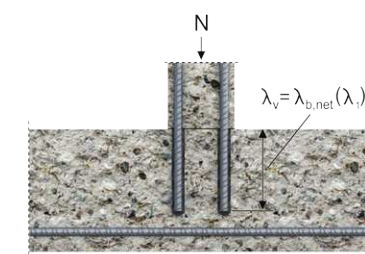
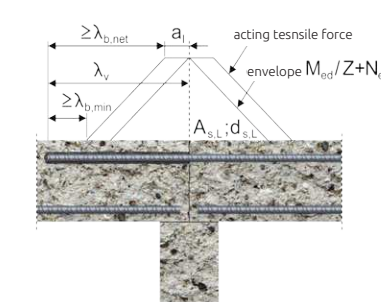

Figure 5
Anchoring of reinforcement to cover the line of acting tensile force.



Note to Figure 1-5
In the figures transverse reinforcement is not shown, however, the transverse reinforcement as required by EC2 shall be present.

The shear transfer between old and new concrete shall be designed according to EC2.

REBARS

Rebars are key elements of reinforced concrete constructions. Their role is to bear tension loads due to the fact that concrete possesses high compressive strength but very low tensile strength.

In the applications previously described, depending on construction type and implementation, rebars can form either an overlap splice effect, where new bars will extend the effect of existing rebar, or an anchorage.

In the case of post-installed rebar, loads are transferred into the concrete via the adhesion of the resin, which simultaneously dovetails with the ribs of the rebar (equivalent to the effect at the rebar-concrete interface in cast-in rebar solutions). The resin reacts like compressive struts at an angle of 45° in a strut-and-tie model.

Cooperation between bars in overlap splice is possible because of load transference between them based on a 45° truss model. Similarly to the above scenario, resin and concrete act as compressive struts.

One possible failure mode in the case of post-installed rebar is pull out failure, when resin wedges are sheared causing the rebar to act like a smooth bar (performance is determined only by friction and adhesion, as the dovetailing effect is eliminated). Another is concrete splitting failure caused by naturally occurring cracks, which run from the rebar ribs in the direction of the concrete surface. Consequently, it is important to ensure correct concrete cover and rebar spacing.

RESIN CHARACTERISTICS

Load bearing capacity is determined by adhesion forces at the rebar-resin and resin-concrete interfaces, as well as the strength characteristics of the steel elements used. Of subsequent importance is the resin bond strength, which should be equal to or greater in strength than the concrete. Accordingly, to permit the use of a given resin in the applications described previously, it needs to be tested according to TR 023 "Assessment of post-installed rebar connections" to obtain Technical Approval. TR 023

covers post-installed rebar connections designed in accordance with the EN standard Eurocode 2 "Design of concrete structures", Part 1-1 "General rules and rules for buildings", on the assumption that only tension loads can be transferred, shear loads are not considered and transverse reinforcement should be designed in addition, based on Eurocode 2. The base material is non-carbonated concrete of class C12/15 – C50/60. Post-installed rebar are straight rein-

BASICS OF ANCHORING - REBAR CONNECTIONS

forcing bar with properties according to Eurocode 2, Annex C, with classes B and C recommended. The Technical Report does not cover fire resistance, fatigue, dynamic or seismic loading of post-installed rebar connection. Among others, tests include: tests for bond resistance in C20/25 and C50/60, installation safety tests in dry and wet concrete, functioning under sustained loads, functioning under freeze/thaw conditions, installation at maximum embedment depth, and correct injection. Proof is required that post-installed rebar connections function like cast-in rebar – with comparable load transference and displacement behaviour.

This is demonstrated by achieving appropriate bond resistance f_{bd} . **Figure 6:** Design according to EC2 without limitation compared with cast-in rebar bond strength. The necessary bond resistance for connections designed according to Eurocode 2 for different concrete classes is shown in Figure 6. For resins having a bond resistance smaller than that assumed, values based on testing and decreased according to levels from TR 023 should be included in the technical approval.

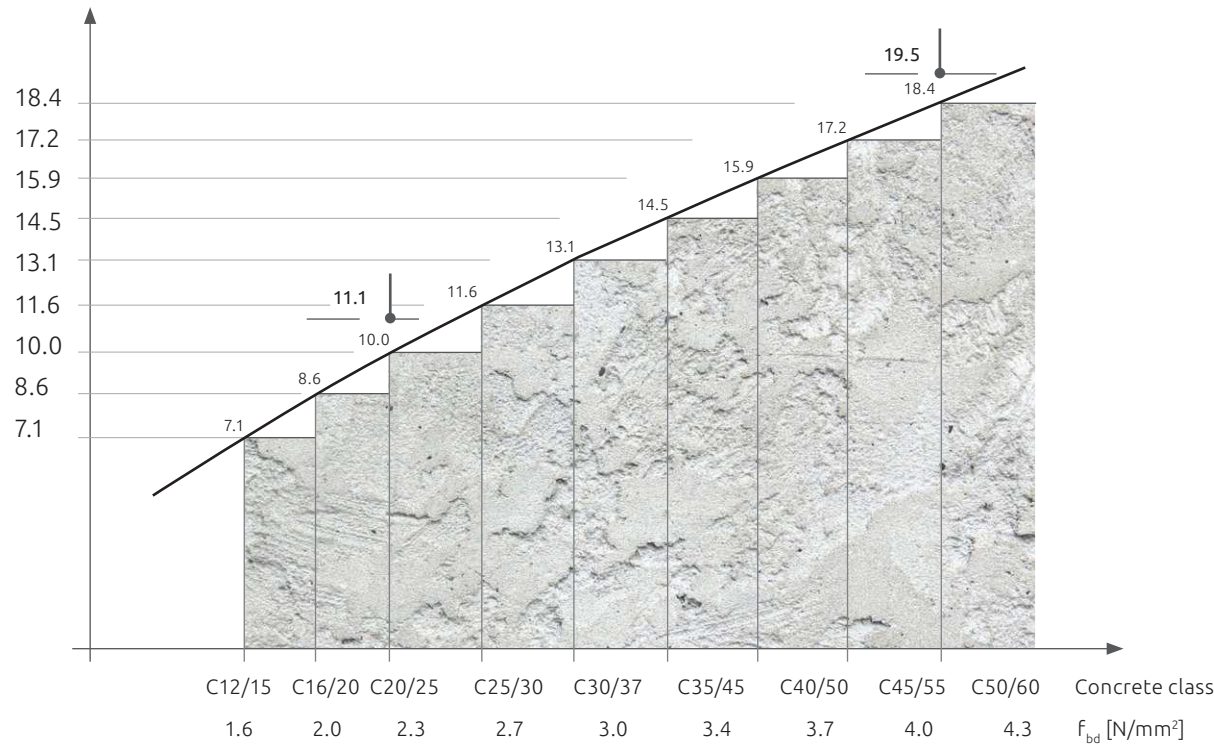

DESIGN OF ANCHORAGE AND SPLICE OVERLAP CONNECTIONS

Connections should be designed in accordance with obligatory rules for the design of reinforced concrete structures, taking into account the load distribution on the construction and its nodes. It is very important to determine and factor in the existing reinforcement layout.

An approval contains bond resistance values depending on concrete class and rebar diameter, data for concrete cover, minimum and maximum embedment depth and lap splice, as well as general rules for rebar arrangement.

Technical Approvals, obtained based on Technical Report TR 023, and Eurocode 2, Part 1-1 are the primary reference documents for determining internal load distribution in sections and for the design of these types of connections.

Meanwhile Eurocode 2 covers the design of reinforced concrete structures, facilitating determination of internal load distribution and calculation of embedment depth or overlap splice, taking into account factors such as: bond conditions, rebar shape, concrete cover and transverse reinforcement.

The first value calculated in the design process, according to Eurocode 2, is basic anchorage length:

$$l_{b,rd} = \left(\frac{\sigma_{sd}}{f_{bd}}\right) \cdot \left(\frac{\sigma_{sd}}{f_{bd}}\right)$$

where:
 σ_{sd} – anchorage rebar diameter
 σ_{sd} – design stress of the bar
 f_{bd} – design value of the ultimate bond resistance according to corresponding ETA

BASICS OF ANCHORING - REBAR CONNECTIONS

DESIGN ANCHORAGE LENGTH FOR ANCHORAGES

The next value to consider is the design anchorage length calculated as follows.

$$l_{bd} = \alpha_1 \alpha_2 \alpha_3 \alpha_4 \alpha_5 l_{b,rd}$$

α_1 – α_5 – coefficients acc. to EC2, Tab. 8.2
 α_1 – effect of the form of the bars assuming adequate cover (1.0 for straight bar in tension and in compression)
 α_2 – effect of concrete minimum cover (acc. to EC2, Figure 8.3)

$$0.7 \leq \alpha_2 \leq 1.00$$

$$\alpha_2 = 1 - 0.15 \frac{c_d - \phi}{\phi} \text{ – rebar in tension}$$

$$\alpha_2 = 1.0 \text{ – rebar in compression}$$

$$c_d = \min \{0.5a; c_1; c\} \text{ – for straight bars (acc. to EC2, Figure 8.3)}$$

α_3 – the effect of confinement by transverse reinforcement not welded to main reinforcement
 $\alpha_3 = 1.0$ when no transverse reinforcement or no influence

$$0.7 \leq \alpha_3 \leq 1.00$$

$$\alpha_3 = 1 - K \times \lambda \text{ – rebar in tension}$$

$$\alpha_3 = 1.0 \text{ – rebar in compression}$$

$$K \text{ – values for beams and slabs acc. to EC2, Figure 8.4}$$

$$\lambda = \frac{\sum A_{st} - \sum A_{st,min}}{A_s}$$

$\sum A_{st}$ – cross-sectional area of the transverse reinforcement along the design anchorage length l_{bd}
 $\sum A_{st,min}$ – cross-sectional area of the minimum transverse reinforcement

A_s – area of a single anchored bar with maximum bar diameter
 α_4 – influence of one or more welded transverse bars along the design anchorage length,
 $\alpha_4 = 1.0$ when no transverse reinforcement or no influence
 α_5 – the effect of the pressure transverse to the plane of splitting along the design anchorage length

$$0.7 \leq \alpha_5 \leq 1.0$$

$$\alpha_5 = 1 - 0.04 \rho \text{ (only rebar in tension)}$$

$$\rho \text{ – transverse pressure at ultimate limit state along } l_{bd}$$

Product of $\alpha_2 \alpha_3 \alpha_5$ must fulfil: $\alpha_2 \alpha_3 \alpha_5 \geq 0.7$
 Design anchorage length must be in the range between minimum and maximum anchorage length:

$$l_{b,min} \leq l_{bd} \leq l_{v,max}$$

$l_{b,min}$ – minimum anchorage length
 $l_{b,min} = \max \{0.3 l_{b,rd}; 10\phi; 100 \text{ mm}\}$ – rebar in tension
 $l_{b,min} = \max \{0.6 l_{b,rd}; 10\phi; 100 \text{ mm}\}$ – rebar in compression
 $l_{v,max}$ – maximum embedment depth, from ETA

DESIGN EMBEDMENT LENGTH FOR OVERLAP SPLICE

$$l_0 = \alpha_1 \alpha_2 \alpha_3 \alpha_5 \alpha_6 l_{b,rd}$$

α_1 – α_5 – as above
 α_6 – influence of overlap splice relative to the total cross-section area

$$\alpha_6 = \sqrt{\frac{\rho_l}{25}} \text{ , } 1.0 \leq \alpha_6 \leq 1.5$$

ρ_l – percentage of reinforcement lapped within $0.65 l_0$ from the centre of the lap length considered, acc. to EC2, Tab.8.3
 Design lap splice length must be in the range between minimum and maximum lap splice length:

$$l_{0,min} \leq l_0 \leq l_{v,max} - c_1$$

$l_{0,min}$ – minimum lap splice length
 $l_{0,min} = \max \{0.3 \alpha_6 l_{b,rd}; 15\phi; 200 \text{ mm}\}$
 $l_{v,max}$ – maximum embedment depth, from ETA
 c_1 – concrete cover at frontal concrete surface

Embedment depth for lap splice connections:

$$l_v \geq l_0 + c_1$$

» The clear distance between lapped bars should not be greater than 4ϕ , or else the lap length should be increased by a length equal to the difference between the clear space and 4ϕ

- » Minimum concrete cover is stated in appropriate ETA, whilst minimum cover should also be kept acc. to EC2, chapter 4.4.1.2
- » Transverse reinforcement should be designed acc. to EC2, chapter 8.7.4
- » Connections between existing and new concrete should be designed according to EC2
- » Minimum clear spacing between bars is kept according to ETA requirements

Connections between existing and new concrete
 Connections between existing and new concrete should be designed according to EC2.

The surface of the joint should be prepared, for example roughened to expose aggregate. If the surface of the existing concrete is carbonated, the layer should be removed in the area of the new reinforcing bar prior to installation.

The above directions may be disregarded in cases where building components are new, not carbonated and the environment conforms to dry condition criteria.

Design process using RAWPLUG® EasyFix software

The EasyFix program functions as a helpful tool in the design of post-installed rebar connections, both in cases of chemical anchorage and structural reinforcement. The program includes a Calculator for calculation and selection of anchors, a Resin Consumption Calculator for chemical resins and a Post-Installed Connection module for anchorage and lap splices, for use in both new and existing structures.



EasyFix
POST INSTALLED REBAR Module

ANCHORS – POST INSTALLED REBAR - MANUAL

1 Selection of The product category
Designing methods:
EUROCODE 2 | EN 1992-1-1
PIRR | Post Installed Rebar Rawlplug



2 Defining of The existing construction
Determining and defining the geometry of the existing structure requires knowledge of the details of the concrete in which to anchor. In example concrete class, steel yield strength, element dimensions.

Determining of the construction type:
Plate | Beam | Wall | Column | Foundation

Determining of the structure dimensions:
The geometry of the structure can be specified in the side panel or on the model

Determining of the concrete strength class:
Entering data by selecting from the list or the option "by user"

Determining of the yield steel strength:
Entering data by selecting from the list or the option "by user"

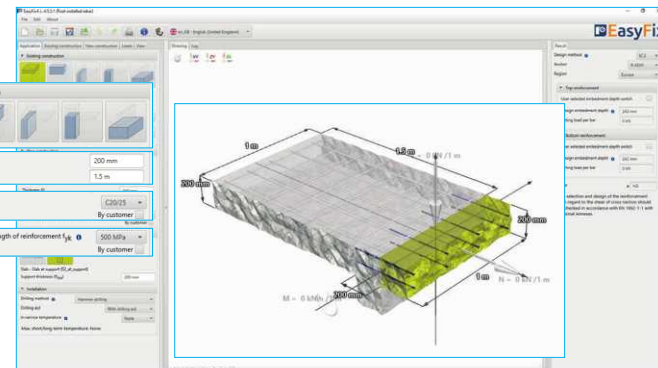

BONDED ANCHORS - DESIGN SOFTWARE



ANCHORS – POST INSTALLED REBAR - MANUAL

2 Defining of The existing construction

Determining of the concrete strength class:

Selecting from the list:
Concrete strength class according to standard EN 206
Option „by user“:
Possibility of manual input of characteristic compressive strength of cylinder f_{ck} ,
or
Possibility of manual input of characteristic compressive strength of cube $f_{ck,cube}$

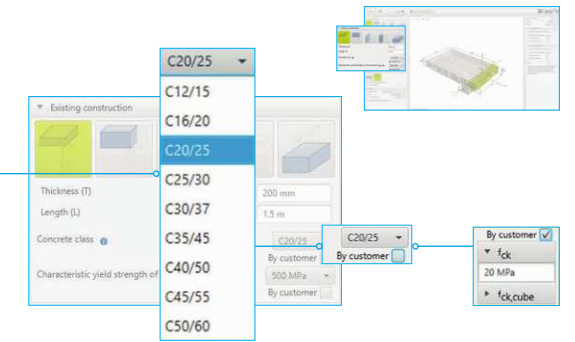

2 Defining of The existing construction

Determining of the yield steel strength:

Selecting from the list:
Reinforcement according to standard EN 1992-1-1:2008
Option „by user“:
Possibility of manual input yield steel strength f_{yk} and its safety factor γ_s according to national requirements

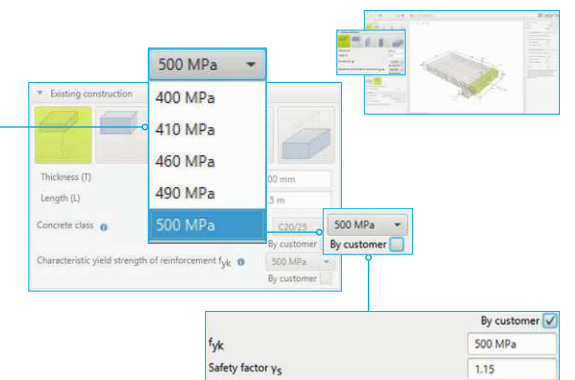

3 Defining of The new construction

Determining and defining the geometry of a new structure requires the knowledge of details, i.e., the steel yield strength, dimensions of the element, layout and diameter of the anchored rebars.

Determining of the construction type:
Depending on the geometry of the existing construction, there is a choice between:
Plate | Beam | Wall | Column

Determining of the structure dimensions:
The geometry of the structure can be specified in the side panel or on the model

Determining the position of the structure:
Inputting a possible shift of the new structure in relation to the existing one

Determining of the yield steel strength:
Entering data by selecting from the list or the option "by user"

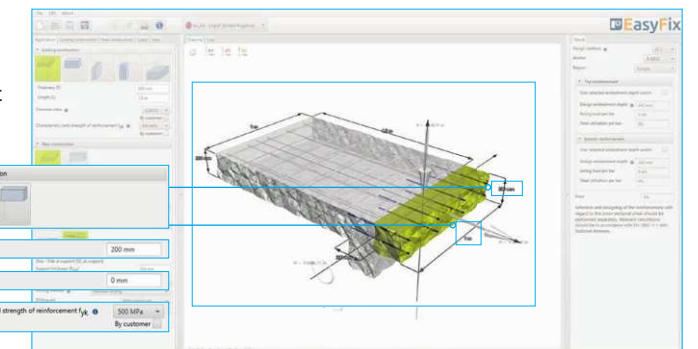

3 Defining of The new construction

Determining of the construction type:
Depending on the geometry of the existing construction, there is a choice between:

- Plate – Plate | Beam
- Beam – Beam | Plate
- Wall – Plate | Beam | Wall
- Column – Beam | Column
- Foundation – Wall | Column

Plate – Plate | Beam



Wall – Plate | Beam | Wall



Column – Beam | Column



Foundation – Wall | Column



ANCHORS – POST INSTALLED REBAR - MANUAL

3 Defining of The new construction

Determining of the yield steel strength:

Selecting from the list:
Reinforcement according to standard EN 1992-1-1:2008

Option „by user“:
Possibility of manual input yield steel strength f_{yk} and its safety factor γ_s according to national requirements.

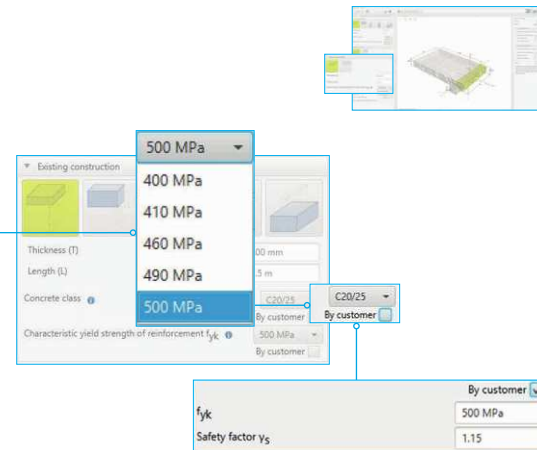

4 Defining of Construction and its application

The Application panel is used to detail the type of structure and its use. Here we define information on the cooperation of the existing and new elements

Determining of the type of construction:

Depending on the type of structure, determining the exact work of the structure along with the required dimensions.

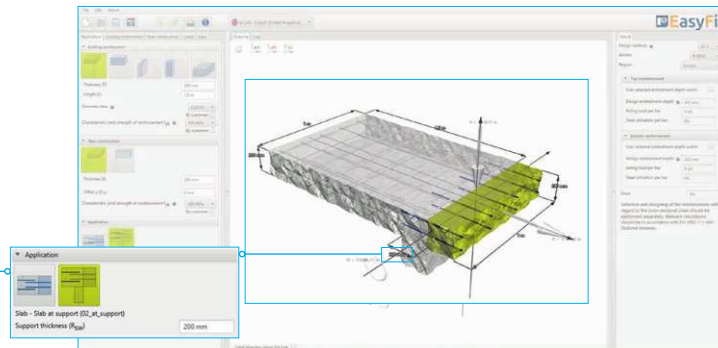

3 Defining of Construction and its application

Determining of the type of construction:

- Depending on geometry of existing structure:
- The structure without support
 - The structure with support
 - The structure simply supported
 - Elongation of the structure
 - Compression of the structure
 - Calculation of lap length

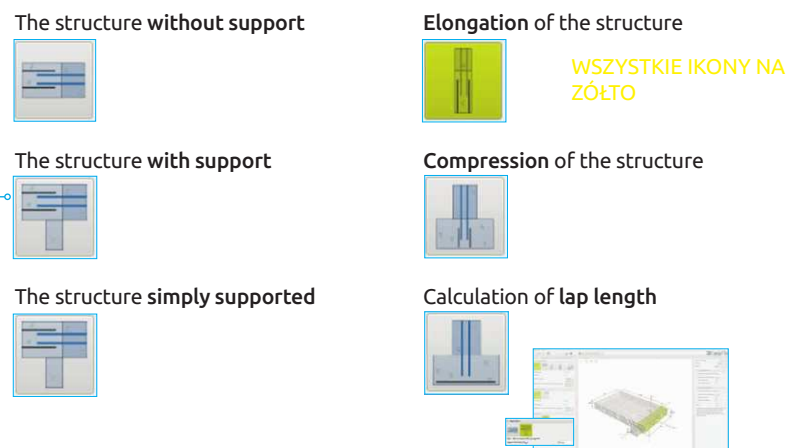

4 Conditions of The installation

Determination and defining of the drilling method in the existing structure. The selection of the drilling method affects on the thickness of the concrete cover. The choice of the service temperature determines the minimum and maximum temperature of the substrate at the time of installation of the anchor.

Determining of drilling method:

Selecting from the list:
Hammer | Diamond

Determining of service temperature:

Selecting from the list of results filters the proper anchor group

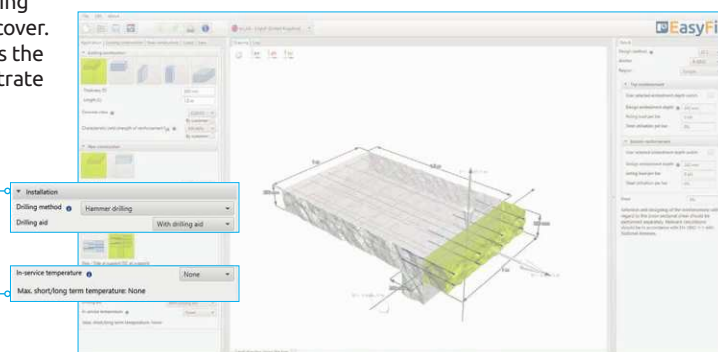

ANCHORS – POST INSTALLED REBAR - MANUAL

5 Conditions of The Installation

Determining of drilling method:

- Selecting from the list:
- Hammer drilling
 - Hammer drilling with hollow drill bit
 - Compressed air drilling
 - Diamond drilling

Selecting from the list of results filters the proper anchor group

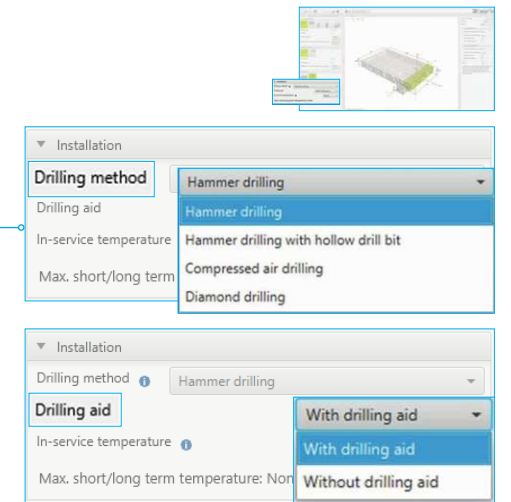

5 Conditions of The Installation

Determining of service temperature range

- Selecting from the list:
- 40° C ÷ + 40° C
 - 40° C ÷ + 80° C
 - 40° C ÷ + 120° C

For the appropriate range, the program displays information about the range of short and long-term work.

Selecting from the list of results filters the proper anchor group

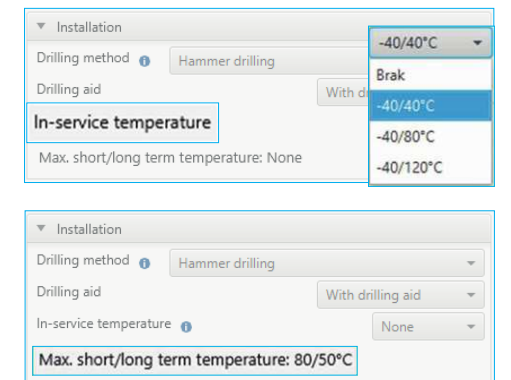

6 Reinforcement of the existing construction

Defining reinforcement in an existing structure enables entering data in a simplified or detailed way. The detail model allows you to move the reinforcement in relation to the appropriate axis. Top and bottom reinforcement is defined for each layer.

Defining the input data:

- Longitudinal bars:**
- The diameter of the bars
 - Cover thickness - top|bottom
 - Spacing | number of bars
- Transverse bars:**
- The diameter of the bars
 - Spacing

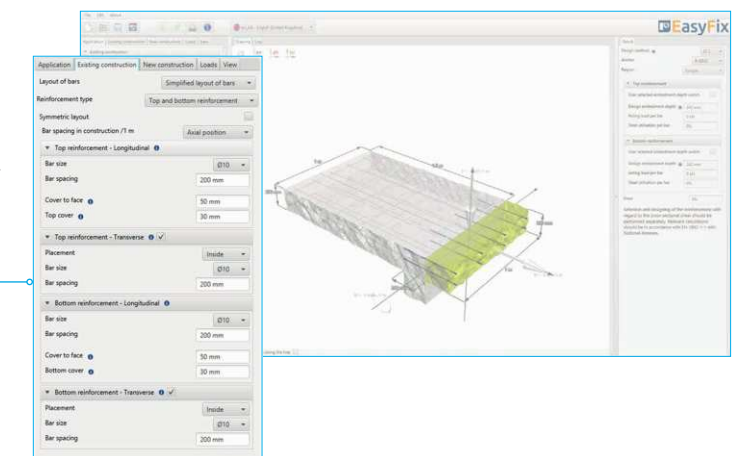

6 Reinforcement of the existing construction

Determination of bars layer:

- Selecting from the list:
- Simplified bars layout
 - Detailed bars layout.
- It allows to move the reinforcement in relation to the appropriate axis

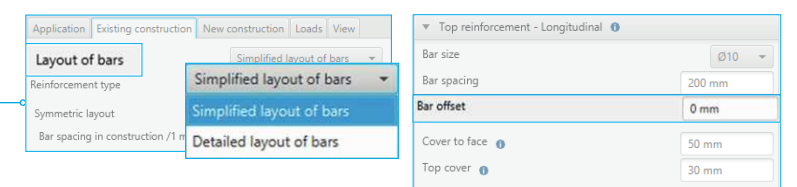

Determination of positioning of rebar:

- Selecting from the list:
- Top and bottom reinforcement
 - Top reinforcement
 - Bottom reinforcement
 - None

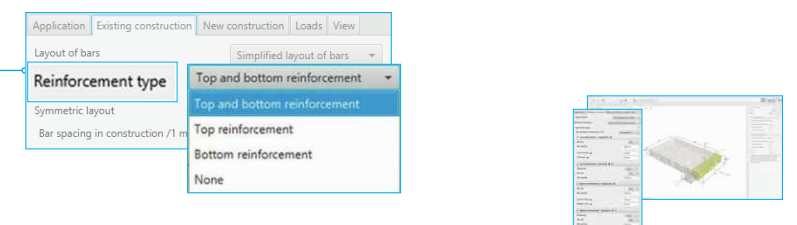

ANCHORS – POST INSTALLED REBAR - MANUAL

Z KATALOGU CZ. DOT REBAR

6 Reinforcement of the existing construction

The diameter of longitudinal reinforcement

Thickness of concrete cover face

Thickness of top and bottom concrete cover

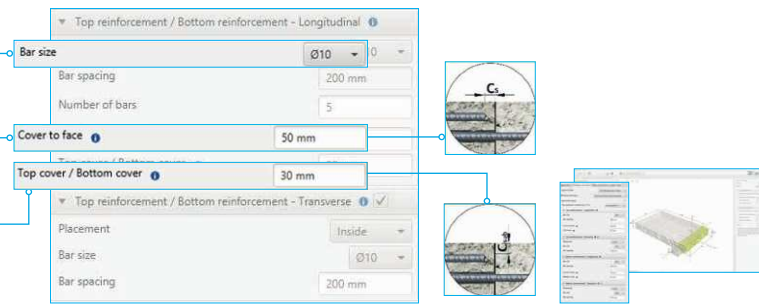

6 Reinforcement of the existing construction

Positioning of the transverse reinforcement: Internal | External of longitudinal reinforcement

The diameter of the transverse reinforcement or stirrups

The spacing of the transverse reinforcement

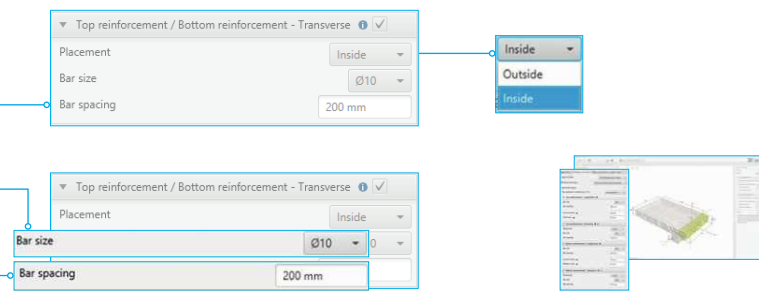

7 Determination of reinforcement in the new construction

Defining reinforcement in a new structure enables entering data in a simplified or detailed manner. The detail model allows to move the reinforcement in relation to the appropriate axis. Top and bottom reinforcement is defined for each layer. Possibility to add an additional row of bars in each layer.

Defining the input data:

- Longitudinal bars:
 - The diameter of the bars
 - Cover thickness - top| bottom
 - Spacing | number of bars

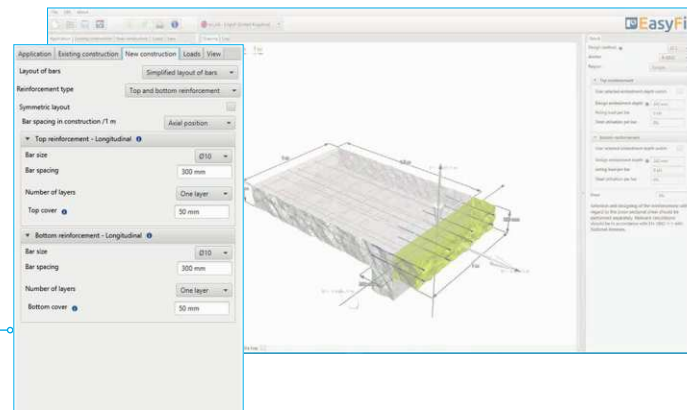

7 Determination of reinforcement in the new construction

Symmetric layout: Selecting this option allows to enter data for the top and bottom reinforcement, which have the same layer system, at the same time.

Determining of reinforcement spacing:

- Selecting from the list:
 - Axial spacing
 - Number of bars

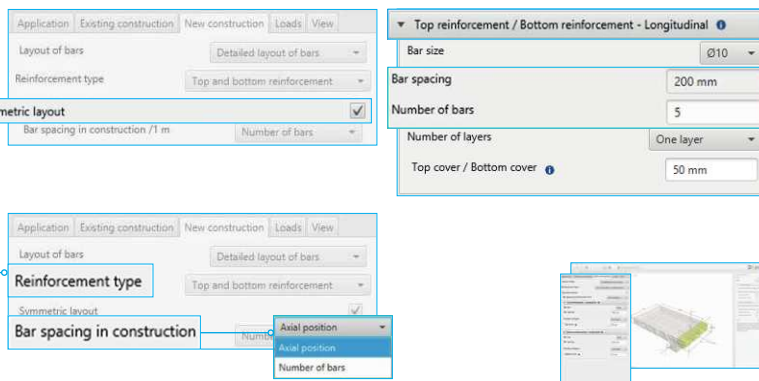

ANCHORS – POST INSTALLED REBAR - MANUAL

7 Determination of reinforcement in the new construction

The diameter of longitudinal reinforcement

Determination of number of concrete cover face

Thickness of top | bottom concrete cover

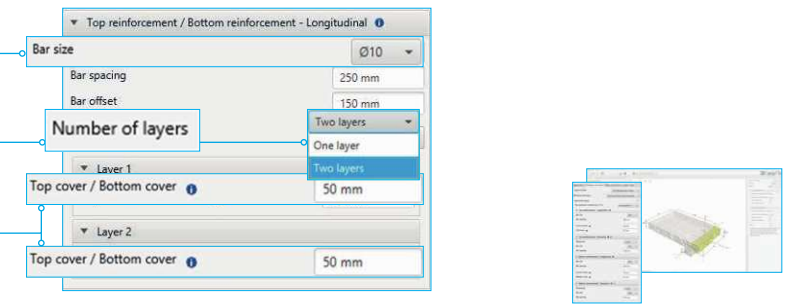

8 Defining of acting load

Defining of the load depends on the type of structure or the constructor's assumptions. It is also possible to enter loads from the model level. Depending on the work of the structure, it is also possible to take into account the transverse reinforcement and transverse pressure. According to the theory described in Eurocode 2 (EN 1992-4) Part 1

Defining the input data:

- Selecting from the list:
 - Acting load per meter | cross section
 - Acting load per bar
 - Load per yield strength

Including the transverse pressure

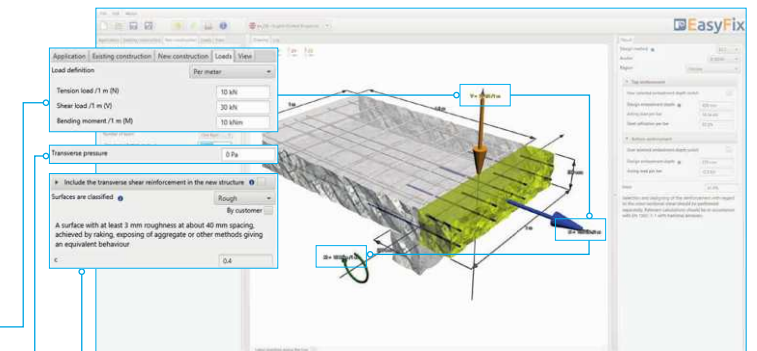

Including the transverse shear reinforcement in the new structure

8 Defining of acting load

Acting load per meter | cross section

Acting load per bar

Defining of load per yield strength

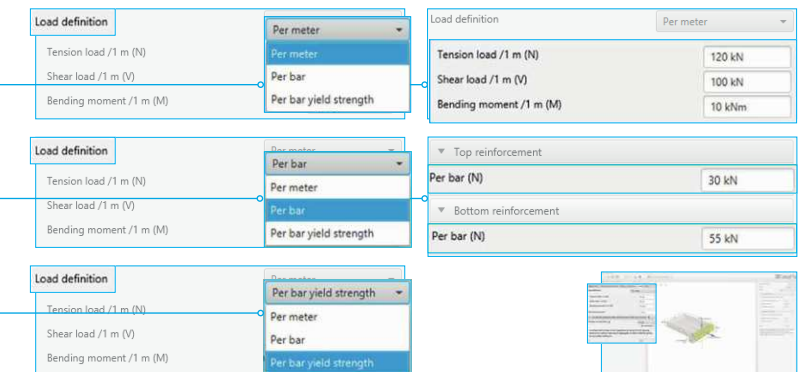

8 Defining of acting load

Including the transverse shear reinforcement in the new structure

- α - the angle between shear reinforcement and the main tension chord
 - β - the angle between concrete compression struts and the main tension chord

Including Roughness of old concrete surface

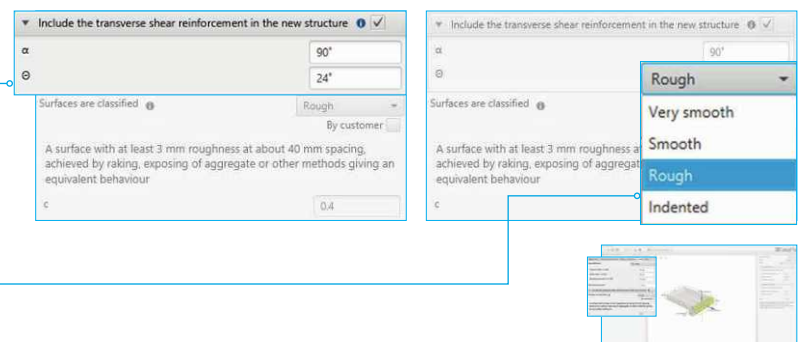

BONDED ANCHORS - DESIGN SOFTWARE



ANCHORS – POST INSTALLED REBAR - MANUAL

9 Analysis of the results

In the results panel, we can choose a design method between the calculation of the anchorage according to the standards contained in Eurocode 2 and the PIRR engineering method. In addition, it is possible to filter products and the region in which the products will be used.

Panel of filters:

- Design method
- Type of resin
- Region

Results of top reinforcement

For both layers, if there's more than one

Results of bottom reinforcement

For both layers, if there's more than one

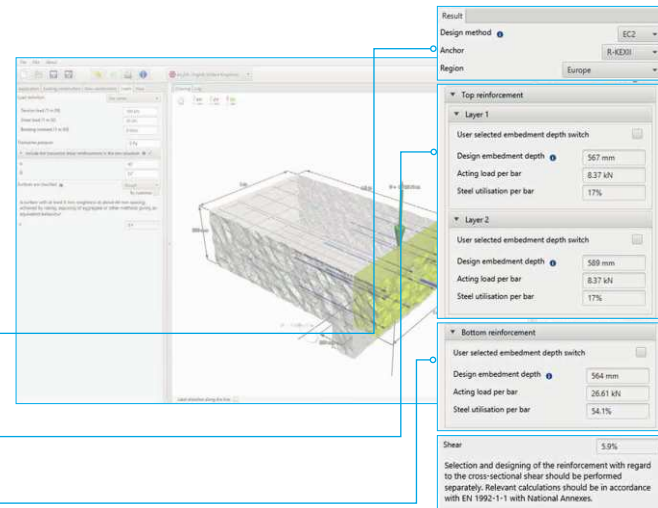

Verification of shear loads

The results depends on the influence of the transverse shear reinforcement in the new structure.

9 Analysis of the results

Design method

- Eurocode 2
- Post Installed Rebar Rawplug

Selecting a product

from the list available for a given region

Selecting the region

where the product will apply

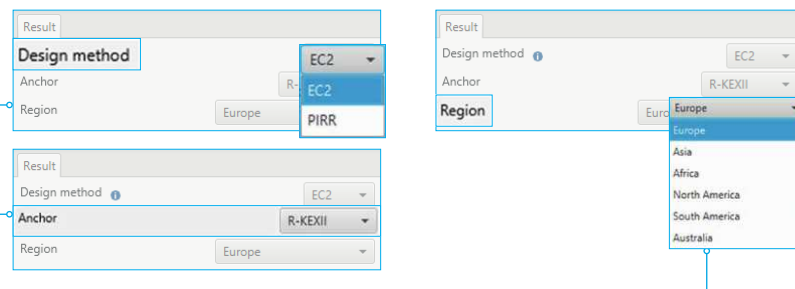

9 Analysis of the results

The results are shown separately for each layer

Possibility to enter the declared anchorage depth, not less than the calculated value

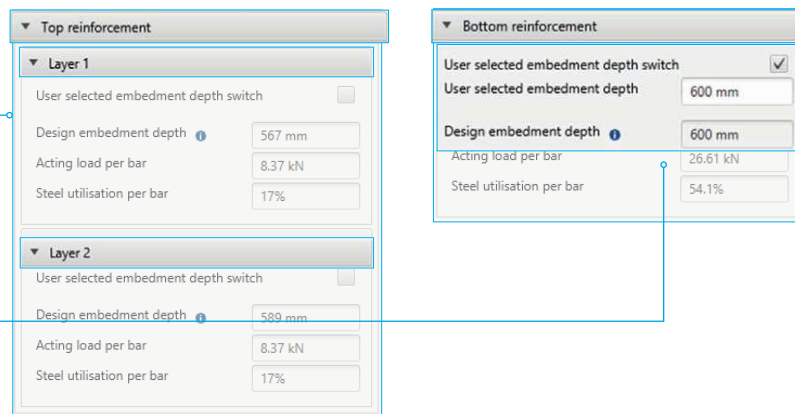

10 Generation The printout

Print option

Enables you to generate a document in a pdf format

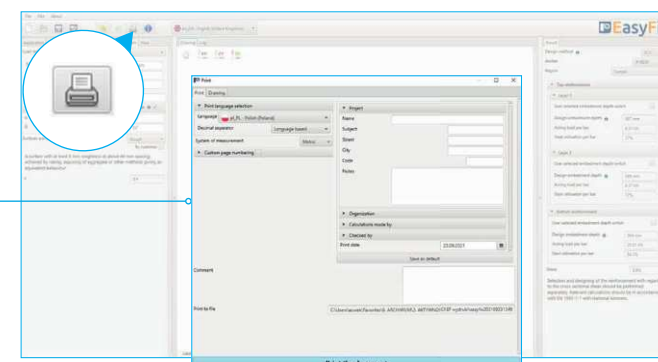

BASICS OF ANCHORING - DESIGN SOFTWARE



RAWPLUG EASYFIX IS AN INNOVATIVE APPLICATION

Making it possible to run design calculations for the fixing of different construction elements using Rawplug brand products.

The individual program modules are dedicated to specific segments of construction works. Each of them enables real-time calculations, giving the user virtually unlimited possibilities of matching fixings and the elements to be fixed to the actual needs at the given time.

In addition, program modules covering the individual areas contain installation elements chosen taking into account the particular needs resulting from the diverse applications found in construction projects.

- Anchoring elements in various substrates
- Constructive pasting of rebar
- Wind calculations
- Road and bridge calculations
- Calculations for joining timber elements

RAWPLUG EASYFIX IS INTENDED FOR PROFESSIONAL USE BY:

- Designers
- Architects
- Contractors

WHAT FOR?

Designing structures using reliable fixings, regardless of the type and scale of the investment.

WHY?

Functionality and comfort are the two most straightforward words that summarise the advantages which the EasyFix application offers. It is good to know more about the key ones. Firstly, Individual EasyFix modules contain comprehensive information based on up-to-date guidelines intended for the given solution. Secondly, the program's interface is easy-to-use, transparent and very intuitive. Thirdly, what you receive is real-time display of results, meaning that on-screen results of the calculations you rely on are shown immediately after each modification of input data. Fourthly, the available set of both typical and highly specific filters allows you to find the optimum solution. Fifthly, the program's additional features enable optimisation of the elements to be fixed at an early stage of design work. And sixthly, the application enables you to pick items from an extensive database of BIM and CAD models and Technical drawings rendered available by the BIM Rawplug software, which makes both programs fully complementary.

Calculations pertaining to specific aspects are conducted using modules dedicated to individual segments of construction works. Each offers specific features that enable quick, precise and highly useful calculations which take the nature of the given scope of works into consideration.

RAWPLUG EASYFIX IS AN ORIGINAL TOOL

Developed by a specialised team of experts working with industry professionals on a daily basis, watching them in action and tracking their expectations. EasyFix stems from discussions about the personal and business-related needs of our customers, about their experiences and about the solutions they seek.

Rawplug EasyFix is created on the basis of latest design guidelines in accordance with EAD, ETAG and Eurocodes, which guarantees compliance with the standards, accuracy and top utility value.

It is also important is that the program is updated and improved on a systematic basis, taking into account amendments to the applicable regulations, the latest tests of Rawplug's products, as well as current market trends.

This is precisely what makes EasyFix a complementary response to real-life needs of architects, design engineers and contractors.

RAWPLUG EASYFIX APPLICATION

- Designing fixings for concrete substrates.
- Designing post-installed rebar anchoring in concrete substrates.
- Designing fixings taking into account wind load.
- Designing fixings in timber structures.
- Designing road and bridge construction fixings.

BASICS OF ANCHORING - DESIGN SOFTWARE



RAWPLUG EASYFIX APPLICATION

CALCULATION CATEGORIES	MODULE TYPE	COMPLIANCE OF MODULES WITH THE APPLICABLE GUIDELINES
ANCHORS – designing structural fixings using threaded rods, rebars and threaded sleeves in concrete and masonry substrates.	CONCRETE	Two modules used for the calculation of structural fixings in concrete substrates. The calculations are based on guidelines included in EN-1992-4, ETAG 001 Annex C, TR 029 CEN/TS-1992-4, FIB and ACI 318-11.
	BALUSTRADE	
	MASONRY	
STRUCTURAL REBAR JOINTS – designing rebars in concrete substrates.	REBAR	Calculations based on EOTA Technical Report TR 029, ETAG 020, for masonry substrates made of materials classified in categories B, C, D.
	CONCRETE INTERFACE REINFORCEMENT	This module makes it possible to determine the required design rebar anchorage length in reinforced concrete structures based on the guidelines included in EN 1992-1-1 and in Technical Report TR 023.
	ROOF module	The task of the module is to calculate the reinforcement at the interface between concrete elements cast at different times based on PN-EN 1992-1-1.
WIND CALCULATIONS – designing fixings taking into account the loads resulting from the action of wind on roof and facade elements.	FACADE	The modules in this category are used to perform calculations for elements fixing materials exposed to direct wind action. The calculations are based on the European wind standard EN 1991-1-4 taking into account the national annexes and other national standards for wind action on structures.
	SHEET METAL SCREWS	
	COMPOSITE PANEL SCREWS	
	PLINTH ANCHOR	
ROAD & BRIDGE CALCULATIONS – designing fixings for infrastructural elements of roads and bridges in concrete substrates.	CONCRETE INTERFACE REINFORCEMENT	Modules in this category make it possible to perform calculations for road and bridge infrastructure element joints taking into account the specific nature of such construction works. The calculations are based on EN 1991-1-4 taking into account standards dedicated to road engineering: EN 1991-2, EN 40-3-1 and EN 1794-1.
	BALUSTRADE	
	CRASH BARRIER	
	LAMPPOST	
	NOISE BARRIER	
	NOISE BARRIER	
STRUCTURAL SCREWS FOR TIMBER – calculation and selection of screws for timber substrates	PRIMARY CONNECTIONS	Screw selection and calculations are based on EN 1995-1-1 for timber and wood-based substrates classified in the EN 338 and EN 14080 standards. Different types of joints found in timber structures are listed here.
	PRIMARY TO SECONDARY BEAM CONNECTIONS	
	SUPPORT REINFORCEMENT	
	BREAK REINFORCEMENT	
	RAFTER INSULATION	

EXAMPLE



CONCRETE MODULE

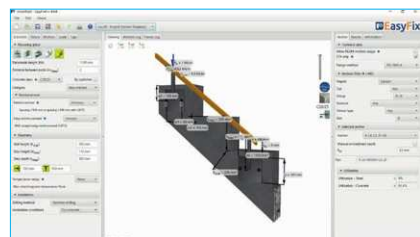

BALUSTRADE MODULE

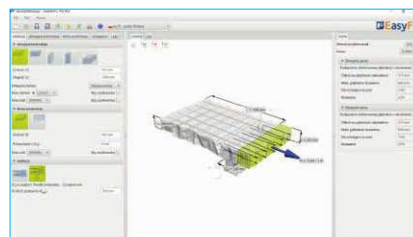

REBAR MODULE

BASICS OF ANCHORING - DESIGN SOFTWARE



THERE ARE TWO WAYS OF ACCESSING THE SOFTWARE:

INSTALL THE EASYFIX APPLICATION

You can use the EasyFix application free of charge, and you can download it from two sources: under the Services /EasyFix tab on www.rawplug.com or from the dedicated website www.easyfix.rawplug.com. To access the program, just download the installation file by clicking the Download EasyFix button – the installation will start automatically when the file is opened. The program is available for Windows and iOS. A short registration process is required to use all the advanced program functions. It only takes a moment to set up an account – go to the Register tab, which can be found at www.easyfix.rawplug.com. Enter your e-mail address and a password of your choice in the fields provided. Submission of additional information, such as occupation, company or phone number, is optional: it will be used exclusively for further development of the program, as knowledge about the most frequently occurring job profile of the users will make it possible to develop specific functions of the application. After filling in the form, you will receive an e-mail confirming your registration and an individual access key. Entering the key in the program will give you access to all of its functions for an unlimited time.

UPDATED THE SOFTWARE

The installed software automatically checks for module and database updates. You only need internet access and you have to accept the update terms and conditions.

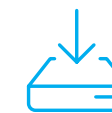
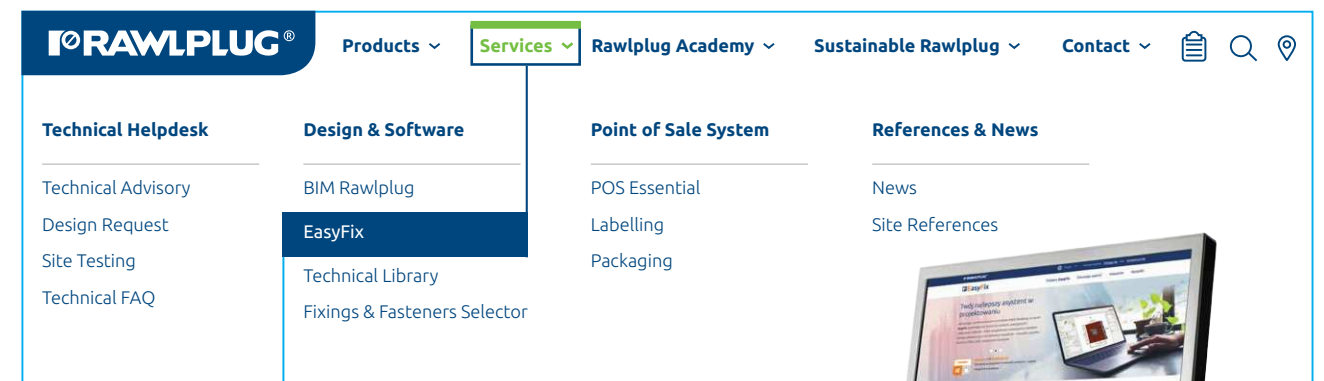
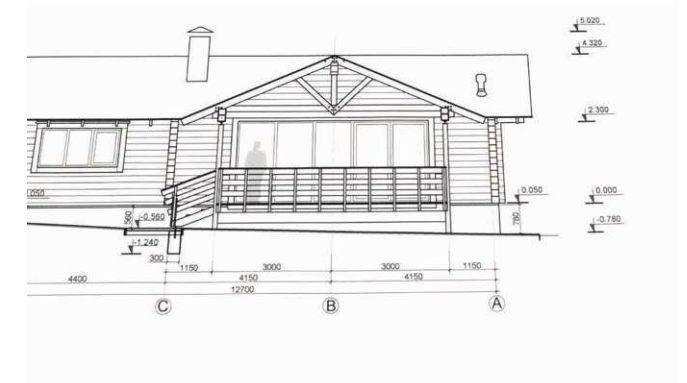

DOWNLOAD THE SOFTWARE FROM WWW.RAWPLUG.COM
<https://easyfix.rawplug.com/download-easyfix/>



REGISTRATION INSTRUCTION - MANUAL

Where to find the website?

- Location EasyFix website
Click on the active link: www.easyfix.rawplug.com



BASICS OF ANCHORING - DESIGN SOFTWARE

EasyFix

REGISTRATION INSTRUCTION - MANUAL

How to register correctly?

2 Registration EasyFix website

Thanks to registration you will receive a personalized EasyFix license key. The key is free and lifetime for all program updates. **Click the "Register" button to go to the registration form**
The license key must be entered into the EasyFix program within 30 days of installing the software - otherwise access to the program will be automatically blocked until the key is entered.

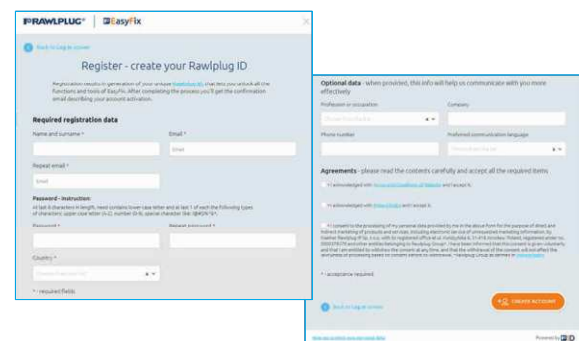

How to register correctly?

3 Registration form EasyFix website

Fill in all required fields and create an account
After creating the account you will receive an e-mail to the e-mail address provided.

How to register correctly?

4 E-mail EasyFix website

Confirm your registration by clicking the activation button in the e-mail sent to you.
If you cannot see the message in your inbox check your "Junk Email" folder.

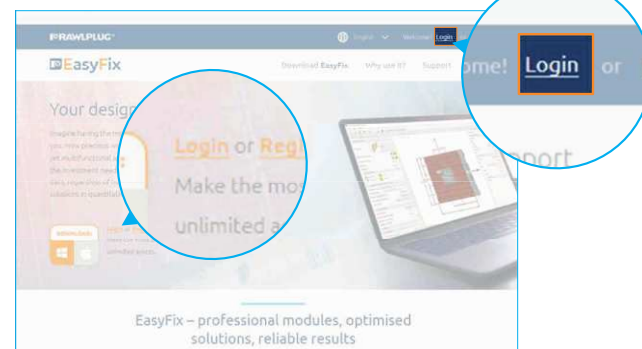
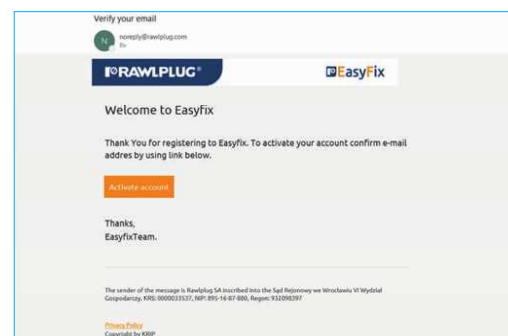

How to log in correctly?

5 Login EasyFix website

After first time logging you will receive a personalized EasyFix license key. **Click the "Log in" button to go to the login form**
After clicking the activation button in the e-mail you will be automatically redirected to the login form.

How to log in correctly?

6 Login EasyFix website

Log in using the data you provided during registration.
If you have forgotten your password use the "Forgot your password?" function.

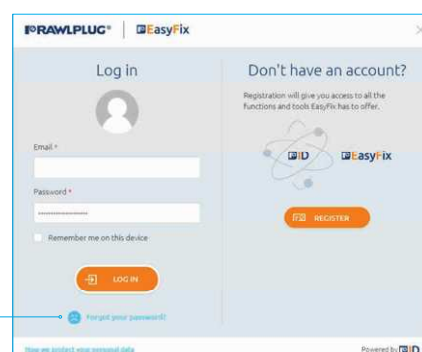

BASICS OF ANCHORING - DESIGN SOFTWARE

EasyFix

REGISTRATION INSTRUCTION - MANUAL

How to get the key?

7 Account EasyFix website

After the first successful login the page with your EasyFix key will be displayed. Your key will also be sent automatically to your e-mail.

Click on the "copy the key to the clipboard" option to save the key in the computer's memory and then paste it directly into the EasyFix program.



How to download EasyFix?

8 Downloading EasyFix website

Go to the "download EasyFix" section and click on the software icon to download the appropriate EasyFix installation file.

While the software is downloading you can refer to the installation instructions in the window that will be displayed automatically after the download starts.

How to install EasyFix?

9 Installation EasyFix software

Find the installation file on your computer and install the EasyFix program.

If you cannot find the installation file on your computer, check the "downloads" folder or search for the file named "easyfix4-setup".

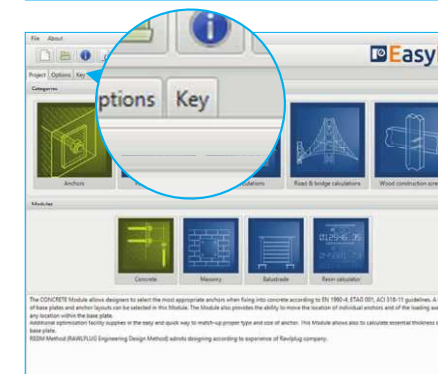

First run of the program

10 Starting up EasyFix software

Start the EasyFix program and go to the key tab to enter your key.

Remember that you need an active internet connection to verify the key.

Entering the key

11 Key EasyFix software

Enter the activation key and confirm changes.



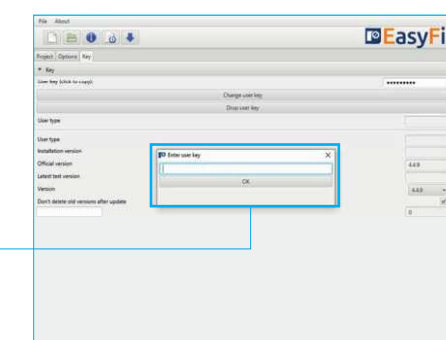



You can find the key in the e-mail or after logging in by the account tab on the website www.easyfix.rawlplug.com.



BASICS OF ANCHORING - TERMINOLOGY & SYMBOLS ▾

The notations and symbols frequently used in catalogues are given below. Further notations are given in the text.

APPROVALS AND CERTIFICATES SYMBOLS

	European Technical Approval / European Technical Assessment (ETA)
	CE marking (conformity with ETA or harmonised standard)
	Polish Construction Sign
	Resistance to fire exposure
	Factory Mutual Research Corporation (FM) approved
	Earthquake Resistant

INDICES

c	Concrete
cp	Concrete pry-out
d	Design value
k	Characteristic value
M	Material
p	Pull-out
R	Resistance
s	Steel
S	Action
sp	Splitting
u	Ultimate
y	Yield

LOADS

N	Normal force (positive: tension load, negative: compression load)
N_{Rk}	Characteristic value of resistance of a single anchor or an anchor group (tension load)
N_{Rk,p}	Characteristic resistance in case of failure by pull-out (tension load)
N_{Rk,c}	Characteristic resistance in case of concrete cone failure (tension load)
N_{Rk,s}	Characteristic resistance of an anchor in case of steel failure (tension load)
N_{Rd}	Design value of resistance of a single anchor or an anchor group (tension load)
N_{Rd,p}	Design resistance of an anchor in case of failure by pull-out (tension load)
N_{Rd,c}	Design resistance for an anchor or an group of anchors in the case of concrete cone failure (tension load)
N_{Rd,s}	Design resistance of an anchor in case of steel failure (tension load)
V	Shear force
V_{Rk}	Characteristic resistance of a single anchor or an anchor group (shear load)
V_{Rk,c}	Characteristic resistance in case of concrete edge failure (shear load)
V_{Rk,cp}	Characteristic resistance in case of failure by pry-out (shear load)
V_{Rk,s}	Characteristic resistance in case of steel failure (shear load)
V_{Rd}	Design resistance of a single anchor or an anchor group (shear load)

BASICS OF ANCHORING - TERMINOLOGY & SYMBOLS ▾

V_{Rd,c}	Design resistance in case of concrete edge failure (shear load)
V_{Rd,cp}	Design resistance of an anchor in case of failure by pry-out (shear load)
V_{Rd,s}	Design resistance in case of steel failure (shear load)

SAFETY FACTORS

γ_{Mc}	Partial safety factor for concrete cone failure
γ_{Ms}	Partial safety factor for steel failure

CONCRETE AND STEEL (MECHANICAL PROPERTIES)

f_{yk}	Characteristic steel yield strength (nominal value)
f_{uk}	Characteristic steel ultimate tensile strength (nominal value)
A_s	Stressed cross-sectional area of steel
W_{el}	Elastic section modulus calculated from the stressed cross-sectional area of steel
M^o_{Rk,s}	Characteristic bending resistance of an individual anchor
M	Allowable bending moment

CHARACTERISTIC VALUES OF ANCHORS

c	Edge distance
c_N	Edge distance (tensile resistance)
c_V	Edge distance (shear resistance)
c_{cr}	Edge distance for ensuring the transmission of the characteristic resistance
c_{cr,N}	Edge distance for ensuring the transmission of the characteristic tensile resistance of a single anchor without spacing and edge effects
c_{cr,V}	Edge distance for ensuring the transmission of the characteristic shear resistance of a single anchor without spacing and edge effects
c_{min}	Minimum allowable edge distance
d	Diameter of anchor bolt or thread diameter
d_f	Drill hole diameter in fixture
d_o	Drill hole diameter in substrate
h	Thickness of substrate
h_{min}	Minimum thickness of substrate
h_{ef}	Effective anchorage depth
h_{nom}	Embedment depth
h_o	Minimum drilled hole depth
k	Factor to be taken from the relevant ETA (pry-out failure)
L	Anchor length
s	Spacing of anchors in a group
s_{cr}	Spacing for ensuring the transmission of the characteristic resistance
s_{min}	Minimum allowable spacing
s_{cr,N}	Spacing for ensuring the transmission of the characteristic tensile resistance of a single anchor without spacing and edge effects
t_{fix}	Fixture thickness
T_{inst}	Installation torque



Bonded Anchors

THREADED RODS	R-KEX-II with Threaded Rods	82
	R-KEX-I with Threaded Rods	89
	R-KER-II R-CFS+KER-II with Threaded Rods	95
	R-CAS-V Spin-In Capsule with Threaded Rods	102
	R-HAC-V Hammer-In Capsule with Threaded Rods	106
	R-KEM-II RM50 with Threaded Rods for Concrete	110
SOCKETS	R-KEX-II with Sockets	116
	R-KER-II R-CFS+KER-II Hybrid resin with Sockets	120
REBAR	R-KEX-II with Rebar as an Anchor	126
	R-KEX-I with Rebar as an Anchor	132
	R-KER-II R-CFS+KER-II with Rebar as an Anchor	137
POST-INSTALLED REBAR	R-HAC-V Hammer-In Capsule with Rebar	143
	R-KEX-II with Post-installed rebar	147
	R-KEX-I with Post-installed rebar	156
MASONRY	R-KER-II-S R-CFS+KER-II-S with Post-installed rebar	164
	R-KEM-II RM50 with Threaded Rods for Masonry	171
	Accessories	176

OVERVIEW OF OUR RANGE - BONDED ANCHOR SELECTOR



BONDED ANCHOR SYSTEM:		R-KEX-II with threaded rods	R-KEX-II with ITS	R-KEX-II with rebar as an anchor	R-KEX-II with post- installed rebar	R-KEX-I with threaded rods	R-KEX-I with rebar as an anchor
ANCHOR MATERIAL	5.8 STEEL CLASS, ZINC PLATED	☑	-	-	-	☑	-
	8.8 STEEL CLASS, ZINC PLATED	☑	-	-	-	☑	-
	STAINLESS STEEL	☑	-	-	-	☑	-
	REBAR	-	-	☑	☑	-	☑
	R-ITS	-	☑	-	-	-	-
SUBSTRATES	CONCRETE	☑	☑	☑	☑	☑	☑
	CRACKED CONCRETE	☑	-	☑	☑	☑	☑
	SILICATE BRICK	-	-	-	-	-	-
	SOLID BRICK	-	-	-	-	-	-
	HOLLOW BRICK	-	-	-	-	-	-
	LIGHTWEIGHT CONCRETE BLOCKS	-	-	-	-	-	-
APPROVALS	ETA CE	☑ Option 1	☑ Option 7	☑ Option 1	☑ ETA	☑ Option 1	☑ Option 1
	UB	-	-	-	☑	-	-
	ustac	☑	-	☑	☑	-	-
	POLISH ROADS AND BRIDGES CONSTRUCTION INSTITUTE	☑	☑	☑	☑	-	-
TENSION LOADS IN kN	[kN]	N _{Rd}	N _{Rd}	N _{Rd}	N _{Rd}	N _{Rd}	N _{Rd}
	10	M8 for 5.8	M6 for 5.8	Ø8 for A-II	Ø8 for A-II	M8 for 5.8	Ø8 for A-II
	20						
	30						
	40		M16				
	50						
	60						
	70						
	80						
	90						
	100						
	110						
	120						
	130						
	140						
150							
160							
170			Ø32	Ø32		Ø32	
180							
190							
200							
210							
220							
230		M30				M30	

OVERVIEW OF OUR RANGE - BONDED ANCHOR SELECTOR



R-KEX-I with post- installed rebar	R-KER-II R-CFS+KER-II with threaded rods	R-KER-II R-CFS+KER-II with ITS	R-KER-II R-CFS+KER-II with rebar as an anchor	R-KER-II-S R-CFS+KER-II-S with post-installed rebar	R-KEM II CFS+RM-50 in concrete	R-KEM II CFS+RM-50 in masonry
-	☑	-	-	-	☑	☑
-	☑	-	-	-	☑	☑
-	☑	-	-	-	☑	☑
☑	-	-	☑	☑	-	-
-	-	☑	-	-	-	-
☑	☑	☑	☑	☑	☑	-
☑	☑	☑	☑	☑	-	-
-	-	-	-	-	-	☑
-	-	-	-	-	-	☑
-	-	-	-	-	-	☑
-	-	-	-	-	-	☑
☑ ETA	☑ Option 1	☑ Option 1	☑ Option 1	☑ ETA	☑ Option 7	☑ 001
-	☑	☑	☑	☑	-	-
-	☑	-	-	-	-	-
-	☑	☑	☑	☑	☑	☑
N _{Rd}	N _{Rd}	N _{Rd}	N _{Rd}	N _{Rd}	N _{Rd}	N _{Rd}
Ø8 for A-II	M8 for 5.8	M6 for 5.8	Ø8 for A-II	Ø8 for A-II	M8 for 5.8	M8-M16 for 5.8
		M16				
					M30	
	M30					
Ø32			Ø32			
				Ø40		

OVERVIEW OF OUR RANGE - BONDED ANCHOR SELECTOR

BONDED ANCHOR SYSTEM:		R-CAS-V with threaded rods	R-HAC-V with threaded rods	R-HAC-V with rebar as an anchor
ANCHOR MATERIAL	5.8 STEEL CLASS, ZINC PLATED	☑	☑	-
	8.8 STEEL CLASS, ZINC PLATED	☑	☑	-
	STAINLESS STEEL	☑	☑	-
	REBAR	-	-	☑
	R-ITS	-	-	-
SUBSTRATES	CONCRETE	☑	☑	☑
	CRACKED CONCRETE	-	-	-
	SILICATE BRICK	-	-	-
	SOLID BRICK	-	-	-
	HOLLOW BRICK	-	-	-
	LIGHTWEIGHT CONCRETE BLOCKS	-	-	-
APPROVALS	ETA CE	☑ Option 7	☑ Option 7	☑ Option 7
	CE	-	-	-
	CE	-	-	-
	POLISH ROADS AND BRIDGES CONSTRUCTION INSTITUTE	☑	☑	☑
TENSION LOADS IN kN	[kN]	N_{rd}	N_{rd}	N_{rd}
	10	M8 For 5.8	M8 For 5.8	Ø8 For 5.8
	20			
	30			
	40			
	50			Ø25
	60			
	70			
	80			
	90		M30	
	100			
	110	M30		
	120			
	130			
	140			
	150			
	160			
	170			
	180			
	190			
	200			
210				
220				
230				

OVERVIEW OF OUR RANGE - BONDED ANCHOR SELECTOR

BONDED ANCHORS - RESIN TYPES

PURE EPOXY	HYBRID VINYLESTER	POLYESTER STYRENE FREE	POLYESTER
<ul style="list-style-type: none"> » Most suitable for construction, as well as for deep anchorages. » Designed for heavy-duty anchorages in cracked and non-cracked concrete. » Suitable for use in dry and wet substrates as well as holes and substrates covered with water. 	<ul style="list-style-type: none"> » Most common product for construction. » Intended for medium and heavy-duty anchorages in cracked and non-cracked concrete. » Suitable for use in low temperatures (down to -20° for winter option) enables use throughout the year. » Suitable for use in dry and wet substrates as well as holes and substrates covered with water. 	<ul style="list-style-type: none"> » The most contemporary general use bonded anchor. » Intended for medium duty fixings in 15 types of substrate. » Low odour suitable for indoor applications. » Product with wide spectrum of use in the medium load capacity area. 	<ul style="list-style-type: none"> » Suitable for medium-duty fixings in non-cracked concrete.





BONDED ANCHORS ARE OFFERED IN A WIDE RANGE OF SYSTEMS

GLASS CAPSULES	CARTRIDGES	FOILS
<p>Glass capsules containing both the resin and hardener, which mix and set after the stud or socket is driven in to the hole.</p> 	<p>Tubular plastic cartridges containing resin. Various formats depending on resin components, which are kept separate within cartridge until delivered via mixer nozzle.</p> <ul style="list-style-type: none"> » foil cartridge system CHUBAPAC » coaxial cartridge system COX » cartridge system side by side SBS 	<p>CFS+ (Cartridge Free System) Innovative resin dispensing system with unique packaging solution, which reduces overall waste. Resin components contained separately within foil until delivered via mixer nozzle.</p> 

FEATURES & BENEFITS OF DELIVERY SYSTEMS

<ul style="list-style-type: none"> » Quick and easy to install » Only solid substrates » Minimal packaging waste - Whole capsule installed in hole » No waste resin » No special tools required » No time limitations - Resin only begins to set after stud, rod or rebar is inserted 	<ul style="list-style-type: none"> » For all substrates, including deep anchorages » Many applications from one cartridge » Ability to resume use after stoppages » Small cartridges are compatible with standard, low-cost silicone guns » Simple to store and transport 	<ul style="list-style-type: none"> » For all substrates, including deep anchorages » Easy to dispense » Less waste - Recyclable packaging » The cost-effective solution for many customers
---	--	--

RESIN PRODUCTS AVAILABLE IN EACH SYSTEM

VINYLESTER: R-HAC-V, R-CAS-V	PURE EPOXY: R-KEX II HYBRID VINYLESTER: R-KER-II POLYESTER: R-KEM II, R-KF2	POLYESTER: RM50, RP30 VINYLESTER: RV200
------------------------------	---	--

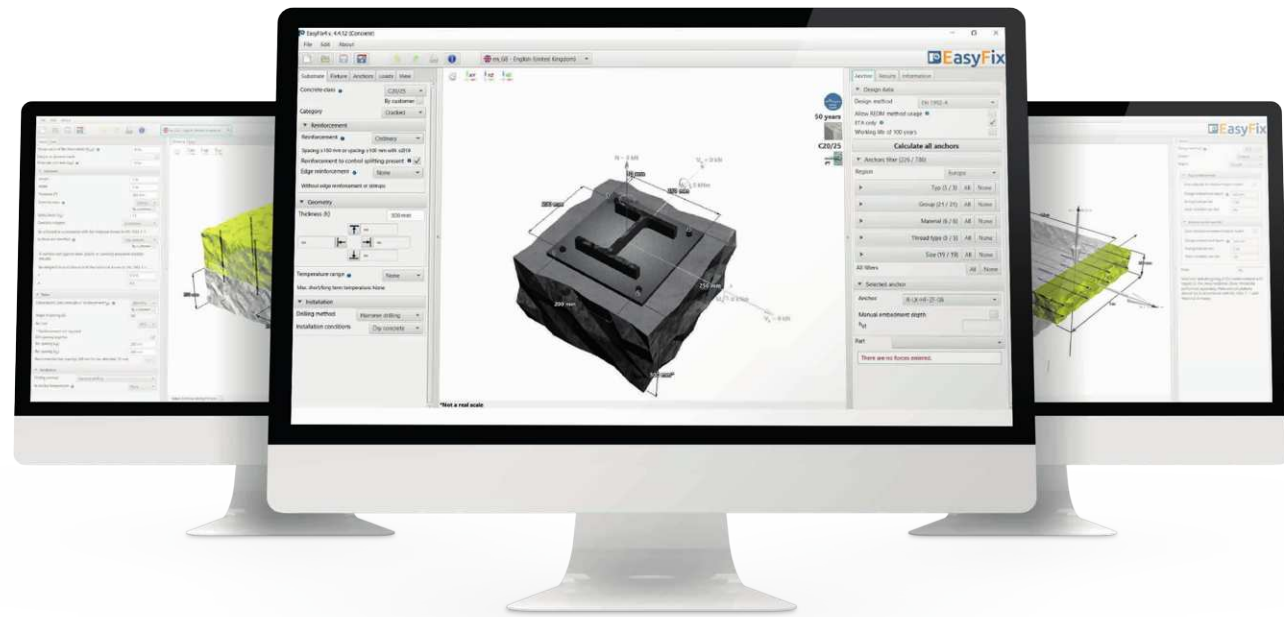

CONCRETE MODULE



The filters and optimisation functions make it possible to choose the right type and size of fixing in a simple and quick way.

The module also makes it possible to calculate the required thickness of the slab.

A wide range of options for placing the fasteners on the element to be fixed is available. Option of using the original REDM (Rawplug Engineering Design Method) based on the many years of experience of RAWPLUG's engineers and on European guidelines. This makes it possible to design more complex anchoring systems.

Possibility of entering design loads, characteristic loads with region-specific safety factors, seismic and fire loads.

Possibility of designing according to different calculation standards, US and European ones (e.g. EN, ETAG, ACI) and Rawplug's original method. This allows the calculations to be adjusted to the needs and legal requirements of all global markets. Australian and Russian standards are planned to be included in the program.



BALUSTRADE MODULE



Makes it possible to design fixings intended for concrete substrates.

Includes diagrams that match the systems used when installing safety barriers.

The module makes use of a simplified model for entering load parameters.

They are assumed on the basis of the guidelines laid down in the EN 1991-1-1 standard which recommends the range of characteristic loads for different use categories.

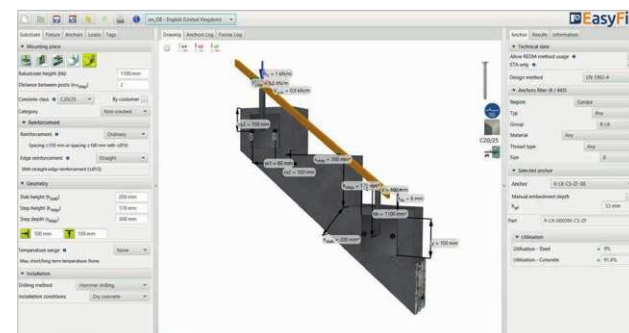

MASONRY MODULE



Includes the possibility of designing in masonry substrates made of materials classified in groups B, C and D according to ETAG 020 and ETAG 029.

Makes it possible to define substrates at the user's discretion.

Makes it possible to use different brick layouts, so that designs can be made for new structures and for renovation of existing ones.

The filters and optimisation functions make it possible to choose the right type and size of fixing in a simple and quick way.

Possibility of entering design loads and characteristic loads, with region-specific safety factors.

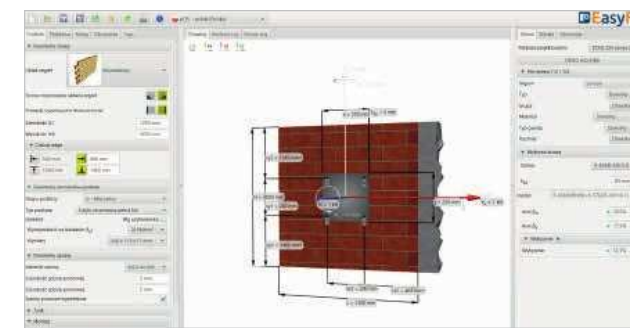

CONCRETE INTERFACE REINFORCEMENT MODULE

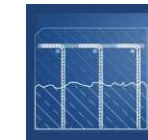

The task of the module is to calculate the reinforcement that bonds concrete elements cast at different times

The calculation basis is the EN 1992-1-1 standard.

The module offers the possibility of performing different calculation variants:

- calculation of the bar spacing for the set bar diameter;
- calculation of the bar diameter for the set bar grid spacing;
- testing connection strength for the set bar diameter and spacing.

Information is also provided on the amount of resin required for all the fixings.

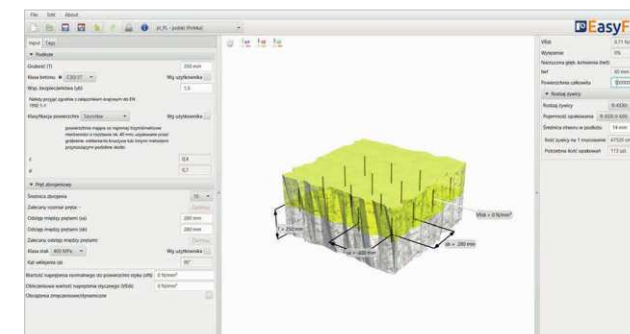

REBAR MODULE

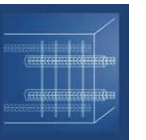

Designing post-installed rebar anchoring in concrete substrates. Simple and user-friendly designing process for reinforcement continuity in accordance with the EUROCODE 2 guidelines.

Offers a number of different combinations for the installation of existing or new reinforcement elements, depending on the user's needs, as well as the possibility of defining the existing reinforcement.

An important function involves the calculation of internal forces in cross-sections of existing rebars and post-installed rebars.

It is also possible to enter loads for a single bar, for the structure cross-section or to calculate the maximum forces transmitted by the joint taking into account the steel strength.

The wide range of existing steel and concrete grades and the possibility of defining the user's own data make this module open up virtually unlimited design opportunities.

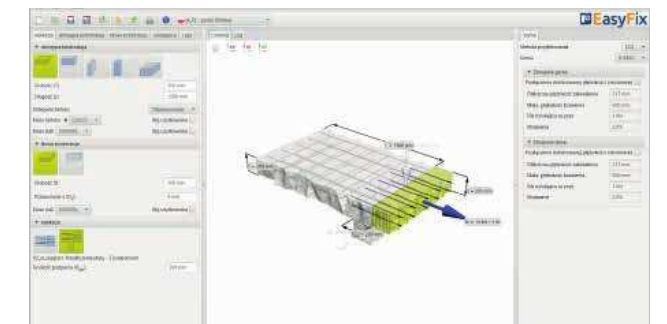

PLINTH ANCHOR MODULE



This module makes it possible to calculate and select the element connecting the bridge deck overhang to the bridge load-carrying structure.

The procedure is based on EN 40-3-1, EN 1991-2, EN 1991-1-4. You can choose an overhang with a fascia panel or with a solid edge beam.

Different barrier systems can be taken into account in the design of the fixings.

Anchor placement in one or two rows.

Possibility of taking into account the impact of lampposts and noise barriers fixed to the plinth.

The filters and optimisation functions make it possible to choose the right type and size of fixing in a simple and quick way.



R-KEX-II WITH THREADED RODS

Premium pure epoxy resin approved for use in cracked and non-cracked concrete



FEATURES AND BENEFITS

- Seismic category C1 and C2
- Installation direction D3 (downward and horizontal and upwards installation)
- Diamond and hammer drilling
- Approved for use with threaded rods for use in cracked and non-cracked concrete (EAD 330499-00-0601)
- The strongest resin in the epoxy resin class
- Suitable for use in dry and wet substrates including flooded holes (use category I1 & I2)
- Minimal shrinkage provides option of use in diamond-drilled holes and oversized holes
- Very high chemical resistance – suitable for applications exposed to influence of various agents (industrial or marine environment)
- Extended working time ensures easy installation of metal components (up to 30 min. in 20°C)
- For use in positive temperatures

APPLICATIONS

- Safety barriers
- Formwork support systems
- Structural steelwork
- Street lamps
- Curtain walling
- Racking systems
- Balustrading
- Barriers
- Cladding restraints
- Masonry support
- Heavy machinery
- Platforms

BASE MATERIALS

- Approved for use in:
- Cracked concrete C20/25-C50/60
 - Non-cracked concrete C20/25-C50/60

INSTALLATION GUIDE

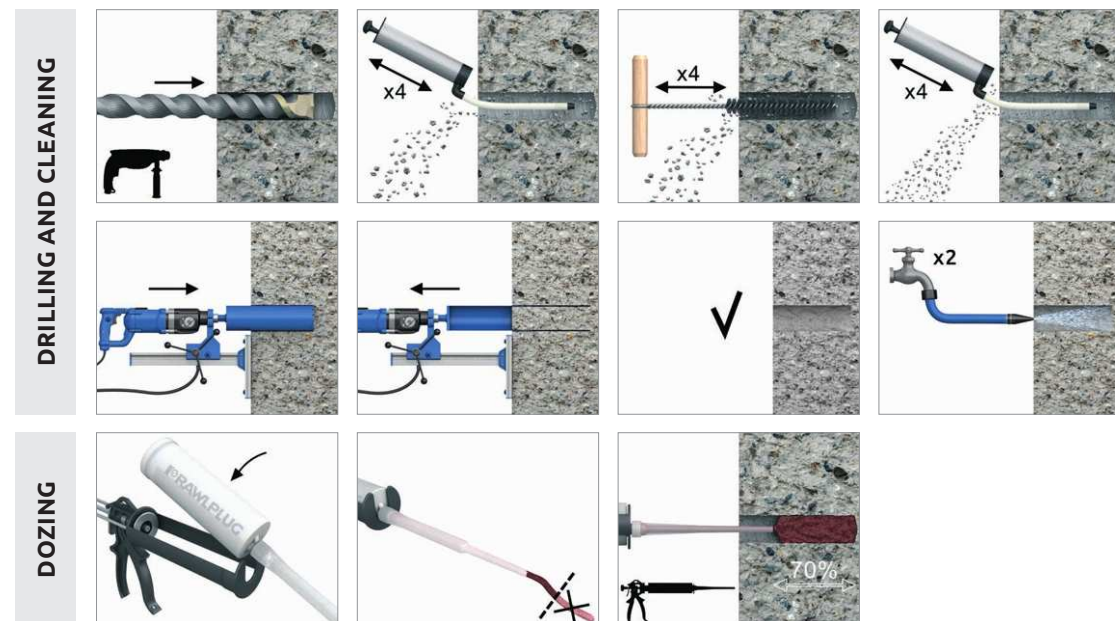

R-KEX-II WITH THREADED RODS

INSTALLATION GUIDE (cont.)

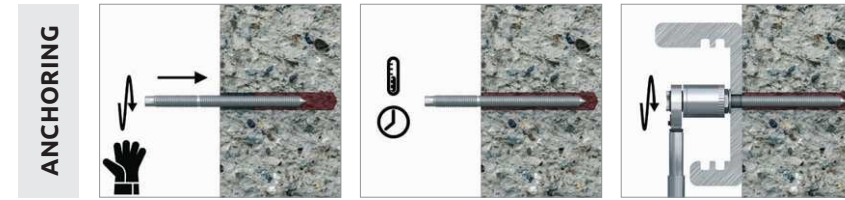

- Drill hole to the required diameter and depth for stud size being used.
- Clean the hole thoroughly with brush and hand pump at least four times before installation.
- Insert cartridge into gun and attach nozzle.
- Dispense to waste until even colour is obtained.
- Insert the mixer nozzle to the bottom of the drill hole and inject resin, slowly withdrawing the nozzle as the hole is filled to 70% of its depth.
- Immediately insert the stud, slowly and with slight twisting motion. Remove any excess resin around the hole before it sets and leave it undisturbed until the curing time elapses.
- Attach fixture and tighten the nut to the required torque.

PRODUCT INFORMATION

Product Code	Resin	Description / Resin Type	Volume
			[ml]
R-KEX-II-385	R-KEX II	Epoxy Resin	385
R-KEX-II-600			600

R-STUDS

Size	Product Code			Anchor		Fixture		
	Steel class 5.8	Steel class 8.8	Steel grade A4	Diameter	Length	Hole diameter	Max. thickness t _{fix} for:	
				d	L	d _f	h _{nom, 12d}	h _{nom, 12d}
				[mm]	[mm]	[mm]	[mm]	[mm]
M8	R-STUDS-08110	R-STUDS-08110-88	R-STUDS-08110-A4	8	110	9	4	4
	R-STUDS-08160	-	R-STUDS-08160-A4	8	160	9	57	57
M10	R-STUDS-10130	R-STUDS-10130-88	R-STUDS-10130-A4	10	130	12	-	-
	R-STUDS-10170	-	-	10	170	12	38	38
	R-STUDS-10190	-	-	10	190	12	58	58
M12	R-STUDS-12160	R-STUDS-12160-88	R-STUDS-12160-A4	12	160	14	1	1
	R-STUDS-12190	-	R-STUDS-12190-A4	12	190	14	31	31
	R-STUDS-12220	-	-	12	220	14	61	-
	R-STUDS-12260	-	-	12	260	14	101	101
	R-STUDS-12300	R-STUDS-12300-88	R-STUDS-12300-A4	12	300	14	141	141
M16	R-STUDS-16190	R-STUDS-16190-88	R-STUDS-16190-A4	16	190	18	-	-
	R-STUDS-16220	R-STUDS-16220-88	-	16	220	18	9	9
	R-STUDS-16260	-	-	16	260	18	49	49
	R-STUDS-16300	-	-	16	300	18	89	89
				16	380	18	169	169
M20		R-STUDS-20220-88						
	R-STUDS-20260	R-STUDS-20260-88	R-STUDS-20260-A4	20	260	22	-	-
	R-STUDS-20300	R-STUDS-20300-88	-	20	300	22	37	37
				20	350	22	87	87
M24	R-STUDS-24300	R-STUDS-24300-88	R-STUDS-24300-A4	24	300	26		
M30	R-STUDS-30380	R-STUDS-30380-88	-	30	380	32		

R-KEX-II WITH THREADED RODS

INSTALLATION DATA

R-STUDS

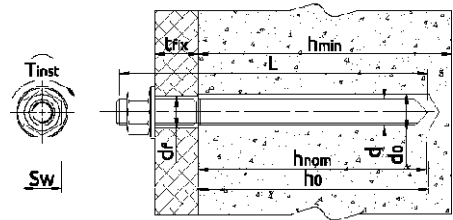

Size	M8	M10	M12	M16	M20	M24	M30		
Thread diameter	d	[mm]	8	10	12	16	20	24	30
Hole diameter in substrate	d _o	[mm]	10	12	14	18	24	28	35
Hole diameter in fixture	d _f	[mm]	9	12	14	18	22	26	32
Min. hole depth in substrate	h _o	[mm]	h _{nom} + 5	h _{nom} + 5	h _{nom} + 5	h _{nom} + 5	h _{nom} + 5	h _{nom} + 5	h _{nom} + 5
Min. substrate thickness	h _{min}	[mm]	h _{nom} + 30 ≥ 100	h _{nom} + 30 ≥ 100	h _{nom} + 30 ≥ 100	h _{nom} + 2d _o	h _{nom} + 2d _o	h _{nom} + 2d _o	h _{nom} + 2d _o
Installation torque	T _{inst}	[Nm]	10	20	40	80	120	180	200
Min. spacing	S _{min}	[mm]	40	40	40	50	60	70	85
Min. edge distance	c _{min}	[mm]	40	40	40	50	60	70	85
MINIMUM EMBEDMENT DEPTH									
Min. installation depth	h _{nom,min}	[mm]	60	70	80	100	120	140	165
MAXIMUM EMBEDMENT DEPTH									
Min. installation depth	h _{nom,max}	[mm]	160	200	240	320	400	480	600

Minimum working and curing time

Resin temperature	Concrete temperature	Curing time*	Working time
[°C]	[°C]	[min]	[min]
5	5	2880	150
10	10	1080	120
20	20	480	35
25	30	300	12

* For wet concrete the curing time must be doubled

MECHANICAL PROPERTIES

Size	M8	M10	M12	M16	M20	M24	M30
R-STUDS Metric Threaded Rods - Steel Class 5.8							
Nominal ultimate tensile strength - tension	F _{uk}	[N/mm ²]	500	500	500	500	500
Nominal yield strength - tension	F _{yk}	[N/mm ²]	400	400	400	400	400
Cross sectional area - tension	A _s	[mm ²]	36.6	58	84.3	157	245
Elastic section modulus	W _{el}	[mm ³]	31.2	62.3	109.2	277.5	541
Characteristic bending resistance	M ⁰ _{Rk,s}	[Nm]	19	37	65	166	324
Design bending resistance	M	[Nm]	15	30	52	133	259
Allowable bending resistance	M _{rec}	[Nm]	11	21	37	95	185
R-STUDS Metric Threaded Rods - Steel Class 8.8							
Nominal ultimate tensile strength - tension	F _{uk}	[N/mm ²]	800	800	800	800	800
Nominal yield strength - tension	F _{yk}	[N/mm ²]	640	640	640	640	640
Cross sectional area - tension	A _s	[mm ²]	36.6	58	84.3	157	245
Elastic section modulus	W _{el}	[mm ³]	31.2	62.3	109.2	277.5	541
Characteristic bending resistance	M ⁰ _{Rk,s}	[Nm]	30	60	105	266	519
Design bending resistance	M	[Nm]	24	48	84	213	416
Allowable bending resistance	M _{rec}	[Nm]	17	34	60	152	297
R-STUDS Metric Threaded Rods - A4							
Nominal ultimate tensile strength - tension	F _{uk}	[N/mm ²]	700	700	700	700	700
Nominal yield strength - tension	F _{yk}	[N/mm ²]	450	450	450	450	450
Cross sectional area - tension	A _s	[mm ²]	36.6	58	84.3	157	245
Elastic section modulus	W _{el}	[mm ³]	31.2	62.3	109.2	277.5	541
Characteristic bending resistance	M ⁰ _{Rk,s}	[Nm]	26	52	92	233	454
Design bending resistance	M	[Nm]	17	34	59	149	291
Allowable bending resistance	M _{rec}	[Nm]	12	24	42	107	208

R-KEX-II WITH THREADED RODS

BASIC PERFORMANCE DATA

R-STUDS

Performance data for single anchor without influence of edge distance and spacing

Size	M8	M10	M12	M16	M20	M24	M30	M8	M10	M12	M16	M20	M24	M30
Substrate	Non-cracked concrete							Cracked concrete						
MEAN ULTIMATE LOAD														
TENSION LOAD N_{Ru,m}														
R-STUDS METRIC THREADED RODS - STEEL CLASS 5.8														
Minimum embedment depth	[kN]	18.90	30.45	44.10	67.50	88.73	111.81	143.06	18.90	27.82	33.99	47.50	62.44	76.68
Maximum embedment depth	[kN]	18.90	30.45	44.10	81.90	128.10	184.80	294.00	18.90	30.45	44.10	81.90	128.10	184.80
R-STUDS METRIC THREADED RODS - STEEL CLASS 8.8														
Minimum embedment depth	[kN]	28.65	39.53	48.33	67.50	88.73	111.81	143.06	22.08	27.82	33.99	47.50	62.44	76.68
Maximum embedment depth	[kN]	30.45	48.30	70.35	132.30	205.80	296.10	471.05	30.45	48.30	70.35	132.30	205.80	296.10
R-STUDS METRIC THREADED RODS - A4														
Minimum embedment depth	[kN]	27.30	39.53	48.30	67.05	88.73	111.81	143.06	22.08	27.82	33.99	47.50	62.44	76.68
Maximum embedment depth	[kN]	27.30	43.05	61.95	115.50	179.55	259.35	412.65	27.30	43.05	61.95	115.50	179.55	259.35
SHEAR LOAD V_{Ru,m}														
R-STUDS METRIC THREADED RODS - STEEL CLASS 5.8														
Minimum embedment depth	[kN]	11.34	18.27	26.46	49.14	76.86	110.88	176.40	11.34	18.27	26.46	49.14	76.86	110.88
Maximum embedment depth	[kN]	11.34	18.27	26.46	49.14	76.86	110.88	176.40	11.34	18.27	26.46	49.14	76.86	110.88
R-STUDS METRIC THREADED RODS - STEEL CLASS 8.8														
Minimum embedment depth	[kN]	18.27	28.98	42.21	79.38	123.48	177.66	282.87	18.27	28.98	42.21	79.38	123.48	177.66
Maximum embedment depth	[kN]	18.27	28.98	42.21	79.38	123.48	177.66	282.87	18.27	28.98	42.21	79.38	123.48	177.66
R-STUDS METRIC THREADED RODS - A4														
Minimum embedment depth	[kN]	16.38	16.38	37.17	69.30	107.73	155.61	247.59	16.38	25.83	31.17	69.30	107.73	155.61
Maximum embedment depth	[kN]	16.38	16.38	37.17	69.30	107.73	155.61	247.59	16.38	25.83	31.17	69.30	107.73	155.61
CHARACTERISTIC LOAD														
TENSION LOAD N_{Rk}														
R-STUDS METRIC THREADED RODS - STEEL CLASS 5.8														
Minimum embedment depth	[kN]	18.00	28.81	35.20	49.19	64.67	81.49	104.26	12.06	17.59	21.11	34.44	45.27	57.04
Maximum embedment depth	[kN]	18.00	29.00	42.00	78.00	122.00	176.00	280.00	18.00	29.00	42.00	78.00	122.00	176.00
R-STUDS METRIC THREADED RODS - STEEL CLASS 8.8														
Minimum embedment depth	[kN]	22.86	28.81	35.20	49.19	64.67	81.49	104.26	12.06	17.59	21.11	34.44	45.27	57.04
Maximum embedment depth	[kN]	29.00	46.00	67.00	126.00	196.00	282.00	449.00	29.00	46.00	63.33	112.59	175.93	217.15
R-STUDS METRIC THREADED RODS - A4														
Minimum embedment depth	[kN]	22.86	28.81	35.20	49.19	64.67	81.49	104.26	12.06	17.59	21.11	34.44	45.27	57.04
Maximum embedment depth	[kN]	26.00	41.00	59.00	110.00	171.00	247.00	393.00	26.00	41.00	59.00	110.00	171.00	217.15
SHEAR LOAD V_{Rk}														
R-STUDS METRIC THREADED RODS - STEEL CLASS 5.8														
Minimum embedment depth	[kN]	9.00	14.00	21.00	39.00	61.00	88.00	140.00	9.00	14.00	21.00	39.00	61.00	88.00
Maximum embedment depth	[kN]	9.00	14.00	21.00	39.00	61.00	88.00	140.00	9.00	14.00	21.00	39.00	61.00	88.00
R-STUDS METRIC THREADED RODS - STEEL CLASS 8.8														
Minimum embedment depth	[kN]	15.00	23.00	34.00	63.00	98.00	141.00	208.53	15.00	23.00	34.00	63.00	90.53	114.08
Maximum embedment depth	[kN]	15.00	23.00	34.00	63.00	98.00	141.00	224.00	15.00	23.00	34.00	63.00	90.53	114.08
R-STUDS METRIC THREADED RODS - A4														
Minimum embedment depth	[kN]	13.00	20.00	29.00	55.00	86.00	124.00	196.00	13.00	20.00	29.00	55.00	86.00	114.08
Maximum embedment depth	[kN]	13.00	20.00	29.00	55.00	86.00	124.00	196.00	13.00	20.00	29.00	55.00	86.00	124.00
DESIGN LOAD														
TENSION LOAD N_{Rd}														
R-STUDS METRIC THREADED RODS - STEEL CLASS 5.8														
Minimum embedment depth	[kN]	12.00	19.21	23.47	32.80	43.11	54.33	69.51	8.04	11.73	14.07	22.96	30.18	38.03
Maximum embedment depth	[kN]	12.00	19.33	28.00	52.00	81.33	117.33	186.67	12.00	19.33	28.00	52.00	81.33	117.33
R-STUDS METRIC THREADED RODS - STEEL CLASS 8.8														
Minimum embedment depth	[kN]	15.24	19.21	23.47	32.80	43.11	54.33	69.51	8.04	11.73	14.07	22.96	30.18	38.03
Maximum embedment depth	[kN]	19.33	30.67	44.67	84.00	130.67	188.00	299.33	19.33	30.67	42.22	75.06	117.29	144.76
R-STUDS METRIC THREADED RODS - A4														
Minimum embedment depth	[kN]	13.90	19.21	23.47	32.80	43.11	54.33	69.51	8.04	11.73	14.07	22.96	30.18	38.03
Maximum embedment depth	[kN]	13.90	21.93	31.55	58.82	91.44	132.09	210.16	13.90	21.93	31.55	58.82	91.44	132.09

R-KEX-II WITH THREADED RODS

BASIC PERFORMANCE DATA (cont.)

Size	M8	M10	M12	M16	M20	M24	M30	M8	M10	M12	M16	M20	M24	M30	
SHEAR LOAD V_{Rd}															
R-STUDS METRIC THREADED RODS - STEEL CLASS 5.8															
Minimum embedment depth	[kN]	7.20	11.20	16.80	31.20	48.80	70.40	112.00	7.20	11.20	16.80	31.20	48.80	70.40	112.00
Maximum embedment depth	[kN]	7.20	11.20	16.80	31.20	48.80	70.40	112.00	7.20	11.20	16.80	31.20	48.80	70.40	112.00
R-STUDS METRIC THREADED RODS - STEEL CLASS 8.8															
Minimum embedment depth	[kN]	12.00	18.40	27.20	50.40	78.40	108.65	139.02	12.00	18.40	27.20	50.40	78.40	112.80	179.20
Maximum embedment depth	[kN]	12.00	18.40	27.20	50.40	78.40	112.80	179.20	12.00	18.40	27.20	50.40	78.40	112.80	179.20
R-STUDS METRIC THREADED RODS - A4															
Minimum embedment depth	[kN]	8.33	12.82	18.59	35.26	55.13	79.49	125.64	8.33	12.82	18.59	35.26	55.13	76.06	97.31
Maximum embedment depth	[kN]	8.33	12.82	18.59	35.26	55.13	79.49	125.64	8.33	12.82	18.59	35.26	55.13	79.49	125.64
RECOMMENDED LOAD															
TENSION LOAD N_{rec}															
R-STUDS METRIC THREADED RODS - STEEL CLASS 5.8															
Minimum embedment depth	[kN]	8.57	13.72	16.67	23.43	30.79	38.80	49.65	5.74	8.38	10.05	16.40	21.56	27.16	34.75
Maximum embedment depth	[kN]	8.57	13.81	20.00	37.14	58.10	83.81	133.33	8.57	13.81	20.00	37.14	58.10	83.81	133.33
R-STUDS METRIC THREADED RODS - STEEL CLASS 8.8															
Minimum embedment depth	[kN]	8.57	13.72	16.67	23.43	30.79	38.80	49.65	5.74	8.38	10.05	16.40	21.56	27.16	34.75
Maximum embedment depth	[kN]	13.81	21.90	31.90	60.00	93.33	134.29	213.81	13.81	21.90	30.16	55.62	83.78	103.40	134.64
R-STUDS METRIC THREADED RODS - A4															
Minimum embedment depth	[kN]	9.93	13.72	16.76	23.43	30.79	38.80	49.65	5.74	8.38	10.05	16.40	21.56	27.16	34.75
Maximum embedment depth	[kN]	9.93	15.66	22.54	42.02	65.32	94.35	150.11	9.93	15.66	22.54	42.02	65.32	94.35	134.64
SHEAR LOAD V_{rec}															
R-STUDS METRIC THREADED RODS - STEEL CLASS 5.8															
Minimum embedment depth	[kN]	5.14	8.00	12.00	22.29	34.86	50.29	80.00	5.14	8.00	12.00	22.29	34.86	50.29	69.51
Maximum embedment depth	[kN]	5.14	8.00	12.00	22.29	34.86	50.29	80.00	5.14	8.00	12.00	22.29	34.86	50.29	80.00
R-STUDS METRIC THREADED RODS - STEEL CLASS 8.8															
Minimum embedment depth	[kN]	8.57	13.14	19.43	36.00	56.00	77.61	99.30	8.57	13.14	19.43	32.80	43.11	54.33	69.51
Maximum embedment depth	[kN]	8.57	13.14	19.43	36.00	56.00	80.57	128.00	8.57	13.14	19.43	36.00	56.00	80.57	128.00
R-STUDS METRIC THREADED RODS - A4															
Minimum embedment depth	[kN]	5.95	9.16	13.28	25.18	39.38	56.78	89.74	5.95	9.16	13.28	25.18	39.38	54.33	69.51
Maximum embedment depth	[kN]	5.95	9.16	13.28	25.18	39.38	56.78	89.74	5.95	9.16	13.28	25.18	39.38	54.33	89.74

DESIGN PERFORMANCE DATA

R-STUDS

Size	M8	M10	M12	M16	M20	M24	M30		
TENSION LOAD									
STEEL FAILURE; STEEL CLASS 5.8									
Characteristic resistance	$N_{Rk,s}$	[kN]	18.00	29.00	42.00	78.00	122.00	176.00	280.00
Partial safety factor	γ_{Ms}	-	1.50	1.50	1.50	1.50	1.50	1.50	1.50
STEEL FAILURE; STEEL CLASS 8.8									
Characteristic resistance	$N_{Rk,s}$	[kN]	29.00	46.00	67.00	126.00	196.00	282.00	448.00
Partial safety factor	γ_{Ms}	-	1.50	1.50	1.50	1.50	1.50	1.50	1.50
STEEL FAILURE; STEEL GRADE A4-70									
Characteristic resistance	$N_{Rk,s}$	[kN]	26.00	41.00	59.00	110.00	171.00	247.00	392.00
Partial safety factor	γ_{Ms}	-	1.87	1.87	1.87	1.87	1.87	1.87	1.87
WORKING LIFE 50 YEARS									
COMBINED PULL-OUT AND CONCRETE CONE FAILURE; NON-CRACKED CONCRETE, C20/25 (40°C/24°C)									
Characteristic bond resistance	T_{Rk}	[N/mm ²]	17.00	16.00	17.00	15.00	15.00	13.00	12.00
Sustained load factor	ψ_{sus}^0	-	0.75	0.75	0.75	0.75	0.75	0.75	0.75
COMBINED PULL-OUT AND CONCRETE CONE FAILURE; NON-CRACKED CONCRETE, C20/25 (80°C/50°C)									
Characteristic bond resistance	T_{Rk}	[N/mm ²]	15.00	14.00	15.00	13.00	13.00	12.00	10.00
Sustained load factor	ψ_{sus}^0	-	0.72	0.72	0.72	0.72	0.72	0.72	0.72
COMBINED PULL-OUT AND CONCRETE CONE FAILURE; CRACKED CONCRETE, C20/25 (40°C/24°C)									
Characteristic bond resistance	T_{Rk}	[N/mm ²]	8.00	8.00	7.00	7.00	7.00	6.00	5.00
Sustained load factor	ψ_{sus}^0	-	0.75	0.75	0.75	0.75	0.75	0.75	0.75
COMBINED PULL-OUT AND CONCRETE CONE FAILURE; CRACKED CONCRETE, C20/25 (80°C/50°C)									
Characteristic bond resistance	T_{Rk}	[N/mm ²]	7.00	7.00	6.00	6.00	6.00	5.00	4.00
Sustained load factor	ψ_{sus}^0	-	0.72	0.72	0.72	0.72	0.72	0.72	0.72

R-KEX-II WITH THREADED RODS

DESIGN PERFORMANCE DATA (cont.)

Size	M8	M10	M12	M16	M20	M24	M30		
WORKING LIFE 100 YEARS									
COMBINED PULL-OUT AND CONCRETE CONE FAILURE; NON-CRACKED CONCRETE, C20/25 (40°C/24°C)									
Characteristic bond resistance	T_{Rk}	[N/mm ²]	17.00	16.00	17.00	15.00	15.00	13.00	12.00
Sustained load factor	ψ_{sus}^0	-	0.6	0.6	0.6	0.6	0.6	0.6	0.6
COMBINED PULL-OUT AND CONCRETE CONE FAILURE; NON-CRACKED CONCRETE, C20/25 (80°C/50°C)									
Characteristic bond resistance	T_{Rk}	[N/mm ²]	15.00	14.00	15.00	13.00	13.00	12.00	10.00
Sustained load factor	ψ_{sus}^0	-	0.6	0.6	0.6	0.6	0.6	0.6	0.6
COMBINED PULL-OUT AND CONCRETE CONE FAILURE; CRACKED CONCRETE, C20/25 (40°C/24°C)									
Characteristic bond resistance	T_{Rk}	[N/mm ²]	8.00	8.00	6.50	7.00	7.00	6.00	5.00
Sustained load factor	ψ_{sus}^0	-	0.6	0.6	0.6	0.6	0.6	0.6	0.6
COMBINED PULL-OUT AND CONCRETE CONE FAILURE; CRACKED CONCRETE, C20/25 (80°C/50°C)									
Characteristic bond resistance	T_{Rk}	[N/mm ²]	6.5	7.00	6.00	6.00	6.00	5.00	4.00
Sustained load factor	ψ_{sus}^0	-	0.6	0.6	0.6	0.6	0.6	0.6	0.6
TENSION LOAD									
COMBINED PULL-OUT AND CONCRETE CONE FAILURE									
Installation safety factor	γ_2	-	1.00	1.00	1.00	1.00	1.00	1.00	1.00
Increasing factors for $N_{Rk,p}$ - C30/37	ψ_c	-	1.04	1.04	1.04	1.04	1.04	1.04	1.04
Increasing factors for $N_{Rk,p}$ - C40/50	ψ_c	-	1.07	1.07	1.07	1.07	1.07	1.07	1.07
Increasing factors for $N_{Rk,p}$ - C50/60	ψ_c	-	1.09	1.09	1.09	1.09	1.09	1.09	1.09
CONCRETE CONE FAILURE									
Installation safety factor	γ_2	-	1.00	1.00	1.00	1.00	1.00	1.00	1.00
Factor for cracked concrete	$k_{cr,N}$	-	7.70	7.70	7.70	7.70	7.70	7.70	7.70
Factor for non-cracked concrete	$k_{ucr,N}$	-	11.00	11.00	11.00	11.00	11.00	11.00	11.00
Edge distance	$c_{cr,N}$	[mm]	1.50	1.50	1.50	1.50	1.50	1.50	1.50
Spacing	$s_{cr,N}$	[mm]	3.00	3.00	3.00	3.00	3.00	3.00	3.00
CONCRETE SPLITTING FAILURE									
Installation safety factor	γ_{inst}	-	1.00	1.00	1.00	1.00	1.00	1.00	1.00
SHEAR LOAD									
STEEL FAILURE; STEEL CLASS 5.8									
Characteristic resistance without lever arm	$V_{Rk,s}$	[kN]	9.00	14.00	21.00	39.00	61.00	88.00	140.00
Ductility factor	k_γ	-	1.0	1.0	1.0	1.0	1.0	1.0	1.0
Characteristic resistance with lever arm	$M_{Rk,s}$	[Nm]	19.00	37.00	65.00	166.00	324.00	561.00	1124.00
Partial safety factor	γ_{Ms}	-	1.25	1.25	1.25	1.25	1.25	1.25	1.25
STEEL FAILURE; STEEL CLASS 8.8									
Characteristic resistance without lever arm	$V_{Rk,s}$	[kN]	15.00	23.00	34.00	63.00	98.00	141.00	224.00
Ductility factor	k_γ	-	1.0	1.0	1.0	1.0	1.0	1.0	1.0
Characteristic resistance with lever arm	$M_{Rk,s}$	[Nm]	30.00	60.00	105.00	266.00	519.00	898.00	1799.00
Partial safety factor	γ_{Ms}	-	1.25	1.25	1.25	1.25	1.25	1.25	1.25
STEEL FAILURE; STEEL GRADE A4-70									
Characteristic resistance without lever arm	$V_{Rk,s}$	[kN]	13.00	20.00	29.00	55.00	86.00	124.00	196.00
Ductility factor	k_γ	-	1.0	1.0	1.0	1.0	1.0	1.0	1.0
Characteristic resistance with lever arm	$M_{Rk,s}$	[Nm]	26.00	52.00	92.00	233.00	454.00	786.00	1574.00
Partial safety factor	γ_{Ms}	-	1.56	1.56	1.56	1.56	1.56	1.56	1.56
CONCRETE PRY-OUT FAILURE									
Factor	k	-	2.00	2.00	2.00	2.00	2.00	2.00	2.00
Installation safety factor	γ_2	-	1.00	1.00	1.00	1.00	1.00	1.00	1.00
CONCRETE EDGE FAILURE									
Anchor diameter	d_{nom}	[mm]	8.00	10.00	12.00	16.00	20.00	24.00	30.00
Effective length of anchor	ℓ_f	[mm]	min(300; $h_{ef}; 12d_{nom}$)	min(300; $h_{ef}; 12d_{nom}$)	min(300; $h_{ef}; 12d_{nom}$)	min(300; $h_{ef}; 12d_{nom}$)	min(300; $h_{ef}; 12d_{nom}$)	min(300; $h_{ef}; 12d_{nom}$)	min(300; $h_{ef}; 12d_{nom}$)
Installation safety factor	γ_{inst}	-	1.00	1.00	1.00	1.00	1.00	1.00	1.00

Combined pull-out and concrete cone failure:

(acc. TR 029, p.5.2.2.3. acc. to formula (5.2a) - $N_{Rk,p}^0 = n \cdot d \cdot h_{ef} \cdot \tau_{Rk}$ acc. EN 1992-4, p.7.2.1.6. acc. to formula (7.14) - $N_{Rk,p}^0 = \psi_{sus} \cdot n \cdot d \cdot h_{ef} \cdot \tau_{Rk}$ where $\psi_{sus} = \psi_{sus}^0 + 1 - \alpha_{sus} \leq 1$ (7.14a,b)).

Concrete cone failure:

(acc. TR 029, p.5.2.2.4. acc. to formula (5.3a) - $N_{Rk,c}^0 = k_\gamma \cdot F_{ck,cub} \cdot 0.5 \cdot h_{ef}^{1.5}$ Acc. EN 1992-4, p.7.2.1.4. acc. to formula (7.2) - $N_{Rk,c}^0 = k_{ucr,N} \cdot F_{ck} \cdot 0.5 \cdot h_{ef}^{1.5}$).

R-KEX-II WITH THREADED RODS

DESIGN PERFORMANCE DATA (cont.)

Allowable values for resistance in case of Seismic performance category C1

Size	M8	M10	M12	M16	M20	M24	M30
TENSION LOAD							
STEEL FAILURE; STEEL CLASS 5.8							
Characteristic resistance	$N_{Rk,s}$ [kN]	18.00	29.00	42.00	78.00	122.00	280.00
Partial safety factor	V_{Ms}	-	1.50	1.50	1.50	1.50	1.50
STEEL FAILURE; STEEL CLASS 8.8							
Characteristic resistance	$N_{Rk,s}$ [kN]	29.00	46.00	67.00	126.00	196.00	448.00
Partial safety factor	V_{Ms}	-	1.50	1.50	1.50	1.50	1.50
STEEL FAILURE; STEEL GRADE A4-70							
Characteristic resistance	$N_{Rk,s}$ [kN]	25.00	40.00	59.00	109.00	171.00	392.00
Partial safety factor	V_{Ms}	-	1.87	1.87	1.87	1.87	1.87
COMBINED PULL-OUT AND CONCRETE CONE FAILURE; NON-CRACKED CONCRETE, C20/25 (40°C/24°C)							
Characteristic bond resistance	T_{Rk} [N/mm ²]	6.00	7.00	6.50	7.00	6.00	4.00
COMBINED PULL-OUT AND CONCRETE CONE FAILURE; NON-CRACKED CONCRETE, C20/25 (80°C/50°C)							
Characteristic bond resistance	T_{Rk} [N/mm ²]	5.00	6.50	5.50	6.00	5.00	3.50
COMBINED PULL-OUT AND CONCRETE CONE FAILURE							
Installation safety factor	V_{inst}	-	1.00	1.00	1.00	1.00	1.00
SHEAR LOAD							
STEEL FAILURE; STEEL CLASS 5.8							
Characteristic resistance without lever arm	$V_{Rk,s}$ [kN]	6.30	10.10	14.70	27.30	42.70	98.00
Partial safety factor	$V_{MSV, seisc1}$	-	1.25	1.25	1.25	1.25	1.25
STEEL FAILURE; STEEL CLASS 8.8							
Characteristic resistance without lever arm	$V_{Rk,s}$ [kN]	10.20	16.10	23.50	44.10	68.60	156.80
Partial safety factor	$V_{MSV, seisc1}$	-	1.25	1.25	1.25	1.25	1.25
STEEL FAILURE; STEEL GRADE A4-70							
Characteristic resistance without lever arm	$V_{Rk,s}$ [kN]	9.10	14.40	20.70	38.50	59.90	137.40
Partial safety factor	$V_{MSV, seisc1}$	-	1.56	1.56	1.56	1.56	1.56

Allowable values for resistance in case of Seismic performance category C2

Size	M12	M16	M20	M24
TENSION LOAD				
STEEL FAILURE; STEEL CLASS 5.8				
Characteristic resistance	$N_{Rk,s}$ [kN]	42.00	78.00	122.00
Partial safety factor	V_{Ms}	-	1.50	1.50
STEEL FAILURE; STEEL CLASS 8.8				
Characteristic resistance	$N_{Rk,s}$ [kN]	67.00	126.00	196.00
Partial safety factor	V_{Ms}	-	1.50	1.50
STEEL FAILURE; STEEL GRADE A4-70				
Characteristic resistance	$N_{Rk,s}$ [kN]	59.00	109.00	171.00
Partial safety factor	V_{Ms}	-	1.87	1.87
COMBINED PULL-OUT AND CONCRETE CONE FAILURE; NON-CRACKED CONCRETE, C20/25 (40°C/24°C)				
Characteristic bond resistance	T_{Rk} [N/mm ²]	5.65	3.93	5.18
COMBINED PULL-OUT AND CONCRETE CONE FAILURE; NON-CRACKED CONCRETE, C20/25 (80°C/50°C)				
Characteristic bond resistance	T_{Rk} [N/mm ²]	5.03	3.50	4.61
COMBINED PULL-OUT AND CONCRETE CONE FAILURE				
Installation safety factor	V_{inst}	-	1.00	1.00
SHEAR LOAD				
STEEL FAILURE; STEEL CLASS 5.8				
Characteristic resistance without lever arm	$V_{Rk,s}$ [kN]	11.60	13.70	26.30
Partial safety factor	$V_{MSV, seisc1}$	-	1.25	1.25
STEEL FAILURE; STEEL CLASS 8.8				
Characteristic resistance without lever arm	$V_{Rk,s}$ [kN]	18.50	22.00	42.10
Partial safety factor	$V_{MSV, seisc1}$	-	1.25	1.25
STEEL FAILURE; STEEL GRADE A4-70				
Characteristic resistance without lever arm	$V_{Rk,s}$ [kN]	15.80	19.20	36.90
Partial safety factor	$V_{MSV, seisc1}$	-	1.56	1.56

R-KEX-I HIGH-PERFORMANCE EPOXY RESIN THREADED RODS

High performance pure epoxy resin approved for cracked and non-cracked concrete. Available in Asia-Pacific region



FEATURES AND BENEFITS

- High-performance epoxy resin for concrete
- Approved for use with threaded rods for use in non-cracked concrete (EAD 330499-00-0601)
- Suitable for use in dry and wet substrates including flooded holes (use category I1 & I2)
- Installation direction D3 (downward and horizontal and upwards installation)
- Very high chemical resistance – suitable for applications exposed to influence of various agents (industrial or marine environment).
- Extended working time ensures easy installation of metal components (up to 50 min. in 20°C).
- Working with Dustlessdrill - drilling and hole cleaning in one step
- Wide offer of rods under diameters and types of anticorrosive coating: A4, ZP, HDG, ZF and HCR

APPLICATIONS

- Safety barriers
- Formwork support systems
- Structural steelwork
- Street lamps
- Curtain walling
- Racking systems
- Balustrading
- Barriers
- Cladding restraints
- Masonry support
- Heavy machinery
- Platforms

BASE MATERIALS

- Approved for use in:
- Cracked concrete C20/25-C50/60
 - Non-cracked concrete C20/25-C50/60

INSTALLATION GUIDE

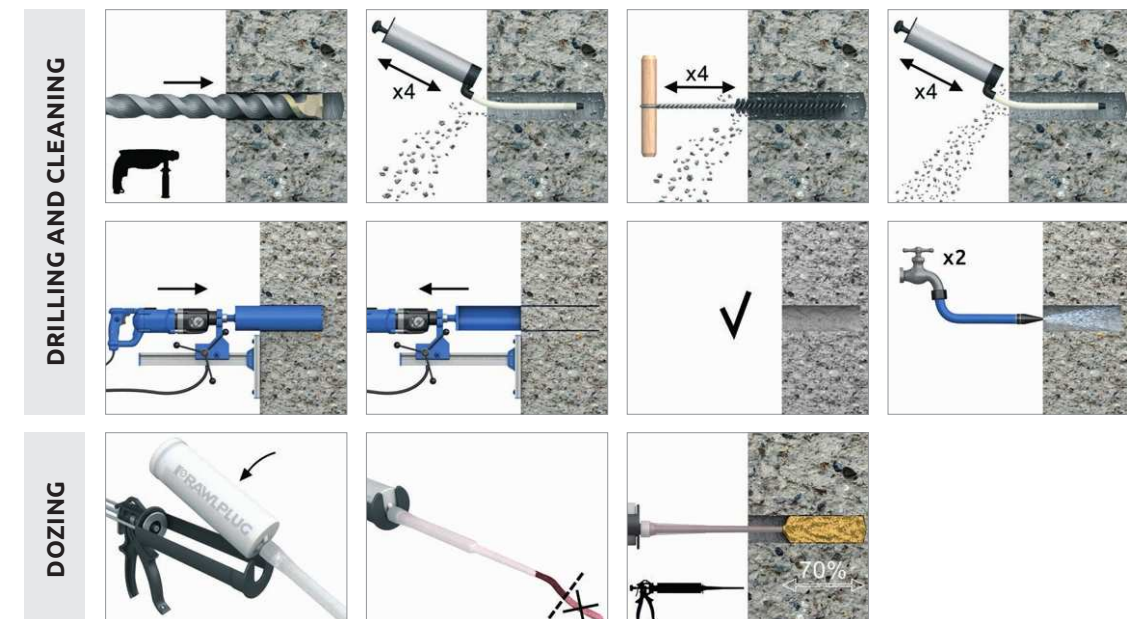

R-KEX-I HIGH-PERFORMANCE EPOXY RESIN THREADED RODS

INSTALLATION GUIDE (cont.)



1. Drill hole to the required diameter and depth for stud size being used.
2. Clean the hole thoroughly with brush and hand pump at least four times before installation.
3. Insert cartridge into gun and attach nozzle.
4. Dispense to waste until even colour is obtained.
5. Insert the mixing nozzle to the far end of the hole and inject resin, slowly withdrawing the nozzle as the hole is filled to 70% of its depth.
6. Immediately insert the stud, slowly and with slight twisting motion. Remove any excess resin around the hole before it sets and leave it undisturbed until the curing time elapses.
7. Attach fixture and tighten the nut to the required torque.

PRODUCT INFORMATION

Product Code	Resin	Description / Resin Type	Volume
			[ml]
R-KEX-I-600	R-KEX I	Epoxy Resin	600

R-STUDS

Size	Product Code			Anchor		Fixture		
	Steel class 5.8	Steel class 8.8	Steel grade A4	Diameter	Length	Hole diameter	Max. thickness t_{fix} for:	
				d	L		d_f	$h_{nom, 12d}$
				[mm]	[mm]	[mm]	[mm]	[mm]
M8	R-STUDS-08110	R-STUDS-08110-88	R-STUDS-08110-A4	8	110	9	4	4
	R-STUDS-08160	-	R-STUDS-08160-A4	8	160	9	57	57
M10	R-STUDS-10130	R-STUDS-10130-88	R-STUDS-10130-A4	10	130	12	-	-
	R-STUDS-10170	-	-	10	170	12	38	38
M12	R-STUDS-10190	-	-	10	190	12	58	58
	R-STUDS-12160	R-STUDS-12160-88	R-STUDS-12160-A4	12	160	14	1	1
	R-STUDS-12190	-	R-STUDS-12190-A4	12	190	14	31	31
	R-STUDS-12220	-	-	12	220	14	61	-
	R-STUDS-12260	-	-	12	260	14	101	101
M16	R-STUDS-12300	R-STUDS-12300-88	R-STUDS-12300-A4	12	300	14	141	141
	R-STUDS-16190	R-STUDS-16190-88	R-STUDS-16190-A4	16	190	18	-	-
	R-STUDS-16220	R-STUDS-16220-88	-	16	220	18	9	9
	R-STUDS-16260	-	-	16	260	18	49	49
M20	R-STUDS-16300	-	-	16	300	18	89	89
	R-STUDS-16380	-	-	16	380	18	169	169
	R-STUDS-20220-88	R-STUDS-20220-88	-	-	-	-	-	-
M24	R-STUDS-20260	R-STUDS-20260-88	R-STUDS-20260-A4	20	260	22	-	-
	R-STUDS-20300	R-STUDS-20300-88	-	20	300	22	37	37
M30	R-STUDS-20350	-	-	20	350	22	87	87
	R-STUDS-24300	R-STUDS-24300-88	R-STUDS-24300-A4	24	300	26	-	-
	R-STUDS-30380	R-STUDS-30380-88	-	30	380	32	-	-

R-KEX-I HIGH-PERFORMANCE EPOXY RESIN THREADED RODS

INSTALLATION DATA

R-STUDS

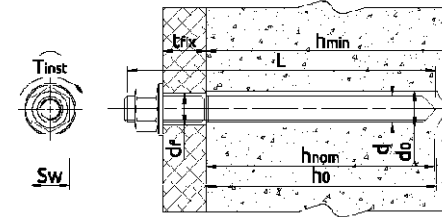

Size	M8	M10	M12	M16	M20	M24	M30		
Thread diameter	d	[mm]	8	10	12	16	20	24	30
Hole diameter in substrate	d_0	[mm]	10	12	14	18	24	28	35
Hole diameter in fixture	d_f	[mm]	9	12	14	18	22	26	32
Min. hole depth in substrate	h_0	[mm]	$h_{nom} + 5$	$h_{nom} + 5$	$h_{nom} + 5$	$h_{nom} + 5$	$h_{nom} + 5$	$h_{nom} + 5$	$h_{nom} + 5$
Min. substrate thickness	h_{min}	[mm]	$h_{nom} + 30 \geq 100$	$h_{nom} + 30 \geq 100$	$h_{nom} + 30 \geq 100$	$h_{nom} + 2d_0$	$h_{nom} + 2d_0$	$h_{nom} + 2d_0$	$h_{nom} + 2d_0$
Installation torque	T_{inst}	[Nm]	10	20	40	80	120	180	200
Min. spacing	s_{min}	[mm]	40	40	40	40	50	50	60
Min. edge distance	c_{min}	[mm]	40	40	40	40	50	50	60
MINIMUM EMBEDMENT DEPTH									
Min. installation depth	$h_{nom, min}$	[mm]	60	60	70	80	90	96	120
MAXIMUM EMBEDMENT DEPTH									
Min. installation depth	$h_{nom, max}$	[mm]	160	200	240	320	400	480	600

Minimum working and curing time

Resin temperature	Concrete temperature	Curing time*	Working time
[°C]	[°C]	[min]	[min]
5	5	96 h	180
10	10	72 h	120
20	20	10 h	35
25	30	5 h	20
25	40	4 h	20

* For wet concrete the curing time must be doubled

MECHANICAL PROPERTIES

Size	M8	M10	M12	M16	M20	M24	M30
R-STUDS Metric Threaded Rods - Steel Class 5.8							
Nominal ultimate tensile strength - tension	F_{uk}	[N/mm ²]	500	500	500	500	500
Nominal yield strength - tension	F_{yk}	[N/mm ²]	400	400	400	400	400
Cross sectional area - tension	A_s	[mm ²]	37	58	84	157	245
Elastic section modulus	W_{el}	[mm ³]	31	62	109	278	541
Characteristic bending resistance	$M_{Rk,s}^0$	[Nm]	19	37	65	166	324
Design bending resistance	M	[Nm]	15	30	52	133	259
Allowable bending resistance	M_{rec}	[Nm]	11	21	37	95	185
R-STUDS Metric Threaded Rods - Steel Class 8.8							
Nominal ultimate tensile strength - tension	F_{uk}	[N/mm ²]	800	800	800	800	800
Nominal yield strength - tension	F_{yk}	[N/mm ²]	640	640	640	640	640
Cross sectional area - tension	A_s	[mm ²]	37	58	84	157	245
Elastic section modulus	W_{el}	[mm ³]	31	62	109	278	541
Characteristic bending resistance	$M_{Rk,s}^0$	[Nm]	30	60	105	266	519
Design bending resistance	M	[Nm]	24	48	84	213	416
Allowable bending resistance	M_{rec}	[Nm]	17	34	60	152	297
R-STUDS Metric Threaded Rods - A4							
Nominal ultimate tensile strength - tension	F_{uk}	[N/mm ²]	700	700	700	700	700
Nominal yield strength - tension	F_{yk}	[N/mm ²]	450	450	450	450	450
Cross sectional area - tension	A_s	[mm ²]	37	58	84	157	245
Elastic section modulus	W_{el}	[mm ³]	31	62	109	278	541
Characteristic bending resistance	$M_{Rk,s}^0$	[Nm]	26	52	92	233	454
Design bending resistance	M	[Nm]	17	34	59	149	291
Allowable bending resistance	M_{rec}	[Nm]	12	24	42	107	208

R-KEX-I HIGH-PERFORMANCE EPOXY RESIN THREADED RODS

BASIC PERFORMANCE DATA

R-STUDS

Performance data for single anchor without influence of edge distance and spacing

Size	M8	M10	M12	M16	M20	M24	M30	M8	M10	M12	M16	M20	M24	M30	
Substrate	Non-cracked concrete							Cracked concrete							
MEAN ULTIMATE LOAD															
TENSION LOAD N_{Rm}															
R-STUDS METRIC THREADED RODS - STEEL CLASS 5.8															
Minimum embedment depth	[kN]	18.90	30.45	44.10	67.50	88.73	111.81	143.06	18.90	27.82	33.99	47.50	62.44	76.68	100.67
Maximum embedment depth	[kN]	18.90	30.45	44.10	81.90	128.10	184.80	294.00	18.90	30.45	44.10	81.90	128.10	184.80	294.00
R-STUDS METRIC THREADED RODS - STEEL CLASS 8.8															
Minimum embedment depth	[kN]	28.9	31.4	39.5	67.50	48.3	63.51	88.7	22.1	22.1	27.8	34.0	40.6	44.7	62.4
Maximum embedment depth	[kN]	30.5	48.30	70.4	132.3	205.8	296.1	471.1	30.5	48.3	70.4	132.3	205.8	296.1	471.5
R-STUDS METRIC THREADED RODS - A4															
Minimum embedment depth	[kN]	27.3	31.4	39.5	48.3	57.6	63.5	88.7	22.1	22.1	27.8	34.0	40.6	44.7	62.4
Maximum embedment depth	[kN]	27.3	43.1	62.0	115.5	179.6	259.4	412.7	27.3	43.1	62.0	115.5	179.6	259.4	412.7
CHARACTERISTIC LOAD															
TENSION LOAD N_{Rk}															
R-STUDS METRIC THREADED RODS - STEEL CLASS 5.8															
Minimum embedment depth	[kN]	18.00	22.9	28.8	35.2	42.0	46.3	64.7	11.3	14.1	19.8	24.6	29.4	32.4	45.3
Maximum embedment depth	[kN]	18.00	29.0	42.0	78.0	122.0	176.0	280.0	18.00	29.0	42.0	78.0	122.0	176.0	280.0
R-STUDS METRIC THREADED RODS - STEEL CLASS 8.8															
Minimum embedment depth	[kN]	22.9	22.9	28.8	35.2	42.0	46.3	64.7	11.3	14.1	19.8	24.6	29.4	32.4	45.3
Maximum embedment depth	[kN]	29.0	46.0	67.0	120.6	196.0	282.0	449.0	29.0	46.0	67.0	120.6	188.5	235.2	339.3
R-STUDS METRIC THREADED RODS - A4															
Minimum embedment depth	[kN]	22.9	22.9	28.8	35.2	42.0	46.3	64.7	12.06	17.59	21.11	34.44	45.27	57.04	72.98
Maximum embedment depth	[kN]	26.0	41.0	59.0	110.0	171.0	247.0	393.0	26.0	41.0	59.0	110.0	171.0	235.2	339.3
DESIGN LOAD															
TENSION LOAD N_{Rd}															
R-STUDS METRIC THREADED RODS - STEEL CLASS 5.8															
Minimum embedment depth	[kN]	12.0	15.2	19.2	23.5	28.0	30.9	43.1	7.54	9.42	13.2	16.4	19.6	21.6	30.2
Maximum embedment depth	[kN]	12.0	19.3	28.0	52.0	81.3	117.3	186.7	12.0	19.3	28.0	52.0	81.3	117.3	186.7
R-STUDS METRIC THREADED RODS - STEEL CLASS 8.8															
Minimum embedment depth	[kN]	15.2	19.2	19.2	23.5	28.0	30.9	43.1	7.54	9.42	13.2	16.4	19.6	21.6	30.2
Maximum embedment depth	[kN]	19.3	30.7	44.7	84.0	130.7	188.0	299.3	19.3	30.7	44.7	80.4	125.7	156.8	226.2
R-STUDS METRIC THREADED RODS - A4															
Minimum embedment depth	[kN]	13.9	15.2	19.2	23.5	28.0	30.9	43.1	7.54	9.42	13.2	16.4	19.6	21.6	30.2
Maximum embedment depth	[kN]	13.9	21.9	31.6	58.8	91.4	132.1	210.2	13.9	21.9	31.6	58.8	91.4	132.1	210.2

R-KEX-I HIGH-PERFORMANCE EPOXY RESIN THREADED RODS

BASIC PERFORMANCE DATA (cont.)

R-STUDS

Size	M8	M10	M12	M16	M20	M24	M30	M8	M10	M12	M16	M20	M24	M30	
SHEAR LOAD V_{Rd}															
R-STUDS METRIC THREADED RODS - STEEL CLASS 5.8															
Minimum embedment depth	[kN]	7.20	11.2	16.8	31.2	48.8	61.7	86.2	7.20	11.2	16.8	31.2	39.2	43.2	60.4
Maximum embedment depth	[kN]	7.20	11.2	16.8	31.2	48.8	70.4	112.0	7.20	11.2	16.8	31.2	48.8	70.4	112.0
R-STUDS METRIC THREADED RODS - STEEL CLASS 8.8															
Minimum embedment depth	[kN]	12.0	18.4	27.2	46.9	56.0	61.7	86.2	12.0	18.4	26.4	32.9	39.2	43.2	60.4
Maximum embedment depth	[kN]	12.0	18.4	27.2	50.4	78.4	112.8	179.2	12.0	18.4	27.2	50.4	78.4	112.8	179.2
R-STUDS METRIC THREADED RODS - A4															
Minimum embedment depth	[kN]	8.33	12.8	18.6	35.3	55.1	61.7	86.2	8.33	12.8	18.6	32.9	55.1	43.2	60.4
Maximum embedment depth	[kN]	8.33	12.8	18.6	35.3	55.1	79.5	125.6	8.33	12.8	18.6	35.3	55.1	79.5	125.6
RECOMMENDED LOAD															
TENSION LOAD N_{Rc}															
R-STUDS METRIC THREADED RODS - STEEL CLASS 5.8															
Minimum embedment depth	[kN]	8.57	13.72	16.67	23.43	30.79	38.80	49.65	5.74	8.38	10.05	16.40	21.56	27.16	34.75
Maximum embedment depth	[kN]	8.57	13.81	20.00	37.14	58.10	83.81	133.33	8.57	13.81	20.00	37.14	58.10	83.81	133.33
R-STUDS METRIC THREADED RODS - STEEL CLASS 8.8															
Minimum embedment depth	[kN]	8.57	13.72	16.67	23.43	30.79	38.80	49.65	5.74	8.38	10.05	16.40	21.56	27.16	34.75
Maximum embedment depth	[kN]	13.81	21.90	31.90	60.00	93.33	134.29	213.81	13.81	21.90	30.16	55.62	83.78	103.40	134.64
R-STUDS METRIC THREADED RODS - A4															
Minimum embedment depth	[kN]	9.93	13.72	16.76	23.43	30.79	38.80	49.65	5.74	8.38	10.05	16.40	21.56	27.16	34.75
Maximum embedment depth	[kN]	9.93	15.66	22.54	42.02	65.32	94.35	150.11	9.93	15.66	22.54	42.02	65.32	94.35	134.64
SHEAR LOAD V_{Rc}															
R-STUDS METRIC THREADED RODS - STEEL CLASS 5.8															
Minimum embedment depth	[kN]	5.14	8.00	12.00	22.29	34.86	50.29	80.00	5.14	8.00	12.00	22.29	34.86	50.29	69.51
Maximum embedment depth	[kN]	5.14	8.00	12.00	22.29	34.86	50.29	80.00	5.14	8.00	12.00	22.29	34.86	50.29	80.00
R-STUDS METRIC THREADED RODS - STEEL CLASS 8.8															
Minimum embedment depth	[kN]	8.57	13.14	19.43	36.00	56.00	77.61	99.30	8.57	13.14	19.43	32.80	43.11	54.33	69.51
Maximum embedment depth	[kN]	8.57	13.14	19.43	36.00	56.00	80.57	128.00	8.57	13.14	19.43	36.00	56.00	80.57	128.00
R-STUDS METRIC THREADED RODS - A4															
Minimum embedment depth	[kN]	5.95	9.16	13.28	25.18	39.38	56.78	89.74	5.95	9.16	13.28	25.18	39.38	54.33	69.51
Maximum embedment depth	[kN]	5.95	9.16	13.28	25.18	39.38	56.78	89.74	5.95	9.16	13.28	25.18	39.38	54.33	89.74

DESIGN PERFORMANCE DATA

R-STUDS

Size	M8	M10	M12	M16	M20	M24	M30		
TENSION LOAD									
STEEL FAILURE; STEEL CLASS 5.8									
Characteristic resistance	$N_{Rk,s}$	[kN]	18.00	29.00	42.00	78.00	122.00	176.00	280.00
Partial safety factor	γ_{Ms}	-	1.50	1.50	1.50	1.50	1.50	1.50	1.50
STEEL FAILURE; STEEL CLASS 8.8									
Characteristic resistance	$N_{Rk,s}$	[kN]	29.00	46.00	67.00	126.00	196.00	282.00	448.00
Partial safety factor	γ_{Ms}	-	1.50	1.50	1.50	1.50	1.50	1.50	1.50
STEEL FAILURE; STEEL GRADE A4-70									
Characteristic resistance	$N_{Rk,s}$	[kN]	26.00	41.00	59.00	110.00	171.00	247.00	392.00
Partial safety factor	γ_{Ms}	-	1.87	1.87	1.87	1.87	1.87	1.87	1.87
COMBINED PULL-OUT AND CONCRETE CONE FAILURE; NON-CRACKED CONCRETE, C20/25 (40°C/24°C)									
Characteristic bond resistance	T_{Rk}	[N/mm ²]	16.00	15.00	16.00	13.00	12.00	12.00	12.00
Sustained load factor	$\psi_{0,sus}$	-	0.60	0.60	0.60	0.60	0.60	0.60	0.60
COMBINED PULL-OUT AND CONCRETE CONE FAILURE; NON-CRACKED CONCRETE, C20/25 (80°C/50°C)									
Characteristic bond resistance	T_{Rk}	[N/mm ²]	16.00	15.00	16.00	13.00	12.00	12.00	12.00
Sustained load factor	$\psi_{0,sus}$	-	0.60	0.60	0.60	0.60	0.60	0.60	0.60
COMBINED PULL-OUT AND CONCRETE CONE FAILURE; CRACKED CONCRETE, C20/25 (40°C/24°C)									
Characteristic bond resistance	T_{Rk}	[N/mm ²]	7.50	7.50	7.50	7.50	7.50	6.50	6.00
Sustained load factor	$\psi_{0,sus}$	-	0.60	0.60	0.60	0.60	0.60	0.60	0.60
COMBINED PULL-OUT AND CONCRETE CONE FAILURE; CRACKED CONCRETE, C20/25 (80°C/50°C)									
Characteristic bond resistance	T_{Rk}	[N/mm ²]	7.50	7.50	7.50	7.50	7.50	6.50	6.00
Sustained load factor	$\psi_{0,sus}$	-	0.60	0.60	0.60	0.60	0.60	0.60	0.60

R-KEX-I HIGH-PERFORMANCE EPOXY RESIN THREADED RODS

DESIGN PERFORMANCE DATA (cont.)

Size	M8	M10	M12	M16	M20	M24	M30
COMBINED PULL-OUT AND CONCRETE CONE FAILURE							
Installation safety factor	V_2	-	1.00	1.00	1.00	1.00	1.00
Increasing factors for $N_{Rd,p}$ - C30/37	ψ_c	-	1.00	1.00	1.00	1.04	1.04
Increasing factors for $N_{Rd,p}$ - C40/50	ψ_c	-	1.00	1.00	1.00	1.07	1.07
Increasing factors for $N_{Rd,p}$ - C50/60	ψ_c	-	1.00	1.00	1.00	1.09	1.09
CONCRETE CONE FAILURE							
Installation safety factor	V_2	-	1.00	1.00	1.00	1.00	1.00
Factor for cracked concrete	$k_{cr,N}$	-	7.70	7.70	7.70	7.70	7.70
Factor for non-cracked concrete	$k_{ucr,N}$	-	11.00	11.00	11.00	11.00	11.00
Edge distance	$C_{cr,N}$	[mm]	$1.50 * h_{ef}$	$1.50 * h_{ef}$	$1.50 * h_{ef}$	$1.50 * h_{ef}$	$1.50 * h_{ef}$
Spacing	$S_{cr,N}$	[mm]	$3.0 * h_{ef}$	$3.0 * h_{ef}$	$3.0 * h_{ef}$	$3.0 * h_{ef}$	$3.0 * h_{ef}$
CONCRETE SPLITTING FAILURE							
Installation safety factor	V_{inst}	-	1.00	1.00	1.00	1.00	1.00
STEEL FAILURE; STEEL CLASS 5.8							
Characteristic resistance without lever arm	$V_{Rk,S}$	[kN]	9.00	14.00	21.00	39.00	61.00
Ductility factor	k_d	-	0.80	0.80	0.80	0.80	0.80
Characteristic resistance with lever arm	$M_{Rk,S}$	[Nm]	19.00	37.00	65.00	166.00	324.00
Partial safety factor	γ_{Ms}	-	1.25	1.25	1.25	1.25	1.25
STEEL FAILURE; STEEL CLASS 8.8							
Characteristic resistance without lever arm	$V_{Rk,S}$	[kN]	15.00	23.00	34.00	63.00	98.00
Ductility factor	k_d	-	0.80	0.80	0.80	0.80	0.80
Characteristic resistance with lever arm	$M_{Rk,S}$	[Nm]	30.00	60.00	105.00	266.00	519.00
Partial safety factor	γ_{Ms}	-	1.25	1.25	1.25	1.25	1.25
STEEL FAILURE; STEEL GRADE A4-70							
Characteristic resistance without lever arm	$V_{Rk,S}$	[kN]	13.00	20.00	29.00	55.00	86.00
Ductility factor	k_d	-	0.80	0.80	0.80	0.80	0.80
Characteristic resistance with lever arm	$M_{Rk,S}$	[Nm]	26.00	52.00	92.00	233.00	454.00
Partial safety factor	γ_{Ms}	-	1.56	1.56	1.56	1.56	1.56
CONCRETE PRY-OUT FAILURE							
Factor	k	-	2.00	2.00	2.00	2.00	2.00
Installation safety factor	V_2	-	1.00	1.00	1.00	1.00	1.00
CONCRETE EDGE FAILURE							
Anchor diameter	d_{nom}	[mm]	8.00	10.00	12.00	16.00	20.00
Effective length of anchor	l_f	[mm]	$\min(300; h_{ef}; 12d_{nom})$	$\min(300; h_{ef}; 12d_{nom})$	$\min(300; h_{ef}; 12d_{nom})$	$\min(300; h_{ef}; 12d_{nom})$	$\min(300; h_{ef}; 12d_{nom})$
Installation safety factor	V_{inst}	-	1.00	1.00	1.00	1.00	1.00

Combined pull-out and concrete cone failure:
 (EN 1992-4:2018, p.7.2.1.6., 7.14 - $N_{Rk,p}^0 = \psi_c^0 * \tau_{RK} * n * d * h_{ef}$).
 $h_{ef} = h_{nom}$

R-KER-II | R-CFS+KER-II HYBRID RESIN WITH THREADED RODS

High strength and versatile application in cracked and non-cracked concrete with threaded rods



FEATURES AND BENEFITS

- For faster curing winter version of the resin can be used
- Approved for 3 types of hole cleaning (including use of dustless drill bit)
- Special nozzle with longer mixer for more comfortable and precise application
- Approved for use with threaded rods in cracked and non-cracked concrete
- Suitable for use in dry or wet substrates and water filled holes
- Suitable for multiple use. Partly used product can be reused after fitting new nozzle
- Very high load capacity

APPLICATIONS

- Curtain walling
- Balustrading
- Handrails
- Canopies
- Cable conduits and trays
- Fencing & gates manufacturing and installation
- Pipework/ductwork supports
- Platforms
- Pipelines systems
- Passenger lifts
- Safety barriers
- Formwork support systems
- Structural steelwork
- Street lamps
- Racking systems
- Barriers
- Cladding restraints
- Heavy machinery

BASE MATERIALS

- Approved for use in:
- Cracked concrete C20/25-C50/60
 - Non-cracked concrete C20/25-C50/60

INSTALLATION GUIDE

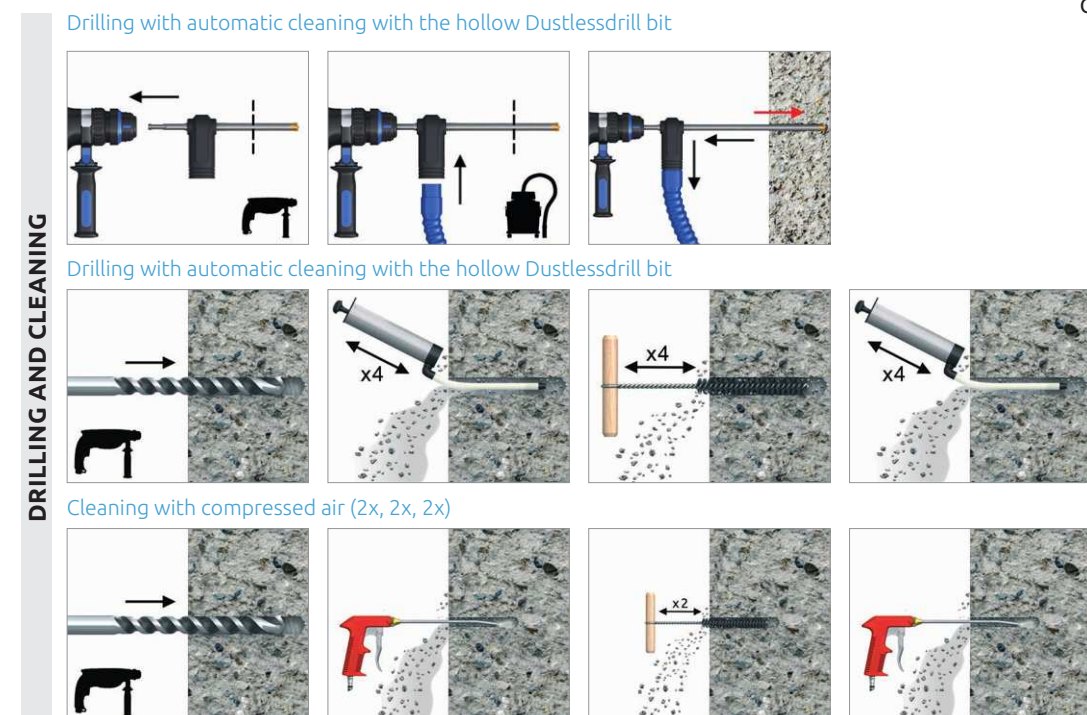

R-KER-II | R-CFS+KER-II HYBRID RESIN WITH THREADED RODS

INSTALLATION GUIDE (cont.)

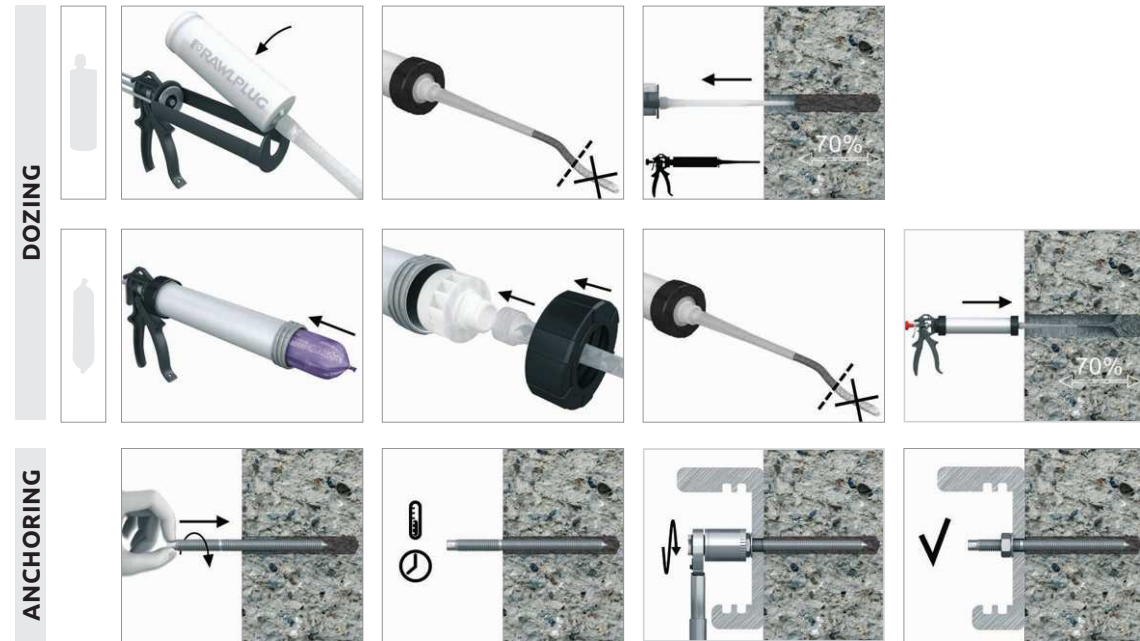

1. Drill hole to the required diameter and depth for stud size being used.
2. Clean the hole thoroughly with brush and hand pump at least four times before installation.
3. Insert cartridge into gun and attach nozzle.
4. Dispense to waste until even colour is obtained (min. 10 cm).
5. Insert the mixer nozzle to the bottom of the drill hole and inject resin, slowly withdrawing the nozzle as the hole is filled to 70% of its depth.
6. Immediately insert the stud, slowly and with slight twisting motion. Remove any excess resin around the hole before it sets and leave it undisturbed until the curing time elapses.
7. Attach fixture and tighten the nut to the required torque.

PRODUCT INFORMATION

Product Code	Resin	Description / Resin Type	Volume	
			[ml]	
R-KER-II-300	R-KER-II	R-KER II Hybrid Resin	300	
R-KER-II-345			345	
R-KER-II-400			400	
R-KER-II-300-S			R-KER II Hybrid Resin for High Temperature (Summer) / Slow Cure Styrene Free Hybrid Resin	300
R-KER-II-400-S				400
R-KER-II-300-W			R-KER II Hybrid Resin for Low Temperature (Winter) / Rapid Cure Styrene Free Hybrid Resin	300
R-KER-II-400-W				400
R-KER-II-300-SV				300
R-CFS+KERII-300			R-KER-II	Styrene Free Vinylester Resin
R-CFS+KERII-300-S	R-KER-II-S	High Temperature (Summer) / Slow Cure Styrene Free Vinylester Resin	300	
R-CFS+KERII-300-W	R-KER-II-W	Low Temperature (Winter) / Rapid Cure Styrene Free Vinylester Resin	300	

PRODUCT INFORMATION

R-STUDS

Size	Product Code			Anchor		Fixture			
	Steel class 5.8	Steel class 8.8	Steel grade A4	Diameter	Length	Hole diameter	Max. thickness t_{fix} for:		
				d [mm]	L [mm]		d_f [mm]	$h_{nom, 12d}$ [mm]	$h_{nom, 12d}$ [mm]
M8	R-STUDS-08110	R-STUDS-08110-88	R-STUDS-08110-A4	8	110	9	4	4	40
	R-STUDS-08160	-	R-STUDS-08160-A4	8	160	9	54	54	90
M10	R-STUDS-10130	R-STUDS-10130-88	R-STUDS-10130-A4	10	130	12	-	-	58
	R-STUDS-10170	-	-	10	170	12	38	38	98
	R-STUDS-10190	-	-	10	190	12	58	58	118
M12	R-STUDS-12160	R-STUDS-12160-88	R-STUDS-12160-A4	12	160	14	1	1	85
	R-STUDS-12190	-	R-STUDS-12190-A4	12	190	14	31	31	115
	R-STUDS-12220	-	-	12	220	14	61	-	145

R-KER-II | R-CFS+KER-II HYBRID RESIN WITH THREADED RODS

PRODUCT INFORMATION (cont.)

Size	Product Code			Anchor		Hole diameter	Fixture		
	Steel class 5.8	Steel class 8.8	Steel grade A4	Diameter	Length		d_f [mm]	Max. thickness t_{fix} for:	
				d [mm]	L [mm]	$h_{nom, 12d}$ [mm]		$h_{nom, 12d}$ [mm]	$h_{nom, min}$ [mm]
M12	R-STUDS-12260	-	-	12	260	14	101	101	185
	R-STUDS-12300	R-STUDS-12300-88	R-STUDS-12300-A4	12	300	14	141	141	225
M16	R-STUDS-16190	R-STUDS-16190-88	R-STUDS-16190-A4	16	190	18	-	-	111
	R-STUDS-16220	R-STUDS-16220-88	-	16	220	18	9	9	141
	R-STUDS-16260	-	-	16	260	18	49	49	181
	R-STUDS-16300	-	-	16	300	18	89	89	221
	R-STUDS-16380	-	-	16	380	18	169	169	301
M20	-	R-STUDS-20220-88	-	20	220	22	-	-	117
	R-STUDS-20260	R-STUDS-20260-88	R-STUDS-20260-A4	20	260	22	37	37	157
	R-STUDS-20300	R-STUDS-20300-88	-	20	300	22	87	87	197
-	R-STUDS-20350	-	-	20	350	22	-	-	247
M24	R-STUDS-24300	R-STUDS-24300-88	R-STUDS-24300-A4	24	300	26	-	-	176
M30	R-STUDS-30380	R-STUDS-30380-88	-	30	380	32	-	-	226

INSTALLATION DATA

R-STUDS

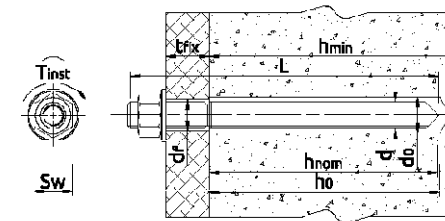

Size	M8	M10	M12	M16	M20	M24	M30	
Thread diameter	d [mm]	8	10	12	16	20	24	30
Hole diameter in substrate	d_0 [mm]	10	12	14	18	24	28	35
Hole diameter in fixture	d_f [mm]	9	12	14	18	22	26	32
Min. hole depth in substrate	h_0 [mm]	$h_{nom} + 5$	$h_{nom} + 5$	$h_{nom} + 5$	$h_{nom} + 5$	$h_{nom} + 5$	$h_{nom} + 5$	$h_{nom} + 5$
Min. substrate thickness	h_{min} [mm]	$h_{nom} + 30 \geq 100$	$h_{nom} + 30 \geq 100$	$h_{nom} + 30 \geq 100$	$h_{nom} + 2d_0$	$h_{nom} + 2d_0$	$h_{nom} + 2d_0$	$h_{nom} + 2d_0$
Installation torque	T_{inst} [Nm]	10	20	40	80	120	160	200
Min. spacing	s_{min} [mm]	40	40	40	40	40	50	60
Min. edge distance	c_{min} [mm]	40	40	40	40	40	50	60
MINIMUM EMBEDMENT DEPTH								
Min. installation depth	$h_{nom, min}$ [mm]	60	60	60	60	80	96	120
MAXIMUM EMBEDMENT DEPTH								
Min. installation depth	$h_{nom, max}$ [mm]	160	200	240	320	400	480	600

Minimum working and curing time

R-KER-II

Resin temperature °C	Concrete temperature °C	Curing time* [min.]			Working time [min]		
		R-KER-II S	R-KER-II	R-KER-II W	R-KER-II S	R-KER-II	R-KER-II W
5	-20	-	-	1440	-	-	100
5	-15	-	-	960	-	-	60
5	-10	-	-	480	-	-	40
5	-5	-	1440	240	-	40	20
5	0	-	180	120	-	30	14
5	5	720	90	60	40	15	9
10	10	480	60	45	20	8	5.5
15	15	360	60	30	15	5	3
20	20	240	45	15	10	2.5	2
25	25	180	45	10	9.5	2	1.5
25	30	120	45	10	7	2	1.5
25	35	120	30	5	6.5	1.5	1
25	40	90	30	5	6.5	1.5	1

*For wet concrete the curing time must be doubled

R-KER-II | R-CFS+KER-II

HYBRID RESIN WITH THREADED RODS

MECHANICAL PROPERTIES

Size			M8	M10	M12	M16	M20	M24	M30
R-STUDS Metric Threaded Rods - Steel Class 5.8									
Nominal ultimate tensile strength - tension	F_{uk}	[N/mm ²]	500	500	500	500	500	500	500
Nominal yield strength - tension	F_{yk}	[N/mm ²]	400	400	400	400	400	400	400
Cross sectional area - tension	A_s	[mm ²]	36.6	58	84.3	157	245	352.8	559.8
Elastic section modulus	W_{el}	[mm ³]	31.2	62.3	109.2	277.5	541	935	1868
Characteristic bending resistance	$M_{Rk,s}^0$	[Nm]	19	37	65	166	324	561	1124
Design bending resistance	M	[Nm]	15	30	52	133	259	449	899
Allowable bending resistance	M_{rec}	[Nm]	11	21	37	95	185	321	642
R-STUDS Metric Threaded Rods - Steel Class 8.8									
Nominal ultimate tensile strength - tension	F_{uk}	[N/mm ²]	800	800	800	800	800	800	800
Nominal yield strength - tension	F_{yk}	[N/mm ²]	640	640	640	640	640	640	640
Cross sectional area - tension	A_s	[mm ²]	36.6	58	84.3	157	245	352.8	559.8
Elastic section modulus	W_{el}	[mm ³]	31.2	62.3	109.2	277.5	541	935	1868
Characteristic bending resistance	$M_{Rk,s}^0$	[Nm]	30	60	105	266	519	898	1799
Design bending resistance	M	[Nm]	24	48	84	213	416	718	1439
Allowable bending resistance	M_{rec}	[Nm]	17	34	60	152	297	513	1028
R-STUDS Metric Threaded Rods - A4									
Nominal ultimate tensile strength - tension	F_{uk}	[N/mm ²]	700	700	700	700	700	700	700
Nominal yield strength - tension	F_{yk}	[N/mm ²]	450	450	450	450	450	450	450
Cross sectional area - tension	A_s	[mm ²]	36.6	58	84.3	157	245	352.8	559.8
Elastic section modulus	W_{el}	[mm ³]	31.2	62.3	109.2	277.5	541	935	1868
Characteristic bending resistance	$M_{Rk,s}^0$	[Nm]	26	52	92	233	454	786	1574
Design bending resistance	M	[Nm]	17	34	59	149	291	504	1009
Allowable bending resistance	M_{rec}	[Nm]	12	24	42	107	208	360	721

BASIC PERFORMANCE DATA

R-STUDS

Performance data for single anchor without influence of edge distance and spacing

Size		M8	M10	M12	M16	M20	M24	M30	M8	M10	M12	M16	M20	M24	M30	
Substrate		Non-cracked concrete						Cracked concrete								
MEAN ULTIMATE LOAD																
TENSION LOAD N_{Rum}																
R-STUDS METRIC THREADED RODS - STEEL CLASS 5.8																
Minimum embedment depth	[kN]	22.00	28.20	28.20	28.20	43.40	57.00	79.70	20.10	20.10	20.10	20.10	30.90	40.60	56.80	
Maximum embedment depth	[kN]	22.00	34.80	50.60	94.20	147.00	211.70	335.90	22.00	34.80	50.60	94.20	147.00	211.70	335.90	
R-STUDS METRIC THREADED RODS - STEEL CLASS 8.8																
Minimum embedment depth	[kN]	28.20	28.20	28.20	28.20	43.40	57.00	79.70	20.10	20.10	20.10	20.10	30.90	40.60	56.80	
Maximum embedment depth	[kN]	32.90	52.20	75.90	141.30	220.50	317.50	503.80	32.90	52.20	75.90	141.30	220.50	317.50	503.80	
R-STUDS METRIC THREADED RODS - A4																
Minimum embedment depth	[kN]	28.20	28.20	28.20	28.20	43.40	57.00	79.70	20.10	20.10	20.10	20.10	30.90	40.60	56.80	
Maximum embedment depth	[kN]	28.90	45.80	66.60	124.00	193.60	278.70	442.20	28.90	45.80	66.60	124.00	193.60	278.70	442.20	
 SHEAR LOAD V_{Rum}																
R-STUDS METRIC THREADED RODS - STEEL CLASS 5.8																
Minimum embedment depth	[kN]	11.00	17.40	25.30	47.10	73.50	105.80	167.90	11.00	17.40	25.30	47.10	73.50	105.80	135.70	
Maximum embedment depth	[kN]	11.00	17.40	25.30	47.10	73.50	105.80	167.90	11.00	17.40	25.30	47.10	73.50	105.80	167.90	
R-STUDS METRIC THREADED RODS - STEEL CLASS 8.8																
Minimum embedment depth	[kN]	16.50	26.10	37.90	70.70	110.30	158.80	194.30	16.50	26.10	37.90	64.30	84.80	114.10	115.00	
Maximum embedment depth	[kN]	16.50	26.10	37.90	70.70	110.30	158.80	240.40	16.50	26.10	37.90	70.70	110.30	158.80	226.90	
R-STUDS METRIC THREADED RODS - A4																
Minimum embedment depth	[kN]	14.50	22.90	33.30	62.00	96.80	139.40	221.10	14.50	22.90	33.30	62.00	85.30	114.30	170.70	
Maximum embedment depth	[kN]	14.50	22.90	33.30	62.00	96.80	139.40	221.10	14.50	22.90	33.30	62.00	96.80	139.40	221.10	

R-KER-II | R-CFS+KER-II

HYBRID RESIN WITH THREADED RODS

BASIC PERFORMANCE DATA (cont.)

Size		M8	M10	M12	M16	M20	M24	M30	M8	M10	M12	M16	M20	M24	M30
CHARACTERISTIC LOAD															
TENSION LOAD N_{Rk}															
R-STUDS METRIC THREADED RODS - STEEL CLASS 5.8															
Minimum embedment depth	[kN]	18.00	22.86	22.86	22.86	35.20	46.27	64.67	15.08	16.00	16.00	16.00	24.64	32.39	45.27
Maximum embedment depth	[kN]	18.00	29.00	42.00	78.00	122.00	176.00	280.00	18.00	29.00	42.00	78.00	122.00	176.00	280.00
R-STUDS METRIC THREADED RODS - STEEL CLASS 8.8															
Minimum embedment depth	[kN]	22.86	22.86	22.86	22.86	35.20	46.27	64.67	15.08	16.00	16.00	16.00	24.64	32.39	45.27
Maximum embedment depth	[kN]	29.00	46.00	67.00	126.00	196.00	282.00	448.00	29.00	46.00	67.00	126.00	188.50	253.34	282.74
R-STUDS METRIC THREADED RODS - A4															
Minimum embedment depth	[kN]	22.86	22.86	22.86	22.86	35.20	46.27	64.67	15.08	16.00	16.00	16.00	24.64	32.39	45.27
Maximum embedment depth	[kN]	26.00	41.00	59.00	110.00	171.00	247.00	392.00	26.00	41.00	59.00	110.00	171.00	247.00	282.74
 SHEAR LOAD V_{Rk}															
R-STUDS METRIC THREADED RODS - STEEL CLASS 5.8															
Minimum embedment depth	[kN]	9.00	14.00	21.00	39.00	61.00	88.00	129.33	9.00	14.00	21.00	32.01	49.28	64.78	90.53
Maximum embedment depth	[kN]	9.00	14.00	21.00	39.00	61.00	88.00	140.00	9.00	14.00	21.00	39.00	61.00	88.00	140.00
R-STUDS METRIC THREADED RODS - STEEL CLASS 8.8															
Minimum embedment depth	[kN]	15.00	23.00	34.00	45.73	70.40	92.54	129.33	15.00	23.00	32.01	32.01	49.28	64.78	90.53
Maximum embedment depth	[kN]	15.00	23.00	34.00	63.00	98.00	141.00	224.00	15.00	23.00	34.00	63.00	98.00	141.00	224.00
R-STUDS METRIC THREADED RODS - A4															
Minimum embedment depth	[kN]	13.00	20.00	29.00	45.73	70.40	92.54	129.33	13.00	20.00	29.00	32.01	49.28	64.78	90.53
Maximum embedment depth	[kN]	13.00	20.00	29.00	55.00	86.00	124.00	196.00	13.00	20.00	29.00	55.00	86.00	124.00	196.00
DESIGN LOAD															
TENSION LOAD N_{Rd}															
R-STUDS METRIC THREADED RODS - STEEL CLASS 5.8															
Minimum embedment depth	[kN]	12.00	15.24	15.24	15.24	23.47	30.85	43.11	10.05	10.67	10.67	10.67	16.43	21.59	30.18
Maximum embedment depth	[kN]	12.00	19.33	28.03	52.03	81.33	117.33	186.7	12.00	19.33	28.00	52.00	81.33	117.33	186.67
R-STUDS METRIC THREADED RODS - STEEL CLASS 8.8															
Minimum embedment depth	[kN]	15.24	15.24	15.24	15.24	23.47	30.85	43.11	10.05	10.67	10.67	10.67	16.43	21.59	30.18
Maximum embedment depth	[kN]	19.33	30.67	44.67	84.00	130.67	188.00	298.67	19.33	30.67	44.67	84.00	125.66	168.89	188.50
R-STUDS METRIC THREADED RODS - A4															
Minimum embedment depth	[kN]	13.90	15.24	15.24	15.24	23.47	30.85	43.11	10.05	10.67	10.67	10.67	16.43	21.59	30.18
Maximum embedment depth	[kN]	13.90	21.93	31.55	58.82	91.44	132.09	209.63	13.90	21.93	31.55	58.82	91.44	132.09	188.50
 SHEAR LOAD V_{Rd}															
R-STUDS METRIC THREADED RODS - STEEL CLASS 5.8															
Minimum embedment depth	[kN]	7.20	11.20	16.80	30.48	46.93	61.70	86.20	7.20	11.20	16.80	21.34	32.85	43.19	60.63
Maximum embedment depth	[kN]	7.20	11.20	16.80	31.20	48.80	70.40	112.0	7.20	11.20	16.80	31.20	48.80	70.40	112.00
R-STUDS METRIC THREADED RODS - STEEL CLASS 8.8															
Minimum embedment depth	[kN]	12.00	18.40	27.20	30.48	46.93	61.70	86.22	12.00	18.40	21.34	21.34	32.85	43.19	60.36
Maximum embedment depth	[kN]	12.00	18.40	27.20	50.40	78.40	112.80	179.20	12.00	18.40	27.20	50.40	78.40	112.80	179.20
R-STUDS METRIC THREADED RODS - A4															
Minimum embedment depth	[kN]	8.33	12.82	18.59	30.48	46.93	61.70	86.22	8.33	12.82	18.59	21.34	32.85	43.19	60.36
Maximum embedment depth	[kN]	8.33	12.82	18.59	35.26	55.13	79.49	125.64	8.33	12.82	18.59	35.26	55.13	79.49	125.64
RECOMMENDED LOAD															
TENSION LOAD N_{rec}															
R-STUDS METRIC THREADED RODS - STEEL CLASS 5.8															
Minimum embedment depth	[kN]	8.57	10.89	10.89	10.89	16.76	22.03	30.79	7.18	7.62	7.62	7.62	11.73	15.42	21.56
Maximum embedment depth	[kN]	8.57	13.81	20.00	37.14	58.10	83.81	133.33	8.57	13.81	20.00	37.14	58.10	83.81	133.33
R-STUDS METRIC THREADED RODS - STEEL CLASS 8.8															
Minimum embedment depth	[kN]	10.89	10.89	10.89	10.89	16.76	22.03	30.79	7.18	7.62	7.62	7.62	11.73	15.42	21.56
Maximum embedment depth	[kN]	13.81	21.90	31.90	60.00	93.33	134.3	213.29	13.81	21.90	31.09	60.00	89.76	120.64	134.64
R-STUDS METRIC THREADED RODS - A4															
Minimum embedment depth	[kN]	10.89	10.89	10.89	10.89	16.76	22.03	30.79	7.18	7.62	7.62	7.62	11.73	15.42	21.56
Maximum embedment depth	[kN]	9.93	15.66	22.54	42.02	65.32	94.35	149.73	9.93	15.66	22.54	42.02	65.32	94.35	134.64
 SHEAR LOAD V_{rec}															
R-STUDS METRIC THREADED RODS - STEEL CLASS 5.8															
Minimum embedment depth	[kN]	5.14	8.00	12.00	21.77	33.52	44.07	61.59	5.14	8.00	12.00	15.24	23.47	30.85	43.11
Maximum embedment depth	[kN]	5.14	8.00	12.00	22.29	34.86	50.29	80.00							

R-KER-II | R-CFS+KER-II

HYBRID RESIN WITH THREADED RODS

DESIGN PERFORMANCE DATA

R-STUDS

Size	M8	M10	M12	M16	M20	M24	M30
TENSION LOAD							
STEEL FAILURE; STEEL CLASS 5.8							
Characteristic resistance	$N_{Rk,s}$ [kN]	18.00	29.00	42.00	78.00	122.00	280.00
Partial safety factor	γ_{Ms}	1.50	1.50	1.50	1.50	1.50	1.50
STEEL FAILURE; STEEL CLASS 8.8							
Characteristic resistance	$N_{Rk,s}$ [kN]	29.00	46.00	67.00	126.00	196.00	448.00
Partial safety factor	γ_{Ms}	1.50	1.50	1.50	1.50	1.50	1.50
STEEL FAILURE; STEEL GRADE A4-70							
Characteristic resistance	$N_{Rk,s}$ [kN]	26.00	41.00	59.00	110.00	171.00	392.00
Partial safety factor	γ_{Ms}	1.87	1.87	1.87	1.87	1.87	1.87
WORKING LIFE 50 YEARS							
COMBINED PULL-OUT AND CONCRETE CONE FAILURE; NON-CRACKED CONCRETE, C20/25 (40°C/24°C)							
Characteristic bond resistance	T_{Rk} [N/mm ²]	16.00	15.00	15.00	13.00	10.00	8.00
Sustained load factor	ψ_{sus}^0	0.72	0.72	0.72	0.72	0.72	0.72
COMBINED PULL-OUT AND CONCRETE CONE FAILURE; NON-CRACKED CONCRETE, C20/25 (80°C/50°C)							
Characteristic bond resistance	T_{Rk} [N/mm ²]	16.00	15.00	15.00	13.00	10.00	8.00
Sustained load factor	ψ_{sus}^0	0.72	0.72	0.72	0.72	0.72	0.72
COMBINED PULL-OUT AND CONCRETE CONE FAILURE; NON-CRACKED CONCRETE, C20/25 (120°C/80°C)							
Characteristic bond resistance	T_{Rk} [N/mm ²]	8.50	8.00	8.00	7.00	5.50	4.50
Sustained load factor	ψ_{sus}^0	0.61	0.61	0.61	0.61	0.61	0.61
COMBINED PULL-OUT AND CONCRETE CONE FAILURE; CRACKED CONCRETE, C20/25 (40°C/24°C)							
Characteristic bond resistance	T_{Rk} [N/mm ²]	10.00	11.00	11.00	9.50	7.50	5.00
Sustained load factor	ψ_{sus}^0	0.72	0.72	0.72	0.72	0.72	0.72
COMBINED PULL-OUT AND CONCRETE CONE FAILURE; CRACKED CONCRETE, C20/25 (80°C/50°C)							
Characteristic bond resistance	T_{Rk} [N/mm ²]	10.00	11.00	11.00	9.50	7.50	5.00
Sustained load factor	ψ_{sus}^0	0.72	0.72	0.72	0.72	0.72	0.72
COMBINED PULL-OUT AND CONCRETE CONE FAILURE; CRACKED CONCRETE, C20/25 (120°C/80°C)							
Characteristic bond resistance	T_{Rk} [N/mm ²]	5.00	6.00	6.00	5.00	4.00	3.00
Sustained load factor	ψ_{sus}^0	0.61	0.61	0.61	0.61	0.61	0.61
WORKING LIFE 100 YEARS							
COMBINED PULL-OUT AND CONCRETE CONE FAILURE; NON-CRACKED CONCRETE, C20/25 (40°C/24°C)							
Characteristic bond resistance	T_{Rk} [N/mm ²]	15.00	15.00	14.00	13.00	10.00	8.00
Sustained load factor	ψ_{sus}^0	0.6	0.6	0.6	0.6	0.6	0.6
COMBINED PULL-OUT AND CONCRETE CONE FAILURE; NON-CRACKED CONCRETE, C20/25 (80°C/50°C)							
Characteristic bond resistance	T_{Rk} [N/mm ²]	15.00	15.00	14.00	13.00	10.00	8.00
Sustained load factor	ψ_{sus}^0	0.6	0.6	0.6	0.6	0.6	0.6
COMBINED PULL-OUT AND CONCRETE CONE FAILURE; CRACKED CONCRETE, C20/25 (40°C/24°C)							
Characteristic bond resistance	T_{Rk} [N/mm ²]	9.50	10.00	10.50	9.50	7.50	5.00
Sustained load factor	ψ_{sus}^0	0.6	0.6	0.6	0.6	0.6	0.6
COMBINED PULL-OUT AND CONCRETE CONE FAILURE; CRACKED CONCRETE, C20/25 (80°C/50°C)							
Characteristic bond resistance	T_{Rk} [N/mm ²]	9.50	10.00	10.50	9.50	7.50	5.00
Sustained load factor	ψ_{sus}^0	0.6	0.6	0.6	0.6	0.6	0.6
COMBINED PULL-OUT AND CONCRETE CONE FAILURE							
Installation safety factor	γ_2	1.00	1.00	1.00	1.00	1.00	1.00
Increasing factors for $N_{Rk,d}$ - C30/37	ψ_c	1.05	1.04	1.04	1.04	1.04	1.04
Increasing factors for $N_{Rk,d}$ - C40/50	ψ_c	1.07	1.07	1.07	1.07	1.07	1.07
Increasing factors for $N_{Rk,d}$ - C50/60	ψ_c	1.09	1.09	1.09	1.09	1.09	1.09
CONCRETE CONE FAILURE							
Installation safety factor	γ_2	1.00	1.00	1.00	1.00	1.00	1.00
Factor for cracked concrete	$k_{cr,N}$	7.70	7.70	7.70	7.70	7.70	7.70
Factor for non-cracked concrete	$k_{ucr,N}$	11.00	11.00	11.00	11.00	11.00	11.00
Edge distance	$c_{cr,N}$ [mm]	1.50	1.50	1.50	1.50	1.50	1.50
Spacing	$s_{cr,N}$ [mm]	3.0	3.0	3.0	3.0	3.0	3.0
CONCRETE SPLITTING FAILURE							
Installation safety factor	γ_2	1.00	1.00	1.00	1.00	1.00	1.00

R-KER-II | R-CFS+KER-II

HYBRID RESIN WITH THREADED RODS

DESIGN PERFORMANCE DATA (cont.)

Size	M8	M10	M12	M16	M20	M24	M30
STEEL FAILURE; STEEL CLASS 5.8							
Characteristic resistance without lever arm	$V_{Rk,s}$ [kN]	9.00	14.00	21.00	39.00	61.00	140.00
Ductility factor	k_f	0.80	0.80	0.80	0.80	0.80	0.80
Characteristic resistance with lever arm	$M_{Rk,s}$ [Nm]	19.00	37.00	65.00	166.00	324.00	1124.00
Partial safety factor	γ_{Ms}	1.25	1.25	1.25	1.25	1.25	1.25
STEEL FAILURE; STEEL CLASS 8.8							
Characteristic resistance without lever arm	$V_{Rk,s}$ [kN]	15.00	23.00	34.00	63.00	98.00	224.00
Ductility factor	k_f	0.80	0.80	0.80	0.80	0.80	0.80
Characteristic resistance with lever arm	$M_{Rk,s}$ [Nm]	30.00	60.00	105.00	266.00	519.00	1799.00
Partial safety factor	γ_{Ms}	1.25	1.25	1.25	1.25	1.25	1.25
STEEL FAILURE; STEEL GRADE A4-70							
Characteristic resistance without lever arm	$V_{Rk,s}$ [kN]	13.00	20.00	29.00	55.00	86.00	196.00
Ductility factor	k_f	0.80	0.80	0.80	0.80	0.80	0.80
Characteristic resistance with lever arm	$M_{Rk,s}$ [Nm]	26.00	52.00	92.00	233.00	454.00	1574.00
Partial safety factor	γ_{Ms}	1.56	1.56	1.56	1.56	1.56	1.56
CONCRETE PRY-OUT FAILURE							
Factor	k	2.00	2.00	2.00	2.00	2.00	2.00
Installation safety factor	γ_2	1.00	1.00	1.00	1.00	1.00	1.00
CONCRETE EDGE FAILURE							
Anchor diameter	d_{nom} [mm]	8.00	10.00	12.00	16.00	20.00	30.00
Effective length of anchor	ℓ_t [mm]	min(300; $h_{ef}; 12d_{nom}$)	min(300; $h_{ef}; 12d_{nom}$)	min(300; $h_{ef}; 12d_{nom}$)	min(300; $h_{ef}; 12d_{nom}$)	min(300; $h_{ef}; 12d_{nom}$)	min(300; $h_{ef}; 12d_{nom}$)
Installation safety factor	γ_2	1.00	1.00	1.00	1.00	1.00	1.00

Combined pull-out and concrete cone failure:
 (acc. TR 029, p.5.2.2.3. acc. to formula (5.2a) - $N_{Rk,d}^0 = n \cdot d \cdot h_{ef} \cdot \tau_{Rk}$
 acc. EN 1992-4, p.7.2.1.6. acc. to formula (7.14) - $N_{Rk,d}^0 = \psi_{sus} \cdot n \cdot d \cdot h_{ef} \cdot \tau_{Rk}$ where $\psi_{sus} = \psi_{sus}^0 + 1 - \alpha_{sus} \leq 1$ (7.14a,b)).
 Concrete cone failure:
 (acc. TR 029, p.5.2.2.4. acc. to formula (5.3a) - $N_{Rk,c}^0 = k_1 \cdot f_{ck,cube}^{0.5} \cdot h_{ef}^{1.5}$
 Acc. EN 1992-4, p.7.2.1.4. acc. to formula (7.2) - $N_{Rk,c}^0 = k_{ucr,N} \cdot f_{ck}^{0.5} \cdot h_{ef}^{1.5}$).

DESIGN PERFORMANCE DATA

Allowable values for resistance in case of Seismic performance category C1

Size	M8	M10	M12	M16	M20	M24	M30
TENSION LOAD							
STEEL FAILURE; STEEL CLASS 5.8							
Characteristic resistance	$N_{Rk,s}$ [kN]	18.00	29.00	42.00	78.00	122.00	280.00
Partial safety factor	γ_{Ms}	1.50	1.50	1.50	1.50	1.50	1.50
STEEL FAILURE; STEEL CLASS 8.8							
Characteristic resistance	$N_{Rk,s}$ [kN]	29.00	46.00	67.00	126.00	196.00	448.00
Partial safety factor	γ_{Ms}	1.50	1.50	1.50	1.50	1.50	1.50
STEEL FAILURE; STEEL GRADE A4-70							
Characteristic resistance	$N_{Rk,s}$ [kN]	26.00	41.00	59.00	110.00	171.00	392.00
Partial safety factor	γ_{Ms}	1.87	1.87	1.87	1.87	1.87	1.87
COMBINED PULL-OUT AND CONCRETE CONE FAILURE; NON-CRACKED CONCRETE, C20/25 (40°C/24°C)							
Characteristic bond resistance	T_{Rk} [N/mm ²]	8.00	10.00	10.00	9.50	7.50	4.00
COMBINED PULL-OUT AND CONCRETE CONE FAILURE; NON-CRACKED CONCRETE, C20/25 (80°C/50°C)							
Characteristic bond resistance	T_{Rk} [N/mm ²]	8.00	10.00	10.00	9.50	7.50	4.00
COMBINED PULL-OUT AND CONCRETE CONE FAILURE; NON-CRACKED CONCRETE, C20/25 (120°C/80°C)							
Characteristic bond resistance	T_{Rk} [N/mm ²]	4.50	5.00	6.00	5.00	4.00	4.00
COMBINED PULL-OUT AND CONCRETE CONE FAILURE							
Installation safety factor	γ_{inst}	1.00	1.00	1.00	1.00	1.00	1.00
STEEL FAILURE; STEEL CLASS 5.8							
Characteristic resistance without lever arm	$V_{Rk,s}$ [kN]	6.30	10.10	14.70	27.30	42.70	98.00
Partial safety factor	$\gamma_{MsV,seisC1}$	1.25	1.25	1.25	1.25	1.25	1.25
STEEL FAILURE; STEEL CLASS 8.8							
Characteristic resistance without lever arm	$V_{Rk,s}$ [kN]	10.20	16.10	23.50	44.10	68.60	156.80
Partial safety factor	$\gamma_{MsV,seisC1}$	1.25	1.25	1.25	1.25	1.25	1.25
STEEL FAILURE; STEEL GRADE A4-70							
Characteristic resistance without lever arm	$V_{Rk,s}$ [kN]	9.10	14.40	20.70	38.50	59.90	137.40
Partial safety factor	$\gamma_{MsV,seisC1}$	1.56	1.56	1.56	1.56	1.56	1.56

R-CAS-V SPIN-IN CAPSULE WITH THREADED RODS

High-performance, quick-setting, styrene-free vinyl ester resin for concrete



FEATURES AND BENEFITS

- Approved for use with threaded rods in non-cracked concrete (ETAG001 Option 7)
- High performance for use safety critical application - heavy-duty fastenings with small spacing and edge distances
- The system relies on the adhesion between the concrete and resin, which is free from expansion forces. This makes it an ideal choice where close edge and spacing distances are required
- Capsule contains precise amounts of ingredients making it a very consistent product
- Suitable for dry or wet non-cracked concrete
- Styrene free - odourless

APPLICATIONS

- Threaded rods
- Balustrading
- Railings
- Heavy machinery
- Structural steel
- Steel columns
- Cladding restraints
- Curtain walling
- Fencing & gates manufacturing and installation
- Formwork support systems
- Garage doors
- Guard rails

BASE MATERIALS

- Approved for use in:
 - Non-cracked concrete C20/25-C50/60
- Also suitable for use in:
 - Natural Stone (after site testing)

INSTALLATION GUIDE

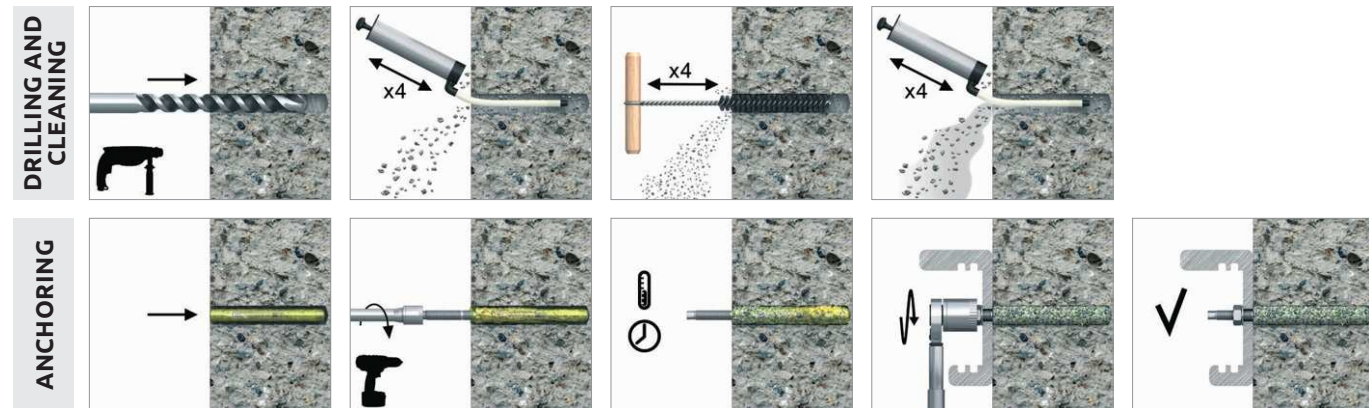

- Drill hole to the required diameter and depth for capsule size being used.
- Clean the hole thoroughly with brush and hand pump at least four times before installation.
- Insert capsule into the hole. Connect stud to drilling machine using appropriate driver system.
- Position the stud into the glass capsule then switch on the drilling machine and drive stud into the capsule. Switch off the drilling machine as soon as the bottom of hole is reached.
- Leave the anchor undisturbed until the curing time elapses.
- Attach fixture and tighten the nut to the required torque.

PRODUCT INFORMATION

Size	Product Code	Description / Resin Type
M8	R-CAS-V-08	Styrene Free Vinyl ester Resin
M10	R-CAS-V-10	
M12	R-CAS-V-12	
M16	R-CAS-V-16	
M20	R-CAS-V-20	
M24	R-CAS-V-24	
M30	R-CAS-V-30	

R-CAS-V SPIN-IN CAPSULE WITH THREADED RODS

INSTALLATION DATA

REBARS AS ANCHORS

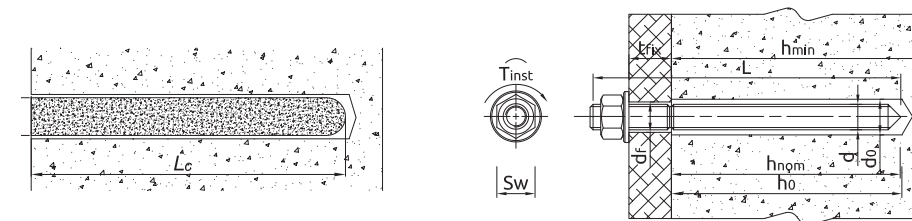

Size	M8	M10	M12	M16	M20	M24	M30		
Thread diameter	d	[mm]	8	10	12	16	20	24	30
Hole diameter in substrate	d ₀	[mm]	10	12	14	18	24	28	35
Capsule size		[mm]	8	10	12	16	20	24	30
Capsule diameter	d _c	[mm]	9.25	10.75	12.65	16.75	21.55	23.75	33.2
Installation torque	T _{inst}	[Nm]	10	20	40	80	120	180	300
Min. hole depth in substrate	h ₀	[mm]	h _{nom} + 5	h _{nom} + 5	h _{nom} + 5	h _{nom} + 5	h _{nom} + 5	h _{nom} + 5	h _{nom} + 5
Min. installation depth	h _{nom}	[mm]	80	90	110	125	170	210	270
Min. substrate thickness	h _{min}	[mm]	120	130	140	180	230	270	340
Min. spacing	s _{min}	[mm]	0.5 * h _{nom} ≥ 40	0.5 * h _{nom} ≥ 40	0.5 * h _{nom} ≥ 40	0.5 * h _{nom} ≥ 40	0.5 * h _{nom} ≥ 40	0.5 * h _{nom} ≥ 40	0.5 * h _{nom} ≥ 40
Min. edge distance	c _{min}	[mm]	0.5 * h _{nom} ≥ 40	0.5 * h _{nom} ≥ 40	0.5 * h _{nom} ≥ 40	0.5 * h _{nom} ≥ 40	0.5 * h _{nom} ≥ 40	0.5 * h _{nom} ≥ 40	0.5 * h _{nom} ≥ 40

Minimum working and curing time

Resin temperature	Concrete temperature	Curing time*	Working time
[°C]	[°C]	[min]	[min]
5	-5	480	-
5	0	240	-
5	5	150	-
10	10	120	-
15	15	90	-
20	20	45	-
25	30	20	-
25	40	10	-

* For wet concrete the curing time must be doubled

MECHANICAL PROPERTIES

Size	M8	M10	M12	M16	M20	M24	M30		
R-STUDS Metric Threaded Rods - Steel Class 5.8									
Nominal ultimate tensile strength - tension	f _{uk}	[N/mm ²]	500	500	500	500	500		
Nominal yield strength - tension	f _{yk}	[N/mm ²]	400	400	400	400	400		
Cross sectional area - tension	A _s	[mm ²]	36.6	58	84.3	157	245	352.8	559.8
Elastic section modulus	W _{el}	[mm ³]	31.2	62.3	109.2	277.5	541	935	1868
Characteristic bending resistance	M ⁰ _{Rk,s}	[Nm]	19	37	65	166	324	561	1124
Design bending resistance	M	[Nm]	15	30	52	133	259	449	899
Allowable bending resistance	M _{rec}	[Nm]	11	21	37	95	185	321	642
R-STUDS Metric Threaded Rods - Steel Class 8.8									
Nominal ultimate tensile strength - tension	f _{uk}	[N/mm ²]	800	800	800	800	800		
Nominal yield strength - tension	f _{yk}	[N/mm ²]	640	640	640	640	640		
Cross sectional area - tension	A _s	[mm ²]	36.6	58	84.3	157	245	352.8	559.8
Elastic section modulus	W _{el}	[mm ³]	31.2	62.3	109.2	277.5	541	935	1868
Characteristic bending resistance	M ⁰ _{Rk,s}	[Nm]	30	60	105	266	519	898	1799
Design bending resistance	M	[Nm]	24	48	84	213	416	718	1439
Allowable bending resistance	M _{rec}	[Nm]	17	34	60	152	297	513	1028
R-STUDS Metric Threaded Rods - A4									
Nominal ultimate tensile strength - tension	f _{uk}	[N/mm ²]	700	700	700	700	700		
Nominal yield strength - tension	f _{yk}	[N/mm ²]	450	450	450	450	450		
Cross sectional area - tension	A _s	[mm ²]	36.6	58	84.3	157	245	352.8	559.8
Elastic section modulus	W _{el}	[mm ³]	31.2	62.3	109.2	277.5	541	935	1868
Characteristic bending resistance	M ⁰ _{Rk,s}	[Nm]	26	52	92	233	454	786	1574
Design bending resistance	M	[Nm]	17	34	59	149	291	504	1009
Allowable bending resistance	M _{rec}	[Nm]	12	24	42	107	208	360	721

R-CAS-V SPIN-IN CAPSULE WITH THREADED RODS

BASIC PERFORMANCE DATA

Performance data for single anchor without influence of edge distance and spacing

Size	M8	M10	M12	M16	M20	M24	M30
Substrate							
Non-cracked concrete							
Effective embedment depth h_{ef} [mm]	80	90	110	125	170	210	270
MEAN ULTIMATE LOAD							
TENSION LOAD N_{Rm}							
R-STUDS METRIC THREADED RODS - STEEL CLASS 5.8 [kN]	18.90	30.45	44.10	82.90	128.20	171.00	259.56
R-STUDS METRIC THREADED RODS - STEEL CLASS 8.8 [kN]	30.45	40.72	59.72	82.94	128.18	171.00	259.56
R-STUDS METRIC THREADED RODS - A4 [kN]	27.30	40.72	59.72	82.94	128.18	171.00	259.56
SHEAR LOAD V_{Rm}							
R-STUDS METRIC THREADED RODS - STEEL CLASS 5.8 [kN]	11.34	18.27	26.46	49.14	76.86	110.88	176.40
R-STUDS METRIC THREADED RODS - STEEL CLASS 8.8 [kN]	18.27	29.98	42.21	79.38	123.48	177.66	282.87
R-STUDS METRIC THREADED RODS - A4 [kN]	16.38	25.83	37.17	69.30	107.73	155.61	247.59
CHARACTERISTIC LOAD							
TENSION LOAD N_{Rk}							
R-STUDS METRIC THREADED RODS - STEEL CLASS 5.8 [kN]	18.00	29.00	42.00	68.75	106.81	142.50	216.30
R-STUDS METRIC THREADED RODS - STEEL CLASS 8.8 [kN]	26.14	33.93	49.76	68.75	106.81	142.50	216.30
R-STUDS METRIC THREADED RODS - A4 [kN]	26.00	33.93	49.76	68.75	106.81	142.50	216.30
SHEAR LOAD V_{Rk}							
R-STUDS METRIC THREADED RODS - STEEL CLASS 5.8 [kN]	9.00	14.00	21.00	39.00	61.00	88.00	140.00
R-STUDS METRIC THREADED RODS - STEEL CLASS 8.8 [kN]	15.00	23.00	34.00	63.00	98.00	141.00	224.00
R-STUDS METRIC THREADED RODS - A4 [kN]	13.00	20.00	29.00	55.00	86.00	124.00	196.00
DESIGN LOAD							
TENSION LOAD N_{Rd}							
R-STUDS METRIC THREADED RODS - STEEL CLASS 5.8 [kN]	12.00	18.85	27.65	38.19	59.34	79.17	120.17
R-STUDS METRIC THREADED RODS - STEEL CLASS 8.8 [kN]	14.52	18.85	27.65	38.19	59.34	79.17	120.17
R-STUDS METRIC THREADED RODS - A4 [kN]	13.90	18.85	27.65	38.19	59.34	79.17	120.17
SHEAR LOAD V_{Rd}							
R-STUDS METRIC THREADED RODS - STEEL CLASS 5.8 [kN]	7.20	11.20	16.80	31.20	48.80	70.40	112.00
R-STUDS METRIC THREADED RODS - STEEL CLASS 8.8 [kN]	12.00	18.40	27.20	50.40	78.40	112.80	179.20
R-STUDS METRIC THREADED RODS - A4 [kN]	8.33	12.82	18.59	35.26	55.13	79.49	125.64
RECOMMENDED LOAD							
TENSION LOAD N_{Rec}							
R-STUDS METRIC THREADED RODS - STEEL CLASS 5.8 [kN]	8.57	13.46	19.75	27.28	42.39	56.55	85.83
R-STUDS METRIC THREADED RODS - STEEL CLASS 8.8 [kN]	10.37	13.46	19.75	27.28	42.39	56.55	85.83
R-STUDS METRIC THREADED RODS - A4 [kN]	9.93	13.46	19.75	27.28	42.39	56.55	85.83
SHEAR LOAD V_{Rec}							
R-STUDS METRIC THREADED RODS - STEEL CLASS 5.8 [kN]	5.14	8.00	12.00	22.29	34.86	50.29	80.00
R-STUDS METRIC THREADED RODS - STEEL CLASS 8.8 [kN]	8.57	13.14	19.43	36.00	56.00	80.57	128.00
R-STUDS METRIC THREADED RODS - A4 [kN]	5.95	9.16	13.28	25.18	39.38	56.78	89.74

DESIGN PERFORMANCE DATA

R-STUDS

Size	M8	M10	M12	M16	M20	M24	M30
Effective embedment depth h_{ef} [mm]	80.00	90.00	110.00	125.00	170.00	210.00	270.00
TENSION LOAD							
STEEL FAILURE; STEEL CLASS 5.8							
Characteristic resistance $N_{Rk,s}$ [kN]	18.00	29.00	42.00	78.00	122.00	176.00	280.00
Partial safety factor γ_{Ms}	1.50	1.50	1.50	1.50	1.50	1.50	1.50
STEEL FAILURE; STEEL CLASS 8.8							
Characteristic resistance $N_{Rk,s}$ [kN]	29.00	46.00	67.00	126.00	196.00	282.00	448.00
Partial safety factor γ_{Ms}	1.50	1.50	1.50	1.50	1.50	1.50	1.50
STEEL FAILURE; STEEL GRADE A4-70							
Characteristic resistance $N_{Rk,s}$ [kN]	26.00	41.00	59.00	110.00	171.00	247.00	392.00
Partial safety factor γ_{Ms}	1.87	1.87	1.87	1.87	1.87	1.87	1.87

R-CAS-V SPIN-IN CAPSULE WITH THREADED RODS

DESIGN PERFORMANCE DATA (cont.)

Size	M8	M10	M12	M16	M20	M24	M30
COMBINED PULL-OUT AND CONCRETE CONE FAILURE; NON-CRACKED CONCRETE, C20/25 (40°C/24°C)							
Characteristic bond resistance T_{Rk} [N/mm ²]	13.00	12.00	12.00	11.00	10.00	9.00	8.50
Sustained load factor ψ_{sus}^0	0.60	0.60	0.60	0.60	0.60	0.60	0.60
COMBINED PULL-OUT AND CONCRETE CONE FAILURE; NON-CRACKED CONCRETE, C20/25 (80°C/50°C)							
Characteristic bond resistance T_{Rk} [N/mm ²]	13.00	12.00	12.00	11.00	10.00	9.00	8.50
Sustained load factor ψ_{sus}^0	0.60	0.60	0.60	0.60	0.60	0.60	0.60
COMBINED PULL-OUT AND CONCRETE CONE FAILURE							
Installation safety factor γ_2	1.20	1.20	1.20	1.20	1.20	1.20	1.20
Increasing factors for $N_{Rd,p}$ - C30/37 ψ_c	1.04	1.04	1.04	1.04	1.04	1.00	1.00
Increasing factors for $N_{Rd,p}$ - C40/50 ψ_c	1.07	1.07	1.07	1.07	1.07	1.00	1.00
Increasing factors for $N_{Rd,p}$ - C50/60 ψ_c	1.09	1.09	1.09	1.09	1.09	1.00	1.00
CONCRETE CONE FAILURE							
Installation safety factor γ_2	1.20	1.20	1.20	1.20	1.20	1.20	1.20
Factor for non-cracked concrete $k_{ucr,N}$	11.00	11.00	11.00	11.00	11.00	11.00	11.00
Edge distance $c_{cr,N}$ [mm]	1.50	1.50	1.50	1.50	1.50	1.50	1.50
Spacing $s_{cr,N}$ [mm]	3.00	3.00	3.00	3.00	3.00	3.00	3.00
CONCRETE SPLITTING FAILURE							
Installation safety factor γ_2	1.20	1.20	1.20	1.20	1.20	1.20	1.20
STEEL FAILURE; STEEL CLASS 5.8							
Characteristic resistance without lever arm $V_{Rk,s}$ [kN]	9.00	14.00	21.00	39.00	61.00	88.00	140.00
Ductility factor k_γ	0.80	0.80	0.80	0.80	0.80	0.80	0.80
Characteristic resistance with lever arm $M_{Rk,s}$ [Nm]	19.00	37.00	65.00	166.00	324.00	561.00	1124.00
Partial safety factor γ_{Ms}	1.25	1.25	1.25	1.25	1.25	1.25	1.25
STEEL FAILURE; STEEL CLASS 8.8							
Characteristic resistance without lever arm $V_{Rk,s}$ [kN]	15.00	23.00	34.00	63.00	98.00	141.00	224.00
Ductility factor k_γ	0.80	0.80	0.80	0.80	0.80	0.80	0.80
Characteristic resistance with lever arm $M_{Rk,s}$ [Nm]	30.00	60.00	105.00	266.00	519.00	898.00	1799.00
Partial safety factor γ_{Ms}	1.25	1.25	1.25	1.25	1.25	1.25	1.25
STEEL FAILURE; STEEL GRADE A4-70							
Characteristic resistance without lever arm $V_{Rk,s}$ [kN]	13.00	20.00	29.00	55.00	86.00	124.00	196.00
Ductility factor k_γ	0.80	0.80	0.80	0.80	0.80	0.80	0.80
Characteristic resistance with lever arm $M_{Rk,s}$ [Nm]	26.00	52.00	92.00	233.00	454.00	786.00	1574.00
Partial safety factor γ_{Ms}	1.56	1.56	1.56	1.56	1.56	1.56	1.56
CONCRETE PRY-OUT FAILURE							
Factor k	2.00	2.00	2.00	2.00	2.00	2.00	2.00
Installation safety factor γ_2	1.00	1.00	1.00	1.00	1.00	1.00	1.00
CONCRETE EDGE FAILURE							
Anchor diameter d_{nom} [mm]	8.00	10.00	12.00	16.00	20.00	24.00	30.00
Effective length of anchor l_f [mm]	80.00	90.00	110.00	125.00	170.00	210.00	270.00
Installation safety factor γ_2	1.00	1.00	1.00	1.00	1.00	1.00	1.00

Combined pull-out and concrete cone failure:

(acc. TR 029, p.5.2.2.3. acc. to formula (5.2a) - $N_{Rk,p}^0 = n \cdot d \cdot h_{ef} \cdot \tau_{Rk}$
 acc. EN 1992-4, p.7.2.1.6. acc. to formula (7.14) - $N_{Rk,p}^0 = \psi_{sus} \cdot n \cdot d \cdot h_{ef} \cdot \tau_{Rk}$, where $\psi_{sus} = \psi_{sus}^0 + 1 - \alpha_{sus} \leq 1$ (7.14a,b)).

Concrete cone failure:

(acc. TR 029, p.5.2.2.4. acc. to formula (5.3a) - $N_{Rk,c}^0 = k_1 \cdot f_{ck,cube} \cdot 0.5 \cdot h_{ef}^{1.5}$
 Acc. EN 1992-4, p.7.2.1.4. acc. to formula (7.2) - $N_{Rk,c}^0 = k_{ucr,N} \cdot f_{ck} \cdot 0.5 \cdot h_{ef}^{1.5}$).

R-HAC-V HAMMER-IN WITH THREADED RODS

Heavy duty anchor with small spacing and edge distances, simply installed by hammering the threaded rods



FEATURES AND BENEFITS

- High performance anchor, for use in safety critical applications
- The system relies on the adhesion between concrete and resin, which is free from expansion forces. This makes it an ideal choice where close edge and spacing distances are required
- Capsule contains precise amounts of ingredients making it a very consistent product
- Adhesive bond strength is not affected by unpolluted water
- Suitable for dry or wet non-cracked concrete
- Low cost tooling required for installation, quick and easy to install
- Styrene free - virtually odourless
- Approved for use with threaded rods in non-cracked concrete (ETAG001 Option 7)

APPLICATIONS

- Balustrading & handrails
- Cable trays
- Guard rails
- Heavy machinery
- Threaded rods
- Cladding restraints
- Curtain walling
- Fencing & gates manufacturing and installation
- Reinforcement bars

BASE MATERIALS

- Approved for use in:
- Non-cracked concrete C20/25-C50/60
- Also suitable for use in:
- Natural Stone (after site testing)

INSTALLATION GUIDE

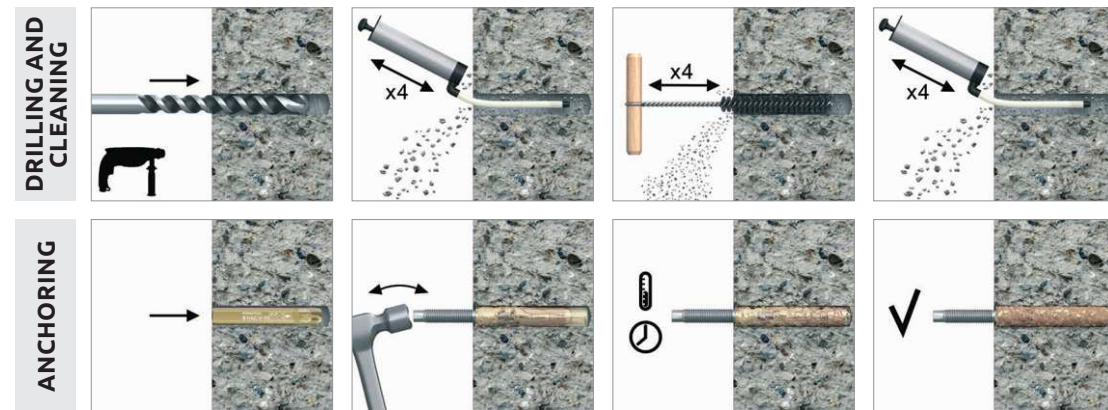

- Drill hole to the required diameter and depth for stud size being used.
- Clean the hole thoroughly with brush and hand pump at least four times before installation.
- Insert capsule into the hole.
- The stud is simply hammered through the capsule using a manual or mechanical hammer (M16-M30).
- Leave the anchor undisturbed until the curing time elapses.
- Attach fixture and tighten the nut to the required torque.

PRODUCT INFORMATION

Size	Product Code	Description / Resin Type
M8	R-HAC-V-08	Styrene Free Vinylester Resin
M10	R-HAC-V-10	
M12	R-HAC-V-12	
M16	R-HAC-V-16	
M20	R-HAC-V-20	
M24	R-HAC-V-24	
M30	R-HAC-V-30	

R-HAC-V HAMMER-IN WITH THREADED RODS

INSTALLATION DATA

R-STUDS

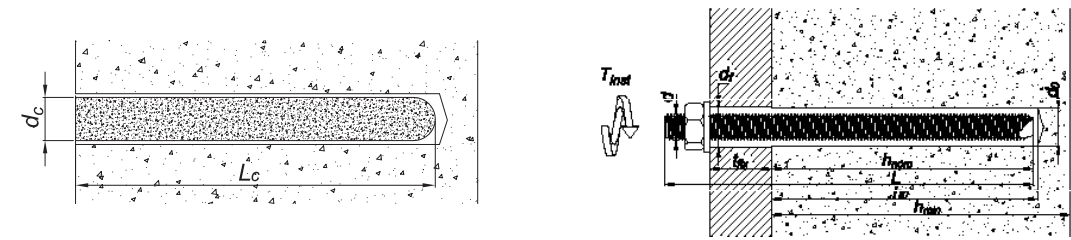

Size		M8	M10	M12	M16	M20	M24	M30
Thread diameter	d [mm]	8	10	12	16	20	24	30
Hole diameter in substrate	d ₀ [mm]	10	12	14	18	24	28	35
Capsule size	[mm]	8	10	12	16	20	24	30
Capsule diameter	d _c [mm]	9.25	10.75	12.65	16.75	21.55	23.75	33.2
Installation torque	T _{inst} [Nm]	10	20	40	80	120	180	300
Min. hole depth in substrate	h ₀ [mm]	h _{nom} + 5	h _{nom} + 5	h _{nom} + 5	h _{nom} + 5	h _{nom} + 5	h _{nom} + 5	h _{nom} + 5
Min. installation depth	h _{nom} [mm]	80	90	110	125	170	210	270
Min. substrate thickness	h _{min} [mm]	120	130	140	180	230	270	340
Min. spacing	s _{min} [mm]	0.5 * h _{nom} ≥ 40	0.5 * h _{nom} ≥ 40	0.5 * h _{nom} ≥ 40	0.5 * h _{nom} ≥ 40	0.5 * h _{nom} ≥ 40	0.5 * h _{nom} ≥ 40	0.5 * h _{nom} ≥ 40
Min. edge distance	c _{min} [mm]	0.5 * h _{nom} ≥ 40	0.5 * h _{nom} ≥ 40	0.5 * h _{nom} ≥ 40	0.5 * h _{nom} ≥ 40	0.5 * h _{nom} ≥ 40	0.5 * h _{nom} ≥ 40	0.5 * h _{nom} ≥ 40

Minimum working and curing time

Resin temperature [°C]	Concrete temperature [°C]	Curing time* [min]	Working time [min]
5	-5	1440	-
5	0	840	-
5	5	240	-
10	10	180	-
15	15	90	-
20	20	45	-
25	30	20	-
25	40	10	-

* For wet concrete the curing time must be doubled

MECHANICAL PROPERTIES

Size		M8	M10	M12	M16	M20	M24	M30
R-STUDS Metric Threaded Rods - Steel Class 5.8								
Nominal ultimate tensile strength - tension	F _{uk} [N/mm ²]	500	500	500	500	500	500	500
Nominal yield strength - tension	F _{yk} [N/mm ²]	400	400	400	400	400	400	400
Cross sectional area - tension	A _s [mm ²]	36.6	58	84.3	157	245	352.8	559.8
Elastic section modulus	W _{el} [mm ³]	31.2	62.3	109.2	277.5	541	935	1868
Characteristic bending resistance	M ⁰ _{RLS} [Nm]	19	37	65	166	324	561	1124
Design bending resistance	M [Nm]	15	30	52	133	259	449	899
Allowable bending resistance	M _{rec} [Nm]	11	21	37	95	185	321	642
R-STUDS Metric Threaded Rods - Steel Class 8.8								
Nominal ultimate tensile strength - tension	F _{uk} [N/mm ²]	800	800	800	800	800	800	800
Nominal yield strength - tension	F _{yk} [N/mm ²]	640	640	640	640	640	640	640
Cross sectional area - tension	A _s [mm ²]	36.6	58	84.3	157	245	352.8	559.8
Elastic section modulus	W _{el} [mm ³]	31.2	62.3	109.2	277.5	541	935	1868
Characteristic bending resistance	M ⁰ _{RLS} [Nm]	30	60	105	266	519	898	1799
Design bending resistance	M [Nm]	24	48	84	213	416	718	1439
Allowable bending resistance	M _{rec} [Nm]	17	34	60	152	297	513	1028
R-STUDS Metric Threaded Rods - A4								
Nominal ultimate tensile strength - tension	F _{uk} [N/mm ²]	700	700	700	700	700	700	700
Nominal yield strength - tension	F _{yk} [N/mm ²]	450	450	450	450	450	450	450
Cross sectional area - tension	A _s [mm ²]	36.6	58	84.3	157	245	352.8	559.8
Elastic section modulus	W _{el} [mm ³]	31.2	62.3	109.2	277.5	541	935	1868
Characteristic bending resistance	M ⁰ _{RLS} [Nm]	26	52	92	233	454	786	1574
Design bending resistance	M [Nm]	17	34	59	149	291	504	1009
Allowable bending resistance	M _{rec} [Nm]	12	24	42	107	208	360	721

R-HAC-V HAMMER-IN WITH THREADED RODS

BASIC PERFORMANCE DATA

R-STUDS

Performance data for single anchor without influence of edge distance and spacing

Size	M8	M10	M12	M16	M20	M24	M30
Substrate							
Non-cracked concrete							
MEAN ULTIMATE LOAD							
TENSION LOAD $N_{Rk,m}$							
R-STUDS METRIC THREADED RODS - STEEL CLASS 5.8	[kN]	18.90	30.545	44.10	75.40	115.36	213.75
R-STUDS METRIC THREADED RODS - STEEL CLASS 8.8	[kN]	26.54	37.32	49.76	75.40	115.36	213.75
R-STUDS METRIC THREADED RODS - A4	[kN]	26.5	37.3	49.8	75.4	115.4	213.8
SHEAR LOAD $V_{Rk,m}$							
R-STUDS METRIC THREADED RODS - STEEL CLASS 5.8	[kN]	11.34	18.27	26.46	49.14	76.86	110.88
R-STUDS METRIC THREADED RODS - STEEL CLASS 8.8	[kN]	18.27	28.98	42.21	79.38	123.48	282.87
R-STUDS METRIC THREADED RODS - A4	[kN]	16.38	25.83	37.17	69.30	107.37	247.59
CHARACTERISTIC LOAD							
TENSION LOAD N_{Rk}							
R-STUDS METRIC THREADED RODS - STEEL CLASS 5.8	[kN]	18.00	29.00	41.47	62.83	96.13	142.50
R-STUDS METRIC THREADED RODS - STEEL CLASS 8.8	[kN]	22.12	31.10	41.47	62.83	96.13	142.50
R-STUDS METRIC THREADED RODS - A4	[kN]	22.12	31.10	41.47	62.83	96.13	142.50
SHEAR LOAD V_{Rk}							
R-STUDS METRIC THREADED RODS - STEEL CLASS 5.8	[kN]	9.00	14.00	21.00	39.00	61.00	88.00
R-STUDS METRIC THREADED RODS - STEEL CLASS 8.8	[kN]	15.00	23.00	34.00	63.00	98.00	224.00
R-STUDS METRIC THREADED RODS - A4	[kN]	13.00	20.00	29.00	55.00	86.00	196.00
DESIGN LOAD							
TENSION LOAD N_{Rd}							
R-STUDS METRIC THREADED RODS - STEEL CLASS 5.8	[kN]	10.53	14.81	23.04	29.92	45.78	67.86
R-STUDS METRIC THREADED RODS - STEEL CLASS 8.8	[kN]	10.53	14.81	23.04	29.92	45.78	67.86
R-STUDS METRIC THREADED RODS - A4	[kN]	10.53	14.81	23.04	29.92	45.78	67.86
SHEAR LOAD V_{Rd}							
R-STUDS METRIC THREADED RODS - STEEL CLASS 5.8	[kN]	7.20	11.20	16.80	31.20	48.80	70.40
R-STUDS METRIC THREADED RODS - STEEL CLASS 8.8	[kN]	12.00	18.40	27.20	50.40	78.40	112.00
R-STUDS METRIC THREADED RODS - A4	[kN]	8.33	12.82	18.59	35.26	55.13	79.49
RECOMMENDED LOAD							
TENSION LOAD N_{rec}							
R-STUDS METRIC THREADED RODS - STEEL CLASS 5.8	[kN]	7.52	10.58	16.46	21.37	32.70	48.47
R-STUDS METRIC THREADED RODS - STEEL CLASS 8.8	[kN]	7.52	10.58	16.46	21.37	32.70	48.47
R-STUDS METRIC THREADED RODS - A4	[kN]	7.52	10.58	16.46	21.37	32.7	48.47
SHEAR LOAD V_{rec}							
R-STUDS METRIC THREADED RODS - STEEL CLASS 5.8	[kN]	5.14	8.00	12.00	22.29	34.86	50.29
R-STUDS METRIC THREADED RODS - STEEL CLASS 8.8	[kN]	8.57	13.14	19.43	36.00	56.00	80.57
R-STUDS METRIC THREADED RODS - A4	[kN]	5.95	9.16	13.28	25.18	39.38	56.78

R-HAC-V HAMMER-IN WITH THREADED RODS

DESIGN PERFORMANCE DATA

R-STUDS

Size	M8	M10	M12	M16	M20	M24	M30
Effective embedment depth	h_{ef} [mm]	80.00	90.00	110.00	125.00	170.00	210.00
TENSION LOAD							
STEEL FAILURE; STEEL CLASS 5.8							
Characteristic resistance	$N_{Rk,s}$ [kN]	18.00	29.00	42.00	78.00	122.00	176.00
Partial safety factor	γ_{Ms}	1.50	1.50	1.50	1.50	1.50	1.50
STEEL FAILURE; STEEL CLASS 8.8							
Characteristic resistance	$N_{Rk,s}$ [kN]	29.00	46.00	67.00	126.00	196.00	282.00
Partial safety factor	γ_{Ms}	1.50	1.50	1.50	1.50	1.50	1.50
STEEL FAILURE; STEEL GRADE A4-70							
Characteristic resistance	$N_{Rk,s}$ [kN]	26.00	41.00	59.00	110.00	171.00	247.00
Partial safety factor	γ_{Ms}	1.87	1.87	1.87	1.87	1.87	1.87
COMBINED PULL-OUT AND CONCRETE CONE FAILURE; NON-CRACKED CONCRETE, C20/25 (40°C/24°C)							
Characteristic bond resistance	T_{Rk} [N/mm ²]	11.00	11.00	10.00	10.00	9.00	9.00
Sustained load factor	ψ_{sus}^0	0.60	0.60	0.60	0.60	0.60	0.60
COMBINED PULL-OUT AND CONCRETE CONE FAILURE; NON-CRACKED CONCRETE, C20/25 (80°C/50°C)							
Characteristic bond resistance	T_{Rk} [N/mm ²]	9.50	9.00	8.50	8.00	7.00	6.00
Sustained load factor	ψ_{sus}^0	0.60	0.60	0.60	0.60	0.60	0.60
COMBINED PULL-OUT AND CONCRETE CONE FAILURE							
Installation safety factor	γ_2	1.40	1.40	1.20	1.40	1.40	1.40
Increasing factors for $N_{Rd,p}$ - C30/37	ψ_c	1.04	1.04	1.04	1.04	1.04	1.00
Increasing factors for $N_{Rd,p}$ - C40/50	ψ_c	1.07	1.07	1.07	1.07	1.07	1.07
Increasing factors for $N_{Rd,p}$ - C50/60	ψ_c	1.09	1.09	1.09	1.09	1.09	1.09
CONCRETE CONE FAILURE							
Installation safety factor	γ_2	1.40	1.40	1.20	1.40	1.40	1.40
Factor of the influence of sustained load	ψ_{sus}^0	0.6	0.6	0.6	0.6	0.6	0.6
Factor for non-cracked concrete	k	10.10	10.10	10.10	10.10	10.10	10.10
Factor for non-cracked concrete	$k_{ucr,N}$	11.00	11.00	11.00	11.00	11.00	11.00
Edge distance	$c_{cr,N}$ [mm]	1.50	1.50	1.50	1.50	1.50	1.50
Spacing	$s_{cr,N}$ [mm]	3.00	3.00	3.00	3.00	3.00	3.00
CONCRETE SPLITTING FAILURE							
Installation safety factor	γ_2	1.40	1.40	1.20	1.40	1.40	1.40
SHEAR LOAD							
STEEL FAILURE; STEEL CLASS 5.8							
Characteristic resistance without lever arm	$V_{Rk,s}$ [kN]	9.00	14.00	21.00	39.00	61.00	88.00
Ductility factor	k_γ	0.80	0.80	0.80	0.80	0.80	0.80
Characteristic resistance with lever arm	$M_{Rk,s}$ [Nm]	19.00	37.00	65.00	166.00	324.00	561.00
Partial safety factor	γ_{Ms}	1.25	1.25	1.25	1.25	1.25	1.25
STEEL FAILURE; STEEL CLASS 8.8							
Characteristic resistance without lever arm	$V_{Rk,s}$ [kN]	15.00	23.00	34.00	63.00	98.00	141.00
Ductility factor	k_γ	0.80	0.80	0.80	0.80	0.80	0.80
Characteristic resistance with lever arm	$M_{Rk,s}$ [Nm]	30.00	60.00	105.00	266.00	519.00	898.00
Partial safety factor	γ_{Ms}	1.25	1.25	1.25	1.25	1.25	1.25
STEEL FAILURE; STEEL GRADE A4-70							
Characteristic resistance without lever arm	$V_{Rk,s}$ [kN]	13.00	20.00	29.00	55.00	86.00	124.00
Ductility factor	k_γ	0.80	0.80	0.80	0.80	0.80	0.80
Characteristic resistance with lever arm	$M_{Rk,s}$ [Nm]	26.00	52.00	92.00	233.00	454.00	786.00
Partial safety factor	γ_{Ms}	1.56	1.56	1.56	1.56	1.56	1.56
CONCRETE PRY-OUT FAILURE							
Factor	k	2.00	2.00	2.00	2.00	2.00	2.00
Installation safety factor	γ_2	1.00	1.00	1.00	1.00	1.00	1.00
CONCRETE EDGE FAILURE							
Anchor diameter	d_{nom} [mm]	8.00	10.00	12.00	16.00	20.00	24.00
Effective length of anchor	ℓ_f [mm]	80.00	90.00	110.00	125.00	170.00	210.00
Installation safety factor	γ_2	1.00	1.00	1.00	1.00	1.00	1.00

Combined pull-out and concrete cone failure:
 (acc. TR 029, p.5.2.2.3. acc. to formula (5.2a) - $N_{Rk,p}^0 = n \cdot d \cdot h_{ef} \cdot \tau_{Rk}$
 acc. EN 1992-4, p.7.2.1.6. acc. to formula (7.14) - $N_{Rk,p}^0 = \psi_{sus} \cdot n \cdot d \cdot h_{ef} \cdot \tau_{Rk}$ where $\psi_{sus} = \psi_{sus}^0 + 1 - \alpha_{sus} \leq 1$ (7.14a,b)).
 Concrete cone failure:
 (acc. TR 029, p.5.2.2.4. acc. to formula (5.3a) - $N_{Rk,c}^0 = k_1 \cdot F_{ck,cube}^{0.5} \cdot h_{ef}^{1.5}$
 Acc. EN 1992-4, p.7.2.1.4. acc. to formula (7.2) - $N_{Rk,c}^0 = k_{ucr,N} \cdot F_{ck}^{0.5} \cdot h_{ef}^{1.5}$).

R-KEM-II | RM50 WITH THREADED RODS FOR CONCRETE

Universal polyester (styrene free) resin - European Approval for 15 substrates



FEATURES AND BENEFITS

- The most convenient bonded anchor for general purpose use
- Quick, secure and simple installation
- Product with wide spectrum of use in the medium load capacity area
- Ideal for applications where mechanical anchors are not suitable
- Easy dosage thanks to patented self-opening system and use of manual or pneumatic gun
- Option of use standard manual silicone gun
- Suitable for multiple use. Partly used product can be reused after fitting new nozzle

APPLICATIONS

- Consoles
- Staircases
- Gates
- High racking
- Canopies
- Sanitary appliances
- Steel constructions
- Railings
- Handrails
- Ladders
- Cable trays

BASE MATERIALS

- Approved for use in:
- Non-cracked concrete C20/25-C50/60
- Also suitable for use in:
- Natural Stone (after site testing)

INSTALLATION GUIDE

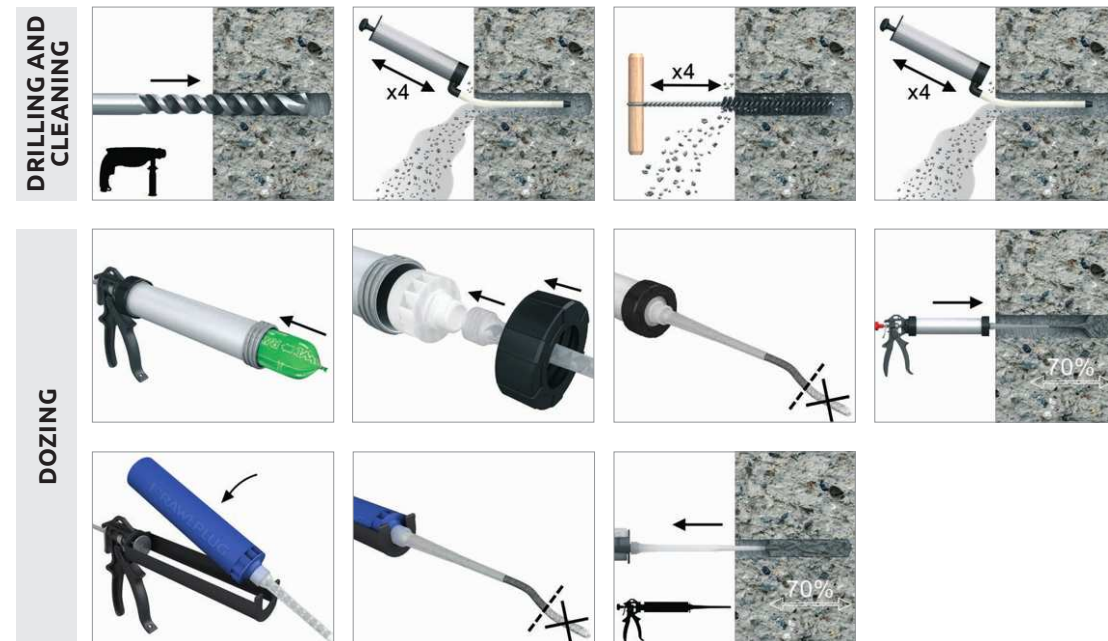

R-KEM-II | RM50 WITH THREADED RODS FOR CONCRETE

INSTALLATION GUIDE (cont.)



1. Drill hole to the required diameter and depth for stud size being used.
2. Solid substrates: clean the drill hole thoroughly with brush and hand pump at least four times before installation.
3. Insert cartridge into gun and attach nozzle.
4. Dispense to waste until even colour is obtained.
5. Insert the mixer nozzle to the bottom of the drill hole and inject resin, slowly withdrawing the nozzle as the hole is filled to 70% of its depth.
6. Immediately insert the stud, slowly and with slight twisting motion. Remove any excess resin around the hole before it sets and leave it undisturbed until the curing time elapses.
7. Attach fixture and tighten the nut to the required torque.

PRODUCT INFORMATION

Product Code	Resin	Description / Resin Type	Volume
			[ml]
R-KEM-II-175	R-KEMII	Styrene Free Polyester Resin	175
R-KEM-II-300			300
R-KEM-II-380			380
R-KEM-II-410			410
R-KEM-II-175-W	R-KEMII-W	Low Temperature (Winter) / Rapid Cure Styrene Free Polyester Resin	175
R-KEM-II-300-W			300
R-KEM-II-175-S	R-KEMII-S	High Temperature (Summer) / Slow Cure Styrene Free Polyester Resin	175
R-KEM-II-300-S			300
R-KEM-II-175-SET	R-KEMII R-KEMII	Set with 4 studs and plastic sleeves	175
R-KEM-II-300-SET			300
R-KEM-II-300-STONE		Stone colour Styrene Free Polyester Resin	300
R-KEM-II-410-STONE		410	
R-KEM-II-300-GREY		Grey colour Styrene Free Polyester Resin	300
R-KEM-II-410-GREY		410	
R-KEM-II-300-SV		Styrene Free Polyester Resin	300
R-CFS+RM50-4	RM50	Styrene Free Polyester Resin	300
R-CFS+RM50-600-8	RM50	Styrene Free Polyester Resin	600

R-STUDS

Size	Product Code			Anchor		Fixture
	Steel class 5.8	Steel class 8.8	Steel grade A4	Diameter	Length	Hole diameter
				d	L	d _f
				[mm]	[mm]	[mm]
M8	R-STUDS-08110	R-STUDS-08110-88	R-STUDS-08110-A4	8	110	9
	R-STUDS-08160	-	R-STUDS-08160-A4	8	160	9
M10	R-STUDS-10130	R-STUDS-10130-88	R-STUDS-10130-A4	10	130	12
	R-STUDS-10170	-	-	10	170	12
M12	R-STUDS-10190	-	-	10	190	12
	R-STUDS-12160	R-STUDS-12160-88	R-STUDS-12160-A4	12	160	14
M12	R-STUDS-12190	-	R-STUDS-12190-A4	12	190	14
	R-STUDS-12220	-	-	12	220	14
M12	R-STUDS-12260	-	-	12	260	14
	R-STUDS-12300	-	R-STUDS-12300-A4	12	300	14
M16	R-STUDS-16190	R-STUDS-16190-88	R-STUDS-16190-A4	16	190	18
	R-STUDS-16220	-	-	16	220	18
M16	R-STUDS-16260	-	-	16	260	18
	R-STUDS-16300	-	-	16	300	18
M16	R-STUDS-16380	-	-	16	380	18
	R-STUDS-20260	R-STUDS-20260-88	R-STUDS-20260-A4	20	260	22
M20	R-STUDS-20300	-	-	20	300	22
	R-STUDS-20350	-	-	20	350	22
M24	R-STUDS-24300	R-STUDS-24300-88	R-STUDS-24300-A4	24	300	26
M30	R-STUDS-30380	R-STUDS-30380-88	-	30	380	32

R-KEM-II | RM50 WITH THREADED RODS FOR CONCRETE

INSTALLATION DATA

R-STUDS

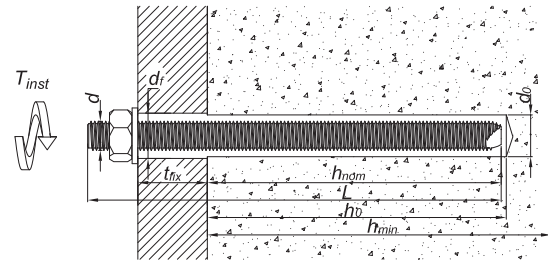

Size	M8	M10	M12	M16	M20	M24	M30	
Thread diameter	d [mm]	8	10	12	16	20	24	30
Hole diameter in substrate	d _o [mm]	10	12	14	18	24	28	35
Hole diameter in fixture	d _f [mm]	9	12	14	18	22	26	32
Min. hole depth in substrate	h _o [mm]	h _{nom} + 5	h _{nom} + 5	h _{nom} + 5	h _{nom} + 5	h _{nom} + 5	h _{nom} + 5	h _{nom} + 5
Min. substrate thickness	h _{min} [mm]	h _{nom} + 2d _o	h _{nom} + 2d _o	h _{nom} + 2d _o	h _{nom} + 2d _o	h _{nom} + 2d _o	h _{nom} + 2d _o	h _{nom} + 2d _o
Installation torque	T _{inst} [Nm]	10	20	40	80	120	180	300
Min. spacing	s _{min} [mm]	40	40	40	50	60	70	85
Min. edge distance	c _{min} [mm]	40	40	40	50	60	70	85
MINIMUM EMBEDMENT DEPTH								
Min. installation depth	h _{nom,min} [mm]	60	70	80	100	120	140	165
MAXIMUM EMBEDMENT DEPTH								
Min. installation depth	h _{nom,max} [mm]	160	200	240	320	400	480	600

Minimum working and curing time

Resin temperature [°C]	Concrete temperature [°C]	Curing time* [min]			Working time [min]		
		R-KEMII-S	R-KEMII	R-KEMII-W	R-KEMII-S	R-KEMII	R-KEMII-W
5	-20	-	-	24h	-	-	45
5	-15	-	-	18h	-	-	30
5	-10	-	-	8h	-	-	20
5	-5	24h	8h	5h	180	70	11
5	0	18h	4h	2h	120	45	7
5	5	12h	2h	1h	60	25	5
10	10	8h	90	45	45	15	2
15	15	6h	60	30	25	9	1.5
20	20	4h	45	15	15	5	1
25	30	1.5h	30	-	7	2	-
25	35	1h	-	-	6	-	-
25	40	45	-	-	5	-	-

*For wet concrete the curing time must be doubled

R-KEM-II | RM50 WITH THREADED RODS FOR CONCRETE

MECHANICAL PROPERTIES

R-STUDS

Size	M8	M10	M12	M16	M20	M24	M30
R-STUDS Metric Threaded Rods - Steel Class 5.8							
Nominal ultimate tensile strength - tension	F _{uk} [N/mm ²]	500	500	500	500	500	500
Nominal yield strength - tension	F _{yk} [N/mm ²]	400	400	400	400	400	400
Cross sectional area - tension	A _s [mm ²]	36.6	58	84.3	157	245	352.8
Elastic section modulus	W _{el} [mm ³]	31.2	62.3	109.2	277.5	541	935
Characteristic bending resistance	M _{Rk,s} [Nm]	19	37	65	166	324	561
Design bending resistance	M [Nm]	15	30	52	133	259	449
Allowable bending resistance	M _{rec} [Nm]	11	21	37	95	185	321
R-STUDS Metric Threaded Rods - Steel Class 8.8							
Nominal ultimate tensile strength - tension	F _{uk} [N/mm ²]	800	800	800	800	800	800
Nominal yield strength - tension	F _{yk} [N/mm ²]	640	640	640	640	640	640
Cross sectional area - tension	A _s [mm ²]	36.6	58	84.3	157	245	352.8
Elastic section modulus	W _{el} [mm ³]	31.2	62.3	109.2	277.5	541	935
Characteristic bending resistance	M _{Rk,s} [Nm]	30	60	105	266	519	898
Design bending resistance	M [Nm]	24	48	84	213	416	718
Allowable bending resistance	M _{rec} [Nm]	17	34	60	152	297	513
R-STUDS Metric Threaded Rods - A4							
Nominal ultimate tensile strength - tension	F _{uk} [N/mm ²]	700	700	700	700	700	700
Nominal yield strength - tension	F _{yk} [N/mm ²]	450	450	450	450	450	450
Cross sectional area - tension	A _s [mm ²]	36.6	58	84.3	157	245	352.8
Elastic section modulus	W _{el} [mm ³]	31.2	62.3	109.2	277.5	541	935
Characteristic bending resistance	M _{Rk,s} [Nm]	26	52	92	233	454	786
Design bending resistance	M [Nm]	17	34	59	149	291	504
Allowable bending resistance	M _{rec} [Nm]	12	24	42	107	208	360

BASIC PERFORMANCE DATA

R-STUDS

Performance data for single anchor without influence of edge distance and spacing

Size	M8	M10	M12	M16	M20	M24	M30
Substrate: Non-cracked concrete							
MEAN ULTIMATE LOAD							
TENSION LOAD N_{Rk,m}							
R-STUDS METRIC THREADED RODS - STEEL CLASS 5.8							
Minimum embedment depth [kN]	18.90	26.39	40.72	63.35	88.73	111.81	143.06
Maximum embedment depth [kN]	18.90	30.45	44.10	81.90	128.10	184.80	294.00
R-STUDS METRIC THREADED RODS - STEEL CLASS 8.8							
Minimum embedment depth [kN]	21.11	26.39	40.72	63.35	88.73	111.81	143.06
Maximum embedment depth [kN]	30.45	48.30	70.35	132.30	205.80	296.10	471.45
R-STUDS METRIC THREADED RODS - A4							
Minimum embedment depth [kN]	21.11	26.39	40.72	63.35	88.73	111.81	143.06
Maximum embedment depth [kN]	27.30	43.05	61.95	115.50	179.55	259.35	412.65
SHEAR LOAD V_{Rk,m}							
R-STUDS METRIC THREADED RODS - STEEL CLASS 5.8							
Minimum embedment depth [kN]	11.34	18.27	26.46	49.14	76.86	110.88	176.40
Maximum embedment depth [kN]	11.34	18.27	26.46	49.14	76.86	110.88	176.40
R-STUDS METRIC THREADED RODS - STEEL CLASS 8.8							
Minimum embedment depth [kN]	18.27	28.98	42.21	79.38	123.48	177.66	279.92
Maximum embedment depth [kN]	18.27	28.98	42.21	79.38	123.48	177.66	279.92
R-STUDS METRIC THREADED RODS - A4							
Minimum embedment depth [kN]	16.38	25.83	37.17	69.30	107.73	155.61	247.59
Maximum embedment depth [kN]	16.38	25.83	37.17	69.30	107.73	155.61	247.59

R-KEM-II | RM50 WITH THREADED RODS FOR CONCRETE

BASIC PERFORMANCE DATA (cont.)

Size		M8	M10	M12	M16	M20	M24	M30
CHARACTERISTIC LOAD								
TENSION LOAD N_{Rk}								
R-STUDS METRIC THREADED RODS - STEEL CLASS 5.8								
Minimum embedment depth	[kN]	14.33	20.89	27.14	40.21	60.32	68.61	85.53
Maximum embedment depth	[kN]	18.00	29.00	42.00	78.00	122.00	176.00	280.00
R-STUDS METRIC THREADED RODS - STEEL CLASS 8.8								
Minimum embedment depth	[kN]	14.33	20.89	27.14	40.21	60.32	68.61	85.53
Maximum embedment depth	[kN]	29.00	46.00	67.00	126.00	196.00	235.24	311.02
R-STUDS METRIC THREADED RODS - A4								
Minimum embedment depth	[kN]	14.33	20.89	27.14	40.21	60.32	68.61	85.53
Maximum embedment depth	[kN]	26.00	41.00	59.00	110.00	171.00	235.24	311.02
DESIGN LOAD								
TENSION LOAD N_{Rd}								
R-STUDS METRIC THREADED RODS - STEEL CLASS 5.8								
Minimum embedment depth	[kN]	6.82	11.61	15.08	22.34	33.51	38.12	47.52
Maximum embedment depth	[kN]	12.00	19.33	28.00	52.00	81.33	117.33	172.79
R-STUDS METRIC THREADED RODS - STEEL CLASS 8.8								
Minimum embedment depth	[kN]	6.82	11.61	15.08	22.34	33.51	38.12	47.52
Maximum embedment depth	[kN]	18.19	30.67	44.67	71.49	111.70	130.69	172.79
R-STUDS METRIC THREADED RODS - A4								
Minimum embedment depth	[kN]	6.82	11.61	15.08	22.34	33.51	38.12	47.52
Maximum embedment depth	[kN]	13.90	21.93	31.55	58.82	91.44	130.69	172.79
SHEAR LOAD V_{Rd}								
R-STUDS METRIC THREADED RODS - STEEL CLASS 5.8								
Minimum embedment depth	[kN]	7.20	11.20	16.80	31.20	48.80	70.40	112.00
Maximum embedment depth	[kN]	7.20	11.20	16.80	31.20	48.80	70.40	112.00
R-STUDS METRIC THREADED RODS - STEEL CLASS 8.8								
Minimum embedment depth	[kN]	12.0	18.40	27.20	50.40	78.40	91.48	114.04
Maximum embedment depth	[kN]	12.0	18.40	27.20	50.40	78.40	112.80	179.20
R-STUDS METRIC THREADED RODS - A4								
Minimum embedment depth	[kN]	8.33	12.82	18.59	35.26	55.13	79.49	114.04
Maximum embedment depth	[kN]	8.33	12.82	18.59	35.26	55.13	79.49	125.64
RECOMMENDED LOAD								
TENSION LOAD N_{Rc}								
R-STUDS METRIC THREADED RODS - STEEL CLASS 5.8								
Minimum embedment depth	[kN]	4.87	8.29	10.77	15.96	23.94	27.23	33.94
Maximum embedment depth	[kN]	5.87	13.81	20.00	37.14	58.10	83.81	123.42
R-STUDS METRIC THREADED RODS - STEEL CLASS 8.8								
Minimum embedment depth	[kN]	4.87	8.29	10.77	15.96	23.94	27.23	33.94
Maximum embedment depth	[kN]	12.99	21.90	31.90	51.06	79.79	93.35	123.42
R-STUDS METRIC THREADED RODS - A4								
Minimum embedment depth	[kN]	4.87	8.29	10.77	15.96	23.94	27.23	33.94
Maximum embedment depth	[kN]	9.93	15.66	22.54	42.02	65.32	93.35	123.42
SHEAR LOAD V_{Rc}								
R-STUDS METRIC THREADED RODS - STEEL CLASS 5.8								
Minimum embedment depth	[kN]	5.14	8.00	12.00	22.29	34.86	50.29	80.00
Maximum embedment depth	[kN]	5.14	8.00	12.00	22.29	34.86	50.29	80.00
R-STUDS METRIC THREADED RODS - STEEL CLASS 8.8								
Minimum embedment depth	[kN]	8.57	13.14	19.43	36.00	56.00	65.35	81.46
Maximum embedment depth	[kN]	8.57	13.14	19.43	36.00	56.00	80.36	128.0
R-STUDS METRIC THREADED RODS - A4								
Minimum embedment depth	[kN]	5.95	9.16	13.28	25.18	39.38	56.78	81.46
Maximum embedment depth	[kN]	5.95	9.16	13.28	25.18	39.38	56.78	89.74

R-KEM-II | RM50 WITH THREADED RODS FOR CONCRETE

DESIGN PERFORMANCE DATA

Size		M8	M10	M12	M16	M20	M24	M30
TENSION LOAD								
STEEL FAILURE; STEEL CLASS 5.8								
Characteristic resistance	$N_{Rk,s}$ [kN]	18.00	29.00	42.00	78.00	122.00	176.00	280.00
Partial safety factor	γ_{Ms}	1.50	1.50	1.50	1.50	1.50	1.50	1.50
STEEL FAILURE; STEEL CLASS 8.8								
Characteristic resistance	$N_{Rk,s}$ [kN]	29.00	46.00	67.00	126.00	196.00	282.00	448.00
Partial safety factor	γ_{Ms}	1.50	1.50	1.50	1.50	1.50	1.50	1.50
STEEL FAILURE; STEEL GRADE A4-70								
Characteristic resistance	$N_{Rk,s}$ [kN]	26.00	41.00	59.00	110.00	171.00	247.00	392.00
Partial safety factor	γ_{Ms}	1.87	1.87	1.87	1.87	1.87	1.87	1.87
WORKING LIFE 50 YEARS								
COMBINED PULL-OUT AND CONCRETE CONE FAILURE; NON-CRACKED CONCRETE, C20/25 (40°C/24°C)								
Characteristic bond resistance	T_{Rk} [N/mm ²]	9.50	9.50	9.00	8.00	8.00	6.50	5.50
Sustained load factor	ψ_{sus}^0	0.76	0.76	0.76	0.76	0.76	0.76	0.76
COMBINED PULL-OUT AND CONCRETE CONE FAILURE; NON-CRACKED CONCRETE, C20/25 (80°C/50°C)								
Characteristic bond resistance	T_{Rk} [N/mm ²]	8.00	8.00	7.50	7.00	6.50	5.00	4.50
Sustained load factor	ψ_{sus}^0	0.76	0.76	0.76	0.76	0.76	0.76	0.76
WORKING LIFE 100 YEARS								
COMBINED PULL-OUT AND CONCRETE CONE FAILURE; NON-CRACKED CONCRETE, C20/25 (40°C/24°C)								
Characteristic bond resistance	T_{Rk} [N/mm ²]	9.00	9.00	8.50	7.50	7.50	6.00	5.00
Sustained load factor	ψ_{sus}^0	0.6	0.6	0.6	0.6	0.6	0.6	0.6
COMBINED PULL-OUT AND CONCRETE CONE FAILURE; NON-CRACKED CONCRETE, C20/25 (80°C/50°C)								
Characteristic bond resistance	T_{Rk} [N/mm ²]	7.00	7.00	7.00	6.50	6.00	5.00	4.00
Sustained load factor	ψ_{sus}^0	0.6	0.6	0.6	0.6	0.6	0.6	0.6
CONCRETE CONE FAILURE								
Installation safety factor	V_{inst}	1.40	1.20	1.20	1.20	1.20	1.20	1.20
Factor for non-cracked concrete	$k_{ucr,N}$	11.00	11.00	11.00	11.00	11.00	11.00	11.00
Edge distance	$c_{cr,N}$ [mm]	1.50	1.50	1.50	1.50	1.50	1.50	1.50
Spacing	$s_{cr,N}$ [mm]	3.00	3.00	3.00	3.00	3.00	3.00	3.00
CONCRETE SPLITTING FAILURE								
Installation safety factor	V_{inst}	1.40	1.20	1.20	1.20	1.20	1.20	1.20
SHEAR LOAD								
STEEL FAILURE; STEEL CLASS 5.8								
Characteristic resistance without lever arm	$V_{Rk,s}$ [kN]	9.00	14.00	21.00	39.00	61.00	88.00	140.00
Ductility factor	k_{γ}	0.80	0.80	0.80	0.80	0.80	0.80	0.80
Characteristic resistance with lever arm	$M_{Rk,s}$ [Nm]	19.00	37.00	65.00	166.00	324.00	561.00	1124.00
Partial safety factor	γ_{Ms}	1.25	1.25	1.25	1.25	1.25	1.25	1.25
STEEL FAILURE; STEEL CLASS 8.8								
Characteristic resistance without lever arm	$V_{Rk,s}$ [kN]	15.00	23.00	34.00	63.00	98.00	141.00	224.00
Ductility factor	k_{γ}	0.80	0.80	0.80	0.80	0.80	0.80	0.80
Characteristic resistance with lever arm	$M_{Rk,s}$ [Nm]	30.00	60.00	105.00	266.00	519.00	898.00	1799.00
Partial safety factor	γ_{Ms}	1.25	1.25	1.25	1.25	1.25	1.25	1.25
STEEL FAILURE; STEEL GRADE A4-70								
Characteristic resistance without lever arm	$V_{Rk,s}$ [kN]	13.00	20.00	29.00	55.00	86.00	124.00	196.00
Ductility factor	k_{γ}	0.80	0.80	0.80	0.80	0.80	0.80	0.80
Characteristic resistance with lever arm	$M_{Rk,s}$ [Nm]	26.00	52.00	92.00	233.00	454.00	786.00	1574.00
Partial safety factor	γ_{Ms}	1.56	1.56	1.56	1.56	1.56	1.56	1.56
CONCRETE PRY-OUT FAILURE								
Factor	k	2.00	2.00	2.00	2.00	2.00	2.00	2.00
Installation safety factor	V_2	1.00	1.00	1.00	1.00	1.00	1.00	1.00
CONCRETE EDGE FAILURE								
Anchor diameter	d_{nom} [mm]	8.00	10.00	12.00	16.00	20.00	24.00	30.00
Effective length of anchor	l_f [mm]	min(300; $h_{ef}; 12d_{nom}$)	min(300; $h_{ef}; 12d_{nom}$)	min(300; $h_{ef}; 12d_{nom}$)	min(300; $h_{ef}; 12d_{nom}$)	min(300; $h_{ef}; 12d_{nom}$)	min(300; $h_{ef}; 12d_{nom}$)	min(300; $h_{ef}; 12d_{nom}$)
Installation safety factor	V_2	1.00	1.00	1.00	1.00	1.00	1.00	1.00

Combined pull-out and concrete cone failure:
 (acc. TR 029, p.5.2.2.3. acc. to formula (5.2a) - $N_{Rk,D}^0 = n \cdot d \cdot h_{ef} \cdot \tau_{Rk}$
 acc. EN 1992-4, p.7.2.1.6. acc. to formula (7.14) - $N_{Rk,D}^0 = \psi_{sus} \cdot n \cdot d \cdot h_{ef} \cdot \tau_{Rk}$ where $\psi_{sus} = \psi_{sus}^0 + 1 - \alpha_{sus} \leq 1$ (7.14a,b)).
 Concrete cone failure:
 (acc. TR 029, p.5.2.2.4. acc. to formula (5.3a) - $N_{Rk,C}^0 = k_1 \cdot f_{dk,cube} \cdot h_{ef}^{1.5}$
 Acc. EN 1992-4, p.7.2.1.4. acc. to formula (7.2) - $N_{Rk,C}^0 = k_{ucr,N} \cdot f_{dk} \cdot h_{ef}^{1.5}$).

R-KEX-II WITH INTERNALLY THREADED SOCKETS (ITS)

Premium pure epoxy resin approved for use with internally threaded sockets



FEATURES AND BENEFITS

- Allows removal of bolt to leave a re-usable socket in place
- Approved for use with sockets (ITS) for use in non-cracked concrete (EAD 330499-00-0601)
- Suitable for use in dry and wet substrates including flooded holes (use category I1 & I2)
- Very high chemical resistance – suitable for applications exposed to influence of various agents (industrial or marine environment)
- Extended working time ensures easy installation of metal components (up to 30 min. in 20°C)
- For use in positive temperatures

APPLICATIONS

- Safety barriers
- Temporary works/formworks support systems
- Balustrading
- Barriers
- Cladding restraints
- Masonry support
- Heavy machinery
- Platforms
- Structural steelwork

BASE MATERIALS

- Approved for use in: Non-cracked concrete C20/25-C50/60

INSTALLATION GUIDE

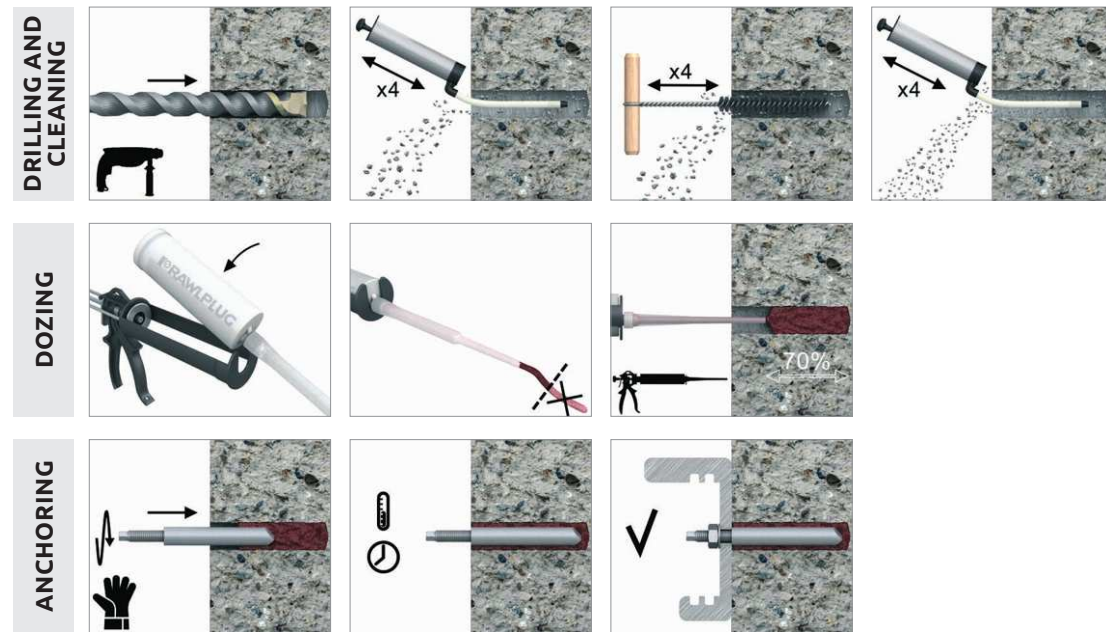

R-KEX-II WITH INTERNALLY THREADED SOCKETS (ITS)

INSTALLATION GUIDE (cont.)

- Drill hole to the required diameter and depth for socket size being used.
- Clean the hole thoroughly with brush and hand pump at least four times before installation.
- Insert cartridge into gun and attach nozzle.
- Dispense to waste until even colour is obtained.
- Insert the mixing nozzle to the far end of the hole and inject resin, slowly withdrawing the nozzle as the hole is filled to 70% of its depth.
- Immediately insert the socket, slowly and with slight twisting motion. Remove any excess resin around the hole before it sets and leave it undisturbed until the curing time elapses.
- Attach fixture and tighten the bolt to the required torque.

PRODUCT INFORMATION

Product Code	Resin	Description / Resin Type	Volume
			[ml]
R-KEX-II-385	R-KEX II	Epoxy Resin	385
R-KEX-II-600			600

SOCKETS

Size	Product Code		Anchor			Fixture
	Steel class 5.8	Steel grade A4	Socket diameter	Length	Internal thread length	Hole diameter
			d	L	l _s	d _f
M6	R-ITS-Z-06075	R-ITS-A4-06075	10	75	24	7
M8	R-ITS-Z-08075	R-ITS-A4-08075	12	75	25	9
	R-ITS-Z-08090	R-ITS-A4-08090	12	90	25	9
M10	R-ITS-Z-10075	R-ITS-A4-10075	16	75	30	12
	R-ITS-Z-10100	R-ITS-A4-10100	16	100	30	12
M12	R-ITS-Z-12100	R-ITS-A4-12100	16	100	35	14
M16	R-ITS-Z-16125	R-ITS-A4-16125	24	125	50	18

INSTALLATION DATA

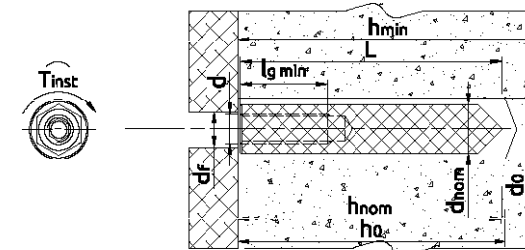

SOCKETS

Size		M6	M8	M10	M12	M16	
Min. installation depth	h _{nom} [mm]	75	75	90	75	100	125
Thread diameter	d [mm]	6	8	8	10	10	16
Hole diameter in substrate	d _o [mm]	12	14	14	20	20	28
Hole diameter in fixture	d _f [mm]	7	9	9	12	12	18
Thread engagement length	h _s [mm]	24	25	25	30	30	50
Min. hole depth in substrate	h _d [mm]	h _{nom} + 5	h _{nom} + 5	h _{nom} + 5	h _{nom} + 5	h _{nom} + 5	h _{nom} + 5
Min. substrate thickness	h _{min} [mm]	h _{nom} + 30 ≥ 100	h _{nom} + 30 ≥ 100	h _{nom} + 30 ≥ 100	h _{nom} + 30 ≥ 100	h _{nom} + 30 ≥ 100	h _{nom} + 30 ≥ 100
Installation torque	T _{inst} [Nm]	3	5	5	10	10	40
Min. spacing	s _{min} [mm]	40	40	50	40	50	70
Min. edge distance	c _{min} [mm]	40	40	50	40	50	70

Minimum working and curing time

Resin temperature	Concrete temperature	Curing time*	Working time
[°C]	[°C]	[min]	[min]
5	5	2880	150
10	10	1080	120
20	20	480	35
25	30	300	12

*For wet concrete the curing time must be doubled

R-KEX-II WITH INTERNALLY THREADED SOCKETS (ITS)

MECHANICAL PROPERTIES

Size		M6	M8	M10	M12	M16
R-ITS-Z Internally Threaded Sockets						
Nominal ultimate tensile strength - tension	F_{uk} [N/mm ²]	520	500	500	500	500
Nominal yield strength - tension	F_{yk} [N/mm ²]	420	400	400	400	400
Cross sectional area - tension	A_s [mm ²]	20.1	36.6	58	84.3	157
Elastic section modulus	W_{el} [mm ³]	21.21	50.3	98.2	169.7	402.1
R-ITS-A4 Internally Threaded Sockets						
Nominal ultimate tensile strength - tension	F_{uk} [N/mm ²]	700	700	700	700	700
Nominal yield strength - tension	F_{yk} [N/mm ²]	450	450	450	450	450
Cross sectional area - tension	A_s [mm ²]	20.1	36.6	58	84.3	157
Elastic section modulus	W_{el} [mm ³]	21.21	50.3	98.2	169.7	402.1
Metric Threaded Rods - Steel Class 5.8						
Characteristic bending resistance	$M_{Rk,s}^0$ [Nm]	8	19	37	65	166
Design bending resistance	M [Nm]	6	15	30	52	133
Allowable bending resistance	M_{rec} [Nm]	5	11	21	37	95
Metric Threaded Rods - Steel Class 8.8						
Characteristic bending resistance	$M_{Rk,s}^0$ [Nm]	12	30	60	105	266
Design bending resistance	M [Nm]	10	24	48	84	213
Allowable bending resistance	M_{rec} [Nm]	7	17	34	60	152
Metric Threaded Rods - A4						
Characteristic bending resistance	$M_{Rk,s}^0$ [Nm]	11	26	52	92	233
Design bending resistance	M [Nm]	7	17	34	59	149
Allowable bending resistance	M_{rec} [Nm]	5	12	24	42	107

BASIC PERFORMANCE DATA

SOCKETS

Performance data for single anchor without influence of edge distance and spacing

Size	M6	M8	M10	M12	M16	
Substrate	Non-cracked concrete					
Effective embedment depth h_{ef} [mm]	75.0	90.0	75.0	100.0	125.0	
MEAN ULTIMATE LOAD						
TENSION LOAD N_{Rum}						
METRIC THREADED RODS - STEEL CLASS 5.8	[kN]	12.50	21.600	21.6	34.80	34.80
METRIC THREADED RODS - STEEL CLASS 8.8	[kN]	19.20	34.80	34.80	50.60	55.20
METRIC THREADED RODS - A4	[kN]	16.80	31.20	31.20	49.20	49.20
SHEAR LOAD V_{Rum}						
METRIC THREADED RODS - STEEL CLASS 5.8	[kN]	6.00	10.80	10.80	16.80	16.80
METRIC THREADED RODS - STEEL CLASS 8.8	[kN]	9.60	18.00	18.00	27.60	27.60
METRIC THREADED RODS - A4	[kN]	8.40	15.60	15.60	24.00	24.00
CHARACTERISTIC LOAD						
TENSION LOAD N_{Rk}						
METRIC THREADED RODS - STEEL CLASS 5.8	[kN]	10.00	18.00	18.00	29.00	29.00
METRIC THREADED RODS - STEEL CLASS 8.8	[kN]	16.0	29.00	29.00	31.95	46.00
Steel failure	[kN]	14.0	-	-	-	-
METRIC THREADED RODS - A4	[kN]	-	25.0	25.0	31.95	40.0
SHEAR LOAD V_{Rk}						
METRIC THREADED RODS - STEEL CLASS 5.8	[kN]	5.00	9.20	9.20	14.50	14.50
METRIC THREADED RODS - STEEL CLASS 8.8	[kN]	8.00	14.60	14.60	23.20	23.20
METRIC THREADED RODS - A4	[kN]	7.00	12.80	12.80	20.30	20.30
DESIGN LOAD						
TENSION LOAD N_{Rd}						
METRIC THREADED RODS - STEEL CLASS 5.8	[kN]	6.67	12.00	12.00	17.75	17.75
METRIC THREADED RODS - STEEL CLASS 8.8	[kN]	10.47	17.75	19.33	17.75	27.33
Steel failure	[kN]	7.49	-	-	-	-
METRIC THREADED RODS - A4	[kN]	-	13.37	13.37	17.75	21.39
SHEAR LOAD V_{Rd}						
METRIC THREADED RODS - STEEL CLASS 5.8	[kN]	4.00	7.36	7.36	11.60	11.60
METRIC THREADED RODS - STEEL CLASS 8.8	[kN]	6.40	11.68	11.68	18.56	18.56
METRIC THREADED RODS - A4	[kN]	4.49	8.21	8.21	13.10	13.01
RECOMMENDED LOAD						
TENSION LOAD N_{rec}						
METRIC THREADED RODS - STEEL CLASS 5.8	[kN]	4.76	8.57	8.57	12.68	12.68
METRIC THREADED RODS - STEEL CLASS 8.8	[kN]	7.48	12.68	13.81	12.68	19.52
METRIC THREADED RODS - A4	[kN]	5.35	9.55	9.55	12.68	15.28
SHEAR LOAD V_{rec}						
METRIC THREADED RODS - STEEL CLASS 5.8	[kN]	2.86	5.26	5.26	8.29	8.29
METRIC THREADED RODS - STEEL CLASS 8.8	[kN]	4.57	8.34	8.34	13.26	13.26
METRIC THREADED RODS - A4	[kN]	3.21	5.86	5.86	9.29	9.29

R-KEX-II WITH INTERNALLY THREADED SOCKETS (ITS)

DESIGN PERFORMANCE DATA

SOCKETS

Size	M6	M8	M10	M12	M16	
Effective embedment depth	h_{ef} [mm]	75.00	75.00	90.00	75.00	100.00
TENSION LOAD						
STEEL FAILURE; STEEL CLASS 5.8						
Characteristic resistance	$N_{Rk,s}$ [kN]	10.00	18.00	18.00	29.00	29.00
Partial safety factor	γ_{Ms}	1.50	1.50	1.50	1.50	1.50
STEEL FAILURE; STEEL CLASS 8.8						
Characteristic resistance	$N_{Rk,s}$ [kN]	16.00	29.00	29.00	46.00	46.00
Partial safety factor	γ_{Ms}	1.50	1.50	1.50	1.50	1.50
STEEL FAILURE; STEEL GRADE A4-70						
Characteristic resistance	$N_{Rk,s}$ [kN]	14.00	25.00	25.00	40.00	40.00
Partial safety factor	γ_{Ms}	1.87	1.87	1.87	1.87	1.87
WORKING LIFE 50 YEARS						
COMBINED PULL-OUT AND CONCRETE CONE FAILURE; NON-CRACKED CONCRETE, C20/25 (40°C/24°C)						
Characteristic bond resistance	T_{Rk} [N/mm ²]	8.00	12.00	12.00	12.00	12.00
Sustained load factor	ψ_{sus}^0	0.75	0.75	0.75	0.75	0.75
COMBINED PULL-OUT AND CONCRETE CONE FAILURE; NON-CRACKED CONCRETE, C20/25 (80°C/50°C)						
Characteristic bond resistance	T_{Rk} [N/mm ²]	7.50	11.00	11.00	11.00	11.00
Sustained load factor	ψ_{sus}^0	0.72	0.72	0.72	0.72	0.72
WORKING LIFE 100 YEARS						
COMBINED PULL-OUT AND CONCRETE CONE FAILURE; NON-CRACKED CONCRETE, C20/25 (40°C/24°C)						
Characteristic bond resistance	T_{Rk} [N/mm ²]	8.00	12.00	12.00	12.00	12.00
Sustained load factor	ψ_{sus}^0	0.6	0.6	0.6	0.6	0.6
COMBINED PULL-OUT AND CONCRETE CONE FAILURE; NON-CRACKED CONCRETE, C20/25 (80°C/50°C)						
Characteristic bond resistance	T_{Rk} [N/mm ²]	7.50	11.00	11.00	11.00	11.00
Sustained load factor	ψ_{sus}^0	0.6	0.6	0.6	0.6	0.6
CONCRETE CONE FAILURE						
Installation safety factor	γ_2	1.20	1.20	1.20	1.20	1.20
Increasing factors for $N_{Rk,D} - C30/37$	ψ_c	1.04	1.04	1.04	1.04	1.04
Increasing factors for $N_{Rk,D} - C40/50$	ψ_c	1.07	1.07	1.07	1.07	1.07
Increasing factors for $N_{Rk,D} - C50/60$	ψ_c	1.09	1.09	1.09	1.09	1.09
CONCRETE SPLITTING FAILURE						
Installation safety factor	γ_2	1.20	1.20	1.20	1.20	1.20
SHEAR LOAD						
STEEL FAILURE; STEEL CLASS 5.8						
Characteristic resistance without lever arm	$V_{Rk,s}$ [kN]	6.00	11.00	11.00	17.00	17.00
Ductility factor	k_{τ}	1.0	1.0	1.0	1.0	1.0
Characteristic resistance with lever arm	$M_{Rk,s}$ [Nm]	7.60	18.70	18.70	37.40	37.40
Partial safety factor	γ_{Ms}	1.25	1.25	1.25	1.25	1.25
STEEL FAILURE; STEEL CLASS 8.8						
Characteristic resistance without lever arm	$V_{Rk,s}$ [kN]	8.00	14.60	14.60	23.20	23.20
Ductility factor	k_{τ}	1.0	1.0	1.0	1.0	1.0
Characteristic resistance with lever arm	$M_{Rk,s}$ [Nm]	12.20	30.00	30.00	59.80	59.80
Partial safety factor	γ_{Ms}	1.25	1.25	1.25	1.25	1.25
STEEL FAILURE; STEEL GRADE A4-70						
Characteristic resistance without lever arm	$V_{Rk,s}$ [kN]	7.00	12.80	12.80	20.30	20.30
Ductility factor	k_{τ}	1.0	1.0	1.0	1.0	1.0
Characteristic resistance with lever arm	$M_{Rk,s}$ [Nm]	10.70	26.20	26.20	52.30	52.30
Partial safety factor	γ_{Ms}	1.56	1.56	1.56	1.56	1.56
CONCRETE PRY-OUT FAILURE						
Factor	k	2.00	2.00	2.00	2.00	2.00
Installation safety factor	γ_2	1.00	1.00	1.00	1.00	1.00
CONCRETE EDGE FAILURE						
Anchor diameter	d_{nom} [mm]	10.00	12.00	12.00	16.00	16.00
Effective length of anchor	ℓ_f [mm]	min(300; $h_{ef}; 12d_{nom}$)	min(300; $h_{ef}; 12d_{nom}$)	min(300; $h_{ef}; 12d_{nom}$)	min(300; $h_{ef}; 12d_{nom}$)	min(300; $h_{ef}; 12d_{nom}$)
Installation safety factor	γ_2	1.00	1.00	1.00	1.00	1.00

Combined pull-out and concrete cone failure:
 (acc. TR 029, p.5.2.2.3. acc. to formula (5.2a) - $N_{Rk,D}^0 = n \cdot d \cdot h_{ef} \cdot \tau_{Rk}$
 acc. EN 1992-4, p.7.2.1.6. acc. to formula (7.14) - $N_{Rk,D}^0 = \psi_{sus} \cdot n \cdot d \cdot h_{ef} \cdot \tau_{Rk}$ where $\psi_{sus} = \psi_{sus}^0 + 1 - \alpha_{sus} \leq 1$ (7.14a,b)).
 Concrete cone failure:
 (acc. TR 029, p.5.2.2.4. acc. to formula (5.3a) - $N_{Rk,C}^0 = k_1 \cdot F_{dk,cube} \cdot h_{ef}^{1.5}$
 Acc. EN 1992-4, p.7.2.1.4. acc. to formula (7.2) - $N_{Rk,C}^0 = k_{ucr,N} \cdot F_{dk} \cdot h_{ef}^{1.5}$).

R-KER-II | R-CFS+KER-II WITH INTERNALLY THREADED SOCKETS (ITS)

High strength and versatile application in cracked and non-cracked concrete with internally threaded sockets (ITS)



FEATURES AND BENEFITS

- Approved for use in cracked and non-cracked concrete
- Allows removal of bolt to leave a re-usable socket in place
- Winter version can be used in warmer temperatures for faster curing
- Suitable for use in dry and wet substrates as well as holes and substrates covered with water
- Rapid bonding time enables quick execution of works
- Very high load capacity
- Anchor does not generate tensions in the substrate which enables R-KER to be specified where closer edge and spacing distances are required
- Suitable for multiple use. Partly used product can be reused after fitting new nozzle

APPLICATIONS

- Curtain walling
- Balustrading
- Handrails
- Canopies

BASE MATERIALS

- Approved for use in:
- Non-cracked concrete C20/25-C50/60
 - Cracked concrete C20/25-C50/60

INSTALLATION GUIDE

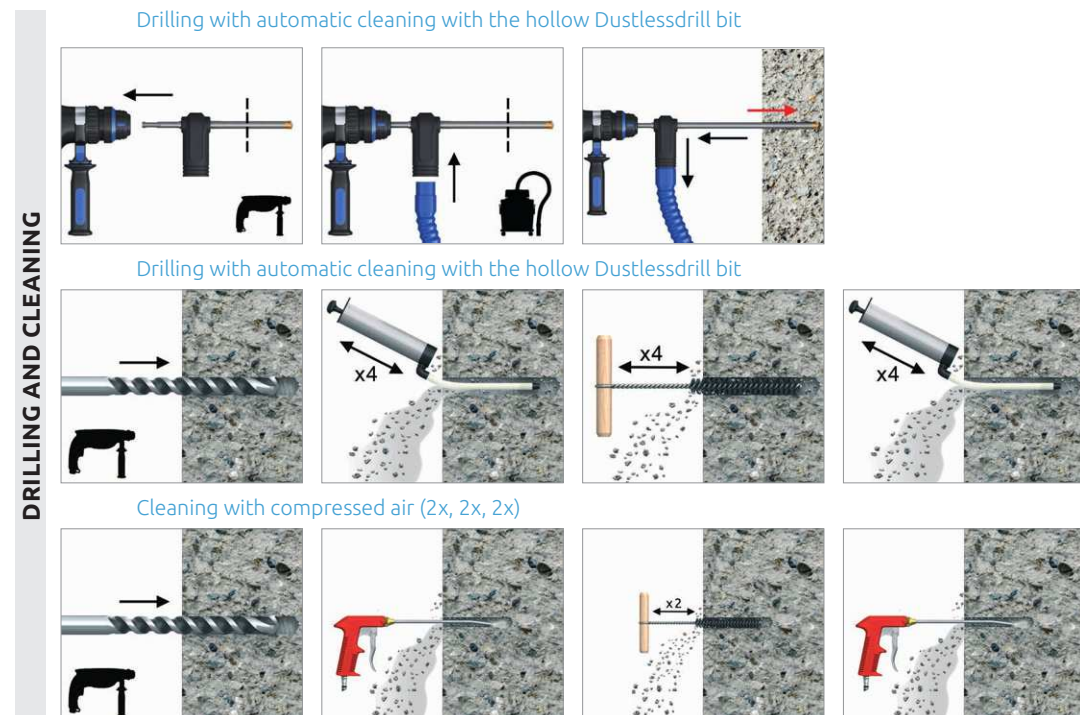

R-KER-II | R-CFS+KER-II WITH INTERNALLY THREADED SOCKETS (ITS)



- Drill hole to the required diameter and depth for socket size being used.
- Clean the drill hole thoroughly with brush and hand pump at least four times before installation
- Insert cartridge into gun and attach nozzle.
- Dispense to waste until even colour is obtained (min. 10 cm)
- Insert the mixer nozzle to the bottom of the drill hole and inject resin, slowly withdrawing the nozzle as the hole is filled to 70% of its depth.
- Immediately insert the socket, slowly and with slight twisting motion. Remove any excess resin around the hole before it sets and leave it undisturbed until the curing time elapses.
- Attach fixture and tighten the bolt to the required torque.

PRODUCT INFORMATION

	Product Code	Resin	Description / Resin Type	Volume
				[ml]
300ml	R-KER-II-300	R-KER-II	R-KER II Hybrid Resin	300
	R-KER-II-345			345
	R-KER-II-400			400
	R-KER-II-300-S			300
	R-KER-II-400-S	R-KER-II-S	R-KER II Hybrid Resin for High Temperature (Summer) / Slow Cure Styrene Free Hybrid Resin	400
	R-KER-II-300-W	R-KER-II-W	R-KER II Hybrid Resin for Low Temperature (Winter) / Rapid Cure Styrene Free Hybrid Resin	300
R-KER-II-400-W	400			
R-KER-II-400-SV	R-KER-II	R-KER II Hybrid Resin	300	
600ml	R-CFS+KERII-600	R-CFS+KERII	R-KER II Hybrid Resin	600
	R-CFS+KERII-600-S	R-CFS+KERII	R-KER II Hybrid Resin for High Temperature (Summer) / Slow Cure Styrene Free Hybrid Resin	600
	R-CFS+KERII-600-W	R-CFS+KERII	R-KER II Hybrid Resin for High Temperature (Winter) / Fast Cure Styrene Free Hybrid Resin	600

SOCKETS

Size	Product Code		Anchor			Fixture
	Steel class 5.8	Steel grade A4	Socket diameter	Length	Internal thread length	Hole diameter
			d [mm]	L [mm]	l _t [mm]	d _f [mm]
M6	R-ITS-Z-06075	R-ITS-A4-06075	10	75	24	7
M8	R-ITS-Z-08075	R-ITS-A4-08075	12	75	25	9
	R-ITS-Z-08090	R-ITS-A4-08090	12	90	25	9
M10	R-ITS-Z-10075	R-ITS-A4-10075	16	75	30	12
	R-ITS-Z-10100	R-ITS-A4-10100	16	100	30	12
M12	R-ITS-Z-12100	R-ITS-A4-12100	16	100	35	14
M16	R-ITS-Z-16125	R-ITS-A4-16125	24	125	50	18

R-KER-II | R-CFS+KER-II WITH INTERNALLY THREADED SOCKETS (ITS)

INSTALLATION DATA

SOCKETS

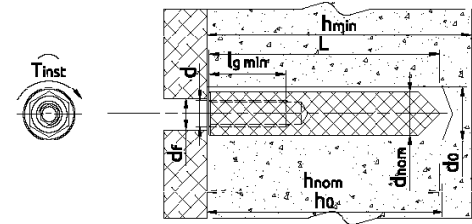

Size	M6	M8	M10	M12	M16
Min. installation depth	75	75	90	75	100
Thread diameter	6	8	8	10	12
Hole diameter in substrate	12	14	14	20	20
Hole diameter in fixture	7	9	9	12	14
Thread engagement length	24	25	25	30	35
Min. hole depth in substrate	$h_{nom} + 5$	$h_{nom} + 5$	$h_{nom} + 5$	$h_{nom} + 5$	$h_{nom} + 5$
Min. substrate thickness	$h_{nom} + 30 \geq 100$	$h_{nom} + 30 \geq 100$	$h_{nom} + 30 \geq 100$	$h_{nom} + 30 \geq 100$	$h_{nom} + 30 \geq 100$
Installation torque	3	5	5	10	20
Min. spacing	40	40	50	40	50
Min. edge distance	40	40	50	40	50

Minimum working and curing time

Resin temperature °C	Concrete temperature °C	Curing time* [min.]			Working time [min]		
		R-KER-II S	R-KER-II	R-KER-II W	R-KER-II S	R-KER-II	R-KER-II W
5	-20	-	-	24h	-	-	80
5	-15	-	-	16h	-	-	60
5	-10	-	-	8h	-	-	40
5	-5	-	1440	4h	-	40	20
5	0	-	180	2h	-	30	14
5	5	12h	90	60	40	15	9
10	10	8h	60	45	20	8	5.5
15	15	360	60	30	15	5	3
20	20	240	45	15	10	2.5	2
25	25	180	45	10	9.5	2	1.5
25	30	120	45	10	7	2	1.5
25	35	120	30	5	6.5	1.5	1
25	40	90	30	5	6.5	1.5	1

*For wet concrete the curing time must be doubled

MECHANICAL PROPERTIES

Size	M6	M8	M10	M12	M16	
R-ITS-Z Internally Threaded Sockets						
Nominal ultimate tensile strength - tension	F_{uk}	[N/mm ²]	520	500	500	500
Nominal yield strength - tension	F_{yk}	[N/mm ²]	420	400	400	400
Cross sectional area - tension	A_s	[mm ²]	20.1	36.6	58	84.3
Elastic section modulus	W_{el}	[mm ³]	21.21	50.3	98.2	169.7
R-ITS-A4 Internally Threaded Sockets						
Nominal ultimate tensile strength - tension	F_{uk}	[N/mm ²]	700	700	700	700
Nominal yield strength - tension	F_{yk}	[N/mm ²]	450	450	450	450
Cross sectional area - tension	A_s	[mm ²]	20.1	36.6	58	84.3
Elastic section modulus	W_{el}	[mm ³]	21.21	50.3	98.2	169.7
Metric Threaded Rods - Steel Class 5.8						
Characteristic bending resistance	$M_{Rk,s}$	[Nm]	8	19	37	65
Design bending resistance	M	[Nm]	6	15	30	52
Allowable bending resistance	M_{rec}	[Nm]	5	11	21	37
Metric Threaded Rods - Steel Class 8.8						
Characteristic bending resistance	$M_{Rk,s}$	[Nm]	12	30	60	105
Design bending resistance	M	[Nm]	10	24	48	84
Allowable bending resistance	M_{rec}	[Nm]	7	17	34	60
Metric Threaded Rods - A4						
Characteristic bending resistance	$M_{Rk,s}$	[Nm]	11	26	52	92
Design bending resistance	M	[Nm]	7	17	34	59
Allowable bending resistance	M_{rec}	[Nm]	5	12	24	42

R-KER-II | R-CFS+KER-II WITH INTERNALLY THREADED SOCKETS (ITS)

BASIC PERFORMANCE DATA

SOCKETS

Performance data for single anchor without influence of edge distance and spacing

Size	M6	M8	M10	M12	M16	M6	M8	M10	M12	M16					
Substrate	Non-cracked concrete					Cracked concrete									
Effective embedment depth h_{ef}	[mm]	75.0	90.0	75.0	100.0	125.0	75.0	90.0	75.0	100.0	125.0				
MEAN ULTIMATE LOAD															
TENSION LOAD N_{Rm}															
METRIC THREADED RODS - STEEL CLASS 5.8	[kN]	12.50	21.60	21.60	34.80	34.80	50.40	100.10	12.50	21.60	21.60	28.10	34.80	43.20	45.20
METRIC THREADED RODS - STEEL CLASS 8.8	[kN]	19.20	34.80	34.80	39.40	55.20	60.60	100.10	19.20	28.10	34.80	28.10	43.20	43.02	45.20
METRIC THREADED RODS - A4	[kN]	16.80	31.20	31.20	39.40	49.20	60.60	100.10	16.80	28.10	31.20	28.10	43.20	43.20	45.20
CHARACTERISTIC LOAD															
TENSION LOAD N_{Rk}															
METRIC THREADED RODS - STEEL CLASS 5.8	[kN]	10.00	18.00	18.00	29.00	29.00	42.00	68.75	10.00	18.00	18.00	22.37	29.00	34.44	37.70
METRIC THREADED RODS - STEEL CLASS 8.8	[kN]	16.00	29.00	29.00	31.95	46.00	49.19	68.75	16.00	22.37	29.00	22.37	34.44	34.44	37.70
METRIC THREADED RODS - A4	[kN]	14.00	25.00	25.00	32.80	40.00	49.19	68.75	14.00	22.37	25.00	22.37	34.44	34.44	37.70
CHARACTERISTIC LOAD															
SHEAR LOAD V_{Rk}															
METRIC THREADED RODS - STEEL CLASS 5.8	[kN]	5.00	9.20	9.20	14.50	14.50	21.10	39.30	5.00	9.20	9.20	14.50	14.50	21.10	39.30
METRIC THREADED RODS - STEEL CLASS 8.8	[kN]	8.00	14.60	14.60	23.20	23.20	33.70	62.80	8.00	14.60	14.60	23.20	23.20	33.70	62.80
METRIC THREADED RODS - A4	[kN]	7.00	12.80	12.80	20.30	20.30	29.50	55.00	7.00	12.80	12.80	20.30	20.30	29.50	55.00
DESIGN LOAD															
TENSION LOAD N_{Rd}															
METRIC THREADED RODS - STEEL CLASS 5.8	[kN]	6.67	12.00	12.00	19.33	19.33	28.00	45.83	6.67	12.00	12.00	14.91	19.33	22.96	25.13
METRIC THREADED RODS - STEEL CLASS 8.8	[kN]	10.67	19.33	19.33	21.30	30.67	32.80	45.83	10.67	14.91	19.33	14.91	22.96	22.96	25.13
METRIC THREADED RODS - A4	[kN]	7.49	13.37	13.37	21.30	21.39	31.55	45.83	7.49	13.37	13.37	14.91	22.96	22.96	25.13
DESIGN LOAD															
SHEAR LOAD V_{Rd}															
METRIC THREADED RODS - STEEL CLASS 5.8	[kN]	4.00	7.36	7.36	11.60	11.60	16.88	31.44	4.00	7.36	7.36	11.60	11.60	16.88	31.44
METRIC THREADED RODS - STEEL CLASS 8.8	[kN]	6.40	11.68	11.68	18.56	18.56	26.96	50.24	6.40	11.68	11.68	18.56	18.56	26.96	50.24
METRIC THREADED RODS - A4	[kN]	4.49	8.21	8.21	13.01	13.01	18.91	35.26	4.49	8.10	8.24	13.01	13.01	18.91	35.26
RECOMMENDED LOAD															
TENSION LOAD N_{rec}															
METRIC THREADED RODS - STEEL CLASS 5.8	[kN]	4.76	8.57	8.57	13.81	13.81	20.00	32.74	4.76	8.57	8.57	10.65	13.81	16.40	17.95
METRIC THREADED RODS - STEEL CLASS 8.8	[kN]	7.62	13.81	13.81	15.22	21.90	23.43	32.74	7.62	10.65	13.81	10.65	16.40	16.40	19.95
METRIC THREADED RODS - A4	[kN]	5.35	9.55	9.55	15.22	15.28	22.54	32.74	5.35	9.55	9.55	10.65	16.40	16.40	17.95
RECOMMENDED LOAD															
SHEAR LOAD V_{rec}															
METRIC THREADED RODS - STEEL CLASS 5.8	[kN]	2.86	5.26	5.26	8.29	8.29	12.06	22.46	2.86	5.26	5.26	8.29	8.29	12.6	22.46
METRIC THREADED RODS - STEEL CLASS 8.8	[kN]	4.57	8.34	8.34	13.26	13.26	19.26	35.89	4.57	8.34	8.34	13.26	13.26	19.26	35.89
METRIC THREADED RODS - A4	[kN]	3.21	5.86	5.86	9.29	9.29	13.51	25.18	3.21	5.86	5.86	9.29	9.29	13.51	25.18

DESIGN PERFORMANCE DATA

SOCKETS

Size	M6	M8	M10	M12	M16				
Effective embedment depth	h_{ef}	[mm]	75.00	75.00	90.00	75.00	100.00	100.00	125.00
TENSION LOAD									
STEEL FAILURE; STEEL CLASS 5.8									
Characteristic resistance	$N_{Rk,s}$	[kN]	10.00	18.00	18.00	29.00	29.00	42.00	78.00
Partial safety factor	γ_{Ms}	-	1.50	1.50	1.50	1.50	1.50	1.50	1.50
STEEL FAILURE; STEEL CLASS 8.8									
Characteristic resistance	$N_{Rk,s}$	[kN]	16.00	29.00	29.00	46.00	46.00	67.00	125.00
Partial safety factor	γ_{Ms}	-	1.50	1.50	1.50	1.50	1.50	1.50	1.50
STEEL FAILURE; STEEL GRADE A4-70									
Characteristic resistance	$N_{Rk,s}$	[kN]	14.00	25.00	25.00	40.00	40.00	59.00	109.00
Partial safety factor	γ_{Ms}	-	1.87	1.87	1.87	1.87	1.87	1.87	1.87
COMBINED PULL-OUT AND CONCRETE CONE FAILURE; NON-CRACKED CONCRETE, C20/25 (40°C/24°C)									
Characteristic bond resistance	T_{Rk}	[N/mm ²]	11.00	14.00	14.00	11.00	11.00	11.00	8.00

R-KER-II | R-CFS+KER-II WITH INTERNALLY THREADED SOCKETS (ITS)

DESIGN PERFORMANCE DATA (cont.)

Size			M6	M8	M10	M12	M16	
COMBINED PULL-OUT AND CONCRETE CONE FAILURE; NON-CRACKED CONCRETE, C20/25 (80°C/50°C)								
Characteristic bond resistance	T_{Rk}	[N/mm ²]	11.00	14.00	14.00	11.00	11.00	8.00
Effective embedment depth	h_{ef}	[mm]	75.00	75.00	90.00	75.00	100.00	125.00
TENSION LOAD								
STEEL FAILURE; STEEL CLASS 5.8								
Characteristic resistance	$N_{Rk,s}$	[kN]	10.00	18.00	18.00	29.00	29.00	78.00
Partial safety factor	γ_{Ms}	-	1.50	1.50	1.50	1.50	1.50	1.50
STEEL FAILURE; STEEL CLASS 8.8								
Characteristic resistance	$N_{Rk,s}$	[kN]	16.00	29.00	29.00	46.00	46.00	125.00
Partial safety factor	γ_{Ms}	-	1.50	1.50	1.50	1.50	1.50	1.50
STEEL FAILURE; STEEL GRADE A4-70								
Characteristic resistance	$N_{Rk,s}$	[kN]	14.00	25.00	25.00	40.00	40.00	109.00
Partial safety factor	γ_{Ms}	-	1.87	1.87	1.87	1.87	1.87	1.87
WORKING LIFE 50 YEARS								
COMBINED PULL-OUT AND CONCRETE CONE FAILURE; CRACKED CONCRETE, C20/25 (40°C/24°C)								
Characteristic bond resistance	T_{Rk}	[N/mm ²]	11.00	14.00	14.00	11.00	11.00	8.00
Sustained load factor	ψ_{sus}^0	-	0.72	0.72	0.72	0.72	0.72	0.72
COMBINED PULL-OUT AND CONCRETE CONE FAILURE; NON-CRACKED CONCRETE, C20/25 (80°C/50°C)								
Characteristic bond resistance	T_{Rk}	[N/mm ²]	11.00	14.00	14.00	11.00	11.00	8.00
Sustained load factor	ψ_{sus}^0	-	0.72	0.72	0.72	0.72	0.72	0.72
COMBINED PULL-OUT AND CONCRETE CONE FAILURE; NON-CRACKED CONCRETE, C20/25 (120°C/80°C)								
Characteristic bond resistance	T_{Rk}	[N/mm ²]	6.00	7.00	7.00	6.00	6.00	4.00
Sustained load factor	ψ_{sus}^0	-	0.61	0.61	0.61	0.61	0.61	0.61
COMBINED PULL-OUT AND CONCRETE CONE FAILURE; CRACKED CONCRETE, C20/25 (40°C/24°C)								
Characteristic bond resistance	T_{Rk}	[N/mm ²]	10.00	10.00	10.00	9.50	9.50	4.00
Sustained load factor	ψ_{sus}^0	-	0.72	0.72	0.72	0.72	0.72	0.72
COMBINED PULL-OUT AND CONCRETE CONE FAILURE; CRACKED CONCRETE, C20/25 (80°C/50°C)								
Characteristic bond resistance	T_{Rk}	[N/mm ²]	10.00	10.00	10.00	9.50	9.50	4.00
Sustained load factor	ψ_{sus}^0	-	0.72	0.72	0.72	0.72	0.72	0.72
COMBINED PULL-OUT AND CONCRETE CONE FAILURE; CRACKED CONCRETE, C20/25 (120°C/80°C)								
Characteristic bond resistance	T_{Rk}	[N/mm ²]	5.00	6.00	6.00	5.00	5.00	2.00
Sustained load factor	ψ_{sus}^0	-	0.61	0.61	0.61	0.61	0.61	0.61
WORKING LIFE 100 YEARS								
COMBINED PULL-OUT AND CONCRETE CONE FAILURE; CRACKED CONCRETE, C20/25 (40°C/24°C)								
Characteristic bond resistance	T_{Rk}	[N/mm ²]	10.00	13.00	13.00	10.00	10.00	8.00
Sustained load factor	ψ_{sus}^0	-	0.6	0.6	0.6	0.6	0.6	0.6
COMBINED PULL-OUT AND CONCRETE CONE FAILURE; NON-CRACKED CONCRETE, C20/25 (80°C/50°C)								
Characteristic bond resistance	T_{Rk}	[N/mm ²]	10.00	13.00	13.00	10.00	10.00	8.00
Sustained load factor	ψ_{sus}^0	-	0.6	0.6	0.6	0.6	0.6	0.6
COMBINED PULL-OUT AND CONCRETE CONE FAILURE; CRACKED CONCRETE, C20/25 (40°C/24°C)								
Characteristic bond resistance	T_{Rk}	[N/mm ²]	7.00	9.50	9.50	9.00	9.00	4.00
Sustained load factor	ψ_{sus}^0	-	0.6	0.6	0.6	0.6	0.6	0.6
COMBINED PULL-OUT AND CONCRETE CONE FAILURE; CRACKED CONCRETE, C20/25 (80°C/50°C)								
Characteristic bond resistance	T_{Rk}	[N/mm ²]	7.00	9.50	9.50	9.00	9.00	4.00
Sustained load factor	ψ_{sus}^0	-	0.6	0.6	0.6	0.6	0.6	0.6
COMBINED PULL-OUT AND CONCRETE CONE FAILURE								
Installation safety factor	γ_2	-	1.00	1.00	1.00	1.00	1.00	1.00
Increasing factors for $N_{Rk,p}$ - C30/37	ψ_c	-	1.04	1.04	1.04	1.04	1.04	1.00
Increasing factors for $N_{Rk,p}$ - C40/50	ψ_c	-	1.07	1.07	1.07	1.07	1.07	1.00
Increasing factors for $N_{Rk,p}$ - C50/60	ψ_c	-	1.09	1.09	1.09	1.09	1.09	1.00
CONCRETE CONE FAILURE								
Installation safety factor	γ_2	-	1.00	1.00	1.00	1.00	1.00	1.00
Factor for cracked concrete	$k_{cr,N}$	-	7.70	7.70	7.70	7.70	7.70	7.70
Factor for non-cracked concrete	$k_{ucr,N}$	-	11.00	11.00	11.00	11.00	11.00	11.00
Edge distance	$c_{cr,N}$	[mm]	1.50	1.50	1.50	1.50	1.50	1.50
Spacing	$s_{cr,N}$	[mm]	3.00	3.00	3.00	3.00	3.00	3.00
CONCRETE SPLITTING FAILURE								
Installation safety factor	γ_2	-	1.00	1.00	1.00	1.00	1.00	1.00

R-KER-II | R-CFS+KER-II WITH INTERNALLY THREADED SOCKETS (ITS)

DESIGN PERFORMANCE DATA (cont.)

Size			M6	M8	M10	M12	M16	
STEEL FAILURE; STEEL CLASS 5.8								
Characteristic resistance without lever arm	$V_{Rk,s}$	[kN]	5.00	9.20	9.20	14.50	14.50	39.30
Ductility factor	k_γ	-	0.8	0.8	0.8	0.8	0.8	0.8
Characteristic resistance with lever arm	$M_{Rk,s}$	[Nm]	7.60	18.70	18.70	37.40	37.40	166.50
Partial safety factor	γ_{Ms}	-	1.25	1.25	1.25	1.25	1.25	1.25
STEEL FAILURE; STEEL CLASS 8.8								
Characteristic resistance without lever arm	$V_{Rk,s}$	[kN]	8.00	14.60	14.60	23.20	23.20	62.80
Ductility factor	k_γ	-	0.8	0.8	0.8	0.8	0.8	0.8
Characteristic resistance with lever arm	$M_{Rk,s}$	[Nm]	12.20	30.00	30.00	59.80	59.80	266.40
Partial safety factor	γ_{Ms}	-	1.25	1.25	1.25	1.25	1.25	1.25
STEEL FAILURE; STEEL GRADE A4-70								
Characteristic resistance without lever arm	$V_{Rk,s}$	[kN]	7.00	12.80	12.80	20.30	20.30	55.00
Ductility factor	k_γ	-	0.8	0.8	0.8	0.8	0.8	0.8
Characteristic resistance with lever arm	$M_{Rk,s}$	[Nm]	10.70	26.20	26.20	52.30	52.30	233.10
Partial safety factor	γ_{Ms}	-	1.56	1.56	1.56	1.56	1.56	1.56
CONCRETE PRY-OUT FAILURE								
Factor	k	-	2.00	2.00	2.00	2.00	2.00	2.00
Installation safety factor	γ_2	-	1.00	1.00	1.00	1.00	1.00	1.00
CONCRETE EDGE FAILURE								
Anchor diameter	d_{nom}	[mm]	10.00	12.00	12.00	16.00	16.00	24.00
Effective length of anchor	ℓ_f	[mm]	min(300; $h_{ef} \cdot 12d_{nom}$)	min(300; $h_{ef} \cdot 12d_{nom}$)	min(300; $h_{ef} \cdot 12d_{nom}$)	min(300; $h_{ef} \cdot 12d_{nom}$)	min(300; $h_{ef} \cdot 12d_{nom}$)	min(300; $h_{ef} \cdot 12d_{nom}$)
Installation safety factor	γ_2	-	1.00	1.00	1.00	1.00	1.00	1.00

Combined pull-out and concrete cone failure:
 (acc. TR 029, p.5.2.2.3. acc. to formula (5.2a) – $N_{Rk,p}^0 = n \cdot d \cdot h_{ef} \cdot \tau_{Rk}$
 acc. EN 1992-4, p.7.2.1.6. acc. to formula (7.14) – $N_{Rk,p}^0 = \psi_{sus} \cdot n \cdot d \cdot h_{ef} \cdot \tau_{Rk}$ where $\psi_{sus} = \psi_{sus}^0 + 1 - \alpha_{sus} \leq 1$ (7.14a,b)).
 Concrete cone failure:
 (acc. TR 029, p.5.2.2.4. acc. to formula (5.3a) – $N_{Rk,c}^0 = k_1 \cdot f_{ck,cube}^{0.5} \cdot h_{ef}^{1.5}$
 Acc. EN 1992-4, p.7.2.1.4. acc. to formula (7.2) – $N_{Rk,c}^0 = k_{ucr,N} \cdot f_{ck}^{0.5} \cdot h_{ef}^{1.5}$).

R-KEX II WITH REBARS AS AN ANCHOR

premium pure epoxy resin approved for use with reinforcement bars



FEATURES AND BENEFITS

- Diamond and hammer drilling
- Seismic category C1
- The strongest resin in the epoxy resin class
- Approved for use in cracked and non-cracked concrete (EAD 330499-00-0601)
- Suitable for use in dry and wet substrates including flooded holes (use category I1 & I2)
- Very high chemical resistance – suitable for applications exposed to influence of various agents (industrial or marine environment)
- Minimal shrinkage provides option of use in diamond-drilled holes and oversized holes
- Extended working time ensures easy installation of metal components (up to 30 min. in 20°C)
- For use in positive temperatures

APPLICATIONS

- Safety barriers
- Temporary works/formworks support systems
- Rebar
- Curtain walling
- Formwork support systems
- Masonry support
- Platforms
- Structural steelwork
- Rebar dowelling
- Starter bars
- Rebar missed-outs

BASE MATERIALS

- Approved for use in:
- Non-cracked concrete C20/25-C50/60
 - Cracked concrete C20/25-C50/60
- Also suitable for use in:
- High-Density
 - Natural Stone

INSTALLATION GUIDE

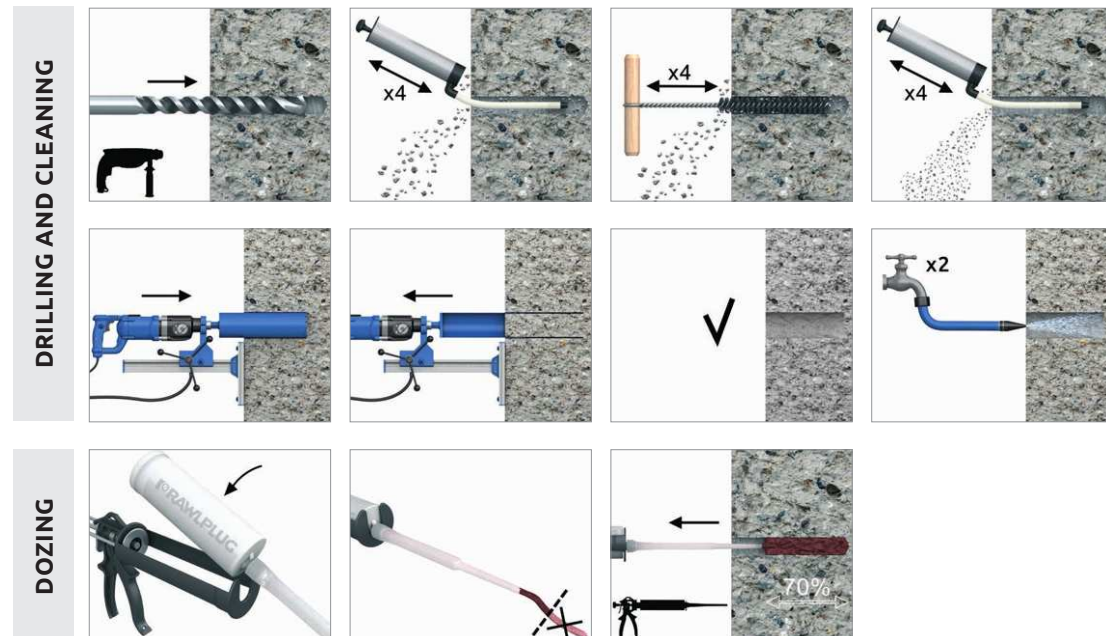

R-KEX II WITH REBARS AS AN ANCHOR

INSTALLATION GUIDE (cont.)

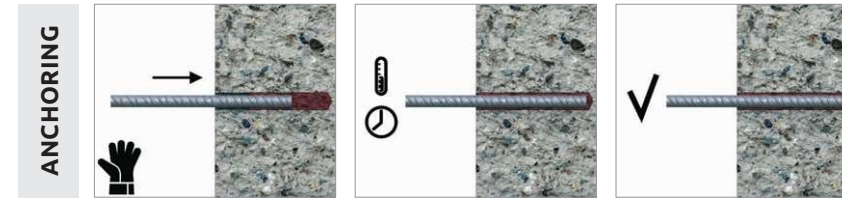

1. Drill hole to the required diameter and depth for rebar size being used.
2. Clean the hole with brush and hand pump at least four times each. It is very important and necessary before installation.
3. Insert cartridge into gun and attach nozzle.
4. Dispense to waste until even colour is obtained.
5. Insert the mixer nozzle to the bottom of the drill hole and inject resin, slowly withdrawing the nozzle as the hole is filled to 70% of its depth.
6. Immediately insert the rebar, slowly and with slight twisting motion. Remove any excess resin around the hole before it sets and leave it undisturbed until the curing time elapses.

PRODUCT INFORMATION

Product Code	Resin	Description / Resin Type	Volume
			[ml]
R-KEX-II-385	R-KEX II	Epoxy Resin	385
R-KEX-II-600			600

INSTALLATION DATA

REBARS AS ANCHORS

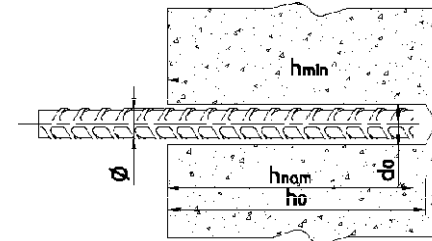

Size			Ø8	Ø10	Ø12	Ø14	Ø16	Ø20	Ø25	Ø32
Rebar diameter	d_s	[mm]	8	10	12	14	16	20	25	32
Hole diameter in substrate	d_o	[mm]	12	14	18	18	22	26	32	40
Min. hole depth in substrate	h_o	[mm]	$h_{nom} + 5$	$h_{nom} + 5$	$h_{nom} + 5$	$h_{nom} + 5$	$h_{nom} + 5$	$h_{nom} + 5$	$h_{nom} + 5$	$h_{nom} + 5$
Min. substrate thickness	h_{min}	[mm]	$h_{nom} + 30$ ≥ 100	$h_{nom} + 30$ ≥ 100	$h_{nom} + 30$ ≥ 100	$h_{nom} + 30$ ≥ 100	$h_{nom} + 2d_o$	$h_{nom} + 2d_o$	$h_{nom} + 2d_o$	$h_{nom} + 2d_o$
Min. spacing	s_{min}	[mm]	40	40	40	40	50	60	70	85
Min. edge distance	c_{min}	[mm]	40	40	40	40	50	60	70	85
MINIMUM EMBEDMENT DEPTH										
Min. installation depth	$h_{nom, min}$	[mm]	60	70	80	80	100	120	140	165
MAXIMUM EMBEDMENT DEPTH										
Min. installation depth	$h_{nom, max}$	[mm]	160	200	240	280	320	400	500	640

Minimum working and curing time

Resin temperature	Concrete temperature	Curing time*	Working time
[°C]	[°C]	[min]	[min]
5	5	2880	150
10	10	1080	120
20	20	480	35
25	30	300	12

*For wet concrete the curing time must be doubled

R-KEX II WITH REBAR AS AN ANCHOR

MECHANICAL PROPERTIES

REBARS AS ANCHORS

Size			Ø8	Ø10	Ø12	Ø14	Ø16	Ø20	Ø25	Ø32
f_{uk} = 540 (e.g. 500 B acc. to BS 4449; B 500 B acc. to SS 560)										
Nominal ultimate tensile strength - tension	F _{uk}	[N/mm ²]	540	540	540	540	540	540	540	540
Nominal yield strength - tension	F _{yk}	[N/mm ²]	500	500	500	500	500	500	500	500
Cross sectional area - tension	A _s	[mm ²]	50.3	78.5	113.1	153.9	153.9	314.2	490.9	804.2
Elastic section modulus	W _{el}	[mm ³]	50.3	98.2	170	402	402.1	785.4	1534	3217
f_{uk} = 575 (e.g. B 500 SP acc. to EC2)										
Nominal ultimate tensile strength - tension	F _{uk}	[N/mm ²]	575	575	575	575	575	575	575	575
Nominal yield strength - tension	F _{yk}	[N/mm ²]	500	500	500	500	500	500	500	500
Cross sectional area - tension	A _s	[mm ²]	50.3	78.5	113.1	153.9	153.9	314.2	490.9	804.2
Elastic section modulus	W _{el}	[mm ³]	50.3	98.2	170	402	402.1	785.4	1534	3217
f_{uk} = 620 (e.g. G-60 acc. to ASTM 615)										
Nominal ultimate tensile strength - tension	F _{uk}	[N/mm ²]	620	620	620	620	620	620	620	620
Nominal yield strength - tension	F _{yk}	[N/mm ²]	420	420	420	420	420	420	420	420
Cross sectional area - tension	A _s	[mm ²]	50.3	78.5	113.1	153.9	153.9	314.2	490.9	804.2
Elastic section modulus	W _{el}	[mm ³]	50.3	98.2	170	402	402.1	785.4	1534	3217

BASIC PERFORMANCE DATA

Size		Ø8	Ø10	Ø12	Ø14	Ø16	Ø20	Ø25	Ø32	Ø8	Ø10	Ø12	Ø14	Ø16	Ø20	Ø25	Ø32
Substrate		Non-cracked concrete								Cracked concrete							
MEAN ULTIMATE LOAD																	
TENSION LOAD N_{Ru,m}																	
f_{uk} = 540 (e.g. 500 B acc. to BS 4449; B 500 B acc. to SS 560)																	
Minimum embedment depth	[kN]	24.73	34.02	43.34	45.71	67.50	88.73	111.81	143.06	18.71	27.82	33.99	33.99	47.50	62.44	78.68	100.67
Maximum embedment depth	[kN]	28.50	44.53	61.13	87.28	114.00	178.13	278.33	456.01	28.50	44.53	64.13	87.28	114.00	178.13	278.33	456.01
f_{uk} = 575 (e.g. B 500 SP acc. to EC2)																	
Minimum embedment depth	[kN]	24.73	34.02	43.34	45.71	67.50	88.73	111.81	143.06	18.71	27.82	33.99	33.99	47.50	62.44	78.68	100.67
Maximum embedment depth	[kN]	30.55	47.42	68.28	92.94	121.39	189.67	296.37	485.56	30.55	47.42	68.28	92.94	121.38	189.67	296.37	485.56
f_{uk} = 620 (e.g. G-60 acc. to ASTM 615)																	
Minimum embedment depth	[kN]	24.73	34.02	43.34	45.71	67.50	88.73	111.81	143.06	18.71	27.82	33.99	33.99	47.50	62.44	78.68	100.67
Maximum embedment depth	[kN]	32.72	51.13	73.63	100.21	130.89	204.52	319.56	523.57	33.72	51.13	73.63	100.21	130.89	204.52	319.56	523.57
SHEAR LOAD V_{Ru,m}																	
f_{uk} = 540 (e.g. 500 B acc. to BS 4449; B 500 B acc. to SS 560)																	
Minimum embedment depth	[kN]	17.10	26.72	38.48	52.37	68.40	106.88	167.00	273.61	17.10	26.72	38.48	44.15	68.40	106.88	157.37	147.57
Maximum embedment depth	[kN]	17.1	26.72	38.48	52.37	68.04	106.88	167.00	273.61	17.10	26.72	38.48	52.37	68.40	106.88	167.00	273.61
f_{uk} = 575 (e.g. B 500 SP acc. to EC2)																	
Minimum embedment depth	[kN]	18.21	28.45	40.97	55.76	72.83	113.80	177.82	286.13	18.21	28.45	40.97	55.76	72.83	113.80	157.37	201.35
Maximum embedment depth	[kN]	18.21	28.545	40.97	55.76	72.83	113.80	177.82	291.34	18.21	28.45	40.97	55.76	72.83	113.80	177.82	291.34
f_{uk} = 620 (e.g. G-60 acc. to ASTM 615)																	
Minimum embedment depth	[kN]	19.63	30.68	44.18	60.13	78.53	122.71	191.74	286.13	19.63	30.68	44.18	60.13	78.53	122.71	157.37	201.35
Maximum embedment depth	[kN]	19.63	30.68	44.18	60.13	78.53	122.71	191.74	314.14	19.63	30.68	44.18	60.13	78.53	122.71	191.74	314.14
CHARACTERISTIC LOAD																	
TENSION LOAD N_{Rk}																	
f_{uk} = 540 (e.g. 500 B acc. to BS 4449; B 500 B acc. to SS 560)																	
Minimum embedment depth	[kN]	16.59	26.39	35.20	35.19	49.19	64.67	81.49	104.26	8.29	11.00	16.59	19.35	25.13	37.70	57.04	66.35
Maximum embedment depth	[kN]	27.14	42.41	61.07	83.13	108.57	169.65	265.07	434.29	22.12	31.42	49.76	67.73	80.42	125.66	215.98	257.36
f_{uk} = 575 (e.g. B 500 SP acc. to EC2)																	
Minimum embedment depth	[kN]	16.59	26.39	35.20	35.19	49.19	64.67	81.49	104.26	8.29	11.00	16.59	19.35	25.13	37.70	57.04	66.35
Maximum embedment depth	[kN]	28.9	45.2	65.0	88.5	115.6	180.6	282.3	462.4	22.12	31.42	49.76	67.73	80.42	125.66	215.98	257.36
f_{uk} = 620 (e.g. G-60 acc. to ASTM 615)																	
Minimum embedment depth	[kN]	16.59	26.39	35.20	35.19	49.19	64.67	81.49	104.26	8.29	11.00	16.59	19.35	25.13	37.70	57.04	66.35
Maximum embedment depth	[kN]	31.16	48.69	70.12	95.44	124.66	194.78	304.34	498.63	22.12	31.42	49.76	67.73	80.42	125.66	215.98	257.36

R-KEX II WITH REBAR AS AN ANCHOR

BASIC PERFORMANCE DATA (cont.)

Size		Ø8	Ø10	Ø12	Ø14	Ø16	Ø20	Ø25	Ø32	Ø8	Ø10	Ø12	Ø14	Ø16	Ø20	Ø25	Ø32
SHEAR LOAD V_{Rk}																	
f_{uk} = 540 (e.g. 500 B acc. to BS 4449; B 500 B acc. to SS 560)																	
Minimum embedment depth	[kN]	13.57	21.21	30.54	41.56	54.29	84.82	132.54	208.53	13.57	21.21	30.54	38.70	50.27	75.40	114.08	132.70
Maximum embedment depth	[kN]	13.57	21.21	30.54	41.56	54.29	84.82	132.54	217.15	13.57	21.21	30.54	41.56	54.29	84.82	132.54	217.15
f_{uk} = 575 (e.g. B 500 SP acc. to EC2)																	
Minimum embedment depth	[kN]	14.45	22.58	32.52	44.26	57.81	90.32	141.13	208.53	14.45	21.99	32.52	38.70	50.27	75.40	114.08	132.70
Maximum embedment depth	[kN]	14.45	22.58	32.52	44.26	57.81	90.32	141.13	231.22	14.45	22.58	32.52	44.26	57.81	90.32	141.13	231.23
f_{uk} = 620 (e.g. G-60 acc. to ASTM 615)																	
Minimum embedment depth	[kN]	15.58	24.35	35.06	46.94	62.33	97.37	152.17	208.53	15.58	21.99	33.18	38.70	50.27	75.40	114.08	132.70
Maximum embedment depth	[kN]	15.58	24.35	35.06	46.94	62.33	97.37	152.17	249.32	15.58	24.35	35.06	47.72	62.33	97.39	152.17	249.32
DESIGN LOAD																	
TENSION LOAD N_{Rd}																	
f_{uk} = 540 (e.g. 500 B acc. to BS 4449; B 500 B acc. to SS 560)																	
Minimum embedment depth	[kN]	9.22	14.66	19.56	19.55	27.33	35.93	45.27	57.92	4.61	6.11	9.22	10.75	13.96	20.94	31.69	36.86
Maximum embedment depth	[kN]	19.39	30.29	43.62	58.64	77.55	121.18	189.34	303.83	12.29	17.45	27.65	37.63	44.68	69.81	119.99	142.98
f_{uk} = 575 (e.g. B 500 SP acc. to EC2)																	
Minimum embedment depth	[kN]	9.22	14.66	19.56	19.55	27.33	35.93	45.27	57.92	4.61	6.11	9.22	10.75	13.96	20.94	31.69	36.86
Maximum embedment depth	[kN]	20.64	32.36	46.45	58.64	82.58	129.03	201.61	303.83	12.29	17.45	27.65	37.63	44.68	69.81	119.99	142.98
f_{uk} = 620 (e.g. G-60 acc. to ASTM 615)																	
Minimum embedment depth	[kN]	9.22	14.66	19.56	19.55	27.33	35.93	45.27	57.92	4.61	6.11	9.22	10.75	13.96	20.94	31.69	36.86
Maximum embedment depth	[kN]	22.26	34.78	50.09	58.64	89.04	139.13	207.26	303.83	12.29	17.45	27.65	37.63	44.68	69.81	119.99	142.98
SHEAR LOAD V_{Rd}																	
f_{uk} = 540 (e.g. 500 B acc. to BS 4449; B 500 B acc. to SS 560)																	
Minimum embedment depth	[kN]	9.05	14.14	20.36	27.71	36.19	56.55	88.36	139.02	9.05	14.14	20.36	25.08	33.51	50.27	76.06	88.47
Maximum embedment depth	[kN]	9.05	14.14	20.36	27.71	36.19	56.55	88.36	144.76	9.05	14.14	20.36	27.71	36.19	56.55	88.36	144.76
f_{uk} = 575 (e.g. B 500 SP acc. to EC2)																	
Minimum embedment depth	[kN]	9.63	15.05	21.68	29.50	38.54	60.21	94.08	139.02	9.63	14.66	21.68	25.80	33.51	50.27	76.06	88.47
Maximum embedment depth	[kN]	9.63	15.05	21.68	29.50	38.54	60.24	94.08	154.15	9.63	15.05	21.68	29.50	38.54	60.21	94.08	154.15
f_{uk} = 620 (e.g. G-60 acc. to ASTM 615)																	
Minimum embedment depth	[kN]	10.39	16.23	23.37	31.29	41.55	64.93	101.45	139.02	10.39	14.66	22.12	25.80	33.51	50.27	76.06	88.47
Maximum embedment depth	[kN]	10.39	16.23	23.37	31.81	41.55	64.93	101.45	166.21	10.39	16.23	23.37	31.81	41.55	64.93	101.45	166.21
RECOMMENDED LOAD																	
TENSION LOAD N_{rec}																	
f_{uk} = 540 (e.g. 500 B acc. to BS 4449; B 500 B acc. to SS 560)																	
Minimum embedment depth	[kN]	6.58	10.47	13.97	13.96	19.52	25.66	33.24	41.37	3.29	4.36	6.58	7.68	9.97	14.96	22.64	26.33
Maximum embedment depth	[kN]	13.85	21.64	31.16	41.89	55.39	86.55	135.24	217.02	8.78	12.47	19.75	26.88	31.91	49.87	85.71	102.13
f_{uk} = 575 (e.g. B 500 SP acc. to EC2)																	
Minimum embedment depth	[kN]	6.58	10.47	13.97	13.96	19.52	25.66	33.24	41.37	3.29	4.36	6.58	7.68	9.97	14.96	22.64	26.33
Maximum embedment depth	[kN]	14.75	23.04	33.18	41.89	58.99	92.16	144.01	217.02	8.78	12.47	19.75	26.88	31.91	49.87	85.71	102.13
f_{uk} = 620 (e.g. G-60 acc. to ASTM 615)																	
Minimum embedment depth	[kN]	6.58	10.47	13.97	13.96	19.52	25.66	32.34	41.37	3.29							

R-KEX II WITH REBAR AS AN ANCHOR

DESIGN PERFORMANCE DATA

REBARS AS ANCHORS

Size	Ø8	Ø10	Ø12	Ø14	Ø16	Ø20	Ø25	Ø32	
TENSION LOAD									
STEEL FAILURE; F_{UK} = 540 (E.G. 500 B ACC. TO BS 4449; B 500 B ACC. TO SS 560)									
Characteristic resistance	N _{Rk,s} [kN]	27.14	42.41	61.07	83.13	108.57	169.65	265.07	434.29
Partial safety factor	V _{M5}	1.40	1.40	1.40	1.40	1.40	1.40	1.40	1.40
STEEL FAILURE; F_{UK} = 575 (E.G. B 500 SP ACC. TO EC2)									
Characteristic resistance	N _{Rk,s} [kN]	28.90	45.16	65.03	88.51	115.61	180.64	282.25	462.44
Partial safety factor	V _{M5}	1.40	1.40	1.40	1.40	1.40	1.40	1.40	1.40
STEEL FAILURE; F_{UK} = 620 (E.G. G-60 ACC. TO ASTM 615)									
Characteristic resistance	N _{Rk,s} [kN]	31.16	48.69	70.12	95.44	124.66	194.78	304.34	498.63
Partial safety factor	V _{M5}	1.40	1.40	1.40	1.40	1.40	1.40	1.40	1.40
WORKING LIFE 50 YEARS									
COMBINED PULL-OUT AND CONCRETE CONE FAILURE; NON-CRACKED CONCRETE, C20/25 (40°C/24°C)									
Characteristic bond resistance	T _{Rk} [N/mm ²]	11.00	12.00	12.00	10.00	12.00	12.00	9.50	8.50
Sustained load factor	ψ ⁰ _{SUS}	0.75	0.75	0.75	0.75	0.75	0.75	0.75	0.75
COMBINED PULL-OUT AND CONCRETE CONE FAILURE; NON-CRACKED CONCRETE, C20/25 (80°C/50°C)									
Characteristic bond resistance	T _{Rk} [N/mm ²]	10.00	11.00	11.00	9.00	11.00	11.00	8.50	7.50
Sustained load factor	ψ ⁰ _{SUS}	0.72	0.72	0.72	0.72	0.72	0.72	0.72	0.72
COMBINED PULL-OUT AND CONCRETE CONE FAILURE; CRACKED CONCRETE, C20/25 (40°C/24°C)									
Characteristic bond resistance	T _{Rk} [N/mm ²]	5.50	5.00	5.50	5.50	5.00	5.00	5.50	4.00
Sustained load factor	ψ ⁰ _{SUS}	0.75	0.75	0.75	0.75	0.75	0.75	0.75	0.75
COMBINED PULL-OUT AND CONCRETE CONE FAILURE; CRACKED CONCRETE, C20/25 (80°C/50°C)									
Characteristic bond resistance	T _{Rk} [N/mm ²]	5.00	4.50	5.00	5.00	4.50	4.50	5.00	3.00
Sustained load factor	ψ ⁰ _{SUS}	0.72	0.72	0.72	0.72	0.72	0.72	0.72	0.72
WORKING LIFE 100 YEARS									
COMBINED PULL-OUT AND CONCRETE CONE FAILURE; NON-CRACKED CONCRETE, C20/25 (40°C/24°C)									
Characteristic bond resistance	T _{Rk} [N/mm ²]	11.00	12.00	12.00	10.00	12.00	12.00	9.50	8.50
Sustained load factor	ψ ⁰ _{SUS}	0.6	0.6	0.6	0.6	0.6	0.6	0.6	0.6
COMBINED PULL-OUT AND CONCRETE CONE FAILURE; NON-CRACKED CONCRETE, C20/25 (80°C/50°C)									
Characteristic bond resistance	T _{Rk} [N/mm ²]	10.00	11.00	11.00	9.00	11.00	11.00	8.50	7.50
Sustained load factor	ψ ⁰ _{SUS}	0.6	0.6	0.6	0.6	0.6	0.6	0.6	0.6
COMBINED PULL-OUT AND CONCRETE CONE FAILURE; CRACKED CONCRETE, C20/25 (40°C/24°C)									
Characteristic bond resistance	T _{Rk} [N/mm ²]	5.50	5.00	5.50	5.50	5.00	5.00	5.50	4.00
Sustained load factor	ψ ⁰ _{SUS}	0.6	0.6	0.6	0.6	0.6	0.6	0.6	0.6
COMBINED PULL-OUT AND CONCRETE CONE FAILURE; CRACKED CONCRETE, C20/25 (80°C/50°C)									
Characteristic bond resistance	T _{Rk} [N/mm ²]	5.00	4.50	5.00	5.00	4.50	4.50	5.00	3.00
Sustained load factor	ψ ⁰ _{SUS}	0.6	0.6	0.6	0.6	0.6	0.6	0.6	0.6
CONCRETE CONE FAILURE									
Installation safety factor	V ₂	-	1.20	1.20	1.20	1.20	1.20	1.20	1.20
Factor for cracked concrete	k _{cr,N}	-	7.70	7.70	7.70	7.70	7.70	7.70	7.70
Factor for non-cracked concrete	k _{ncr,N}	-	11.00	11.00	11.00	11.00	11.00	11.00	11.00
Edge distance	c _{cr,N} [mm]	1.50	1.50	1.50	1.50	1.50	1.50	1.50	1.50
Spacing	s _{cr,N} [mm]	3.00	3.00	3.00	3.00	3.00	3.00	3.00	3.00
CONCRETE SPLITTING FAILURE									
Installation safety factor	V ₂	-	1.20	1.20	1.20	1.20	1.20	1.20	1.20

R-KEX II WITH REBAR AS AN ANCHOR

DESIGN PERFORMANCE DATA (cont.)

Size	Ø8	Ø10	Ø12	Ø14	Ø16	Ø20	Ø25	Ø32	
SHEAR LOAD									
STEEL FAILURE; F_{UK} = 540 (E.G. 500 B ACC. TO BS 4449; B 500 B ACC. TO SS 560)									
Characteristic resistance without lever arm	V _{Rk,s} [kN]	13.57	21.21	30.54	41.56	54.29	84.82	132.54	217.15
Ductility factor	k _γ	1.00	1.00	1.00	1.00	1.00	1.00	1.00	1.00
Characteristic resistance with lever arm	M _{Rk,s} [Nm]	32.57	63.62	109.93	174.57	260.58	508.94	994.02	2084.61
Partial safety factor	V _{M5}	1.50	1.50	1.50	1.50	1.50	1.50	1.50	1.50
STEEL FAILURE; F_{UK} = 575 (E.G. B 500 SP ACC. TO EC2)									
Characteristic resistance without lever arm	V _{Rk,s} [kN]	14.45	22.59	32.52	44.26	57.81	90.32	141.13	231.22
Ductility factor	k _γ	1.00	1.00	1.00	1.00	1.00	1.00	1.00	1.00
Characteristic resistance with lever arm	M _{Rk,s} [Nm]	34.68	67.74	117.06	185.88	277.47	541.92	1058.45	2219.72
Partial safety factor	V _{M5}	1.50	1.50	1.50	1.50	1.50	1.50	1.50	1.50
STEEL FAILURE; F_{UK} = 620 (E.G. G-60 ACC. TO ASTM 615)									
Characteristic resistance without lever arm	V _{Rk,s} [kN]	15.58	24.35	35.06	47.72	62.33	97.39	152.17	249.32
Ductility factor	k _γ	1.00	1.00	1.00	1.00	1.00	1.00	1.00	1.00
Characteristic resistance with lever arm	M _{Rk,s} [Nm]	37.40	73.04	126.22	200.43	299.18	584.34	1141.28	2393.44
Partial safety factor	V _{M5}	1.50	1.50	1.50	1.50	1.50	1.50	1.50	1.50
CONCRETE PRY-OUT FAILURE									
Factor	k	-	2.00	2.00	2.00	2.00	2.00	2.00	2.00
Installation safety factor	V ₂	-	1.00	1.00	1.00	1.00	1.00	1.00	1.00
CONCRETE EDGE FAILURE									
Anchor diameter	d _{nom} [mm]	8.00	10.00	12.00	14.00	16.00	20.00	25.00	32.00
Effective length of anchor	ℓ _f [mm]	min(300; h _{ef} ·12d _{nom})	min(300; h _{ef} ·12d _{nom})	min(300; h _{ef} ·12d _{nom})	min(300; h _{ef} ·12d _{nom})	min(300; h _{ef} ·12d _{nom})	min(300; h _{ef} ·12d _{nom})	min(300; h _{ef} ·12d _{nom})	min(300; h _{ef} ·12d _{nom})
Installation safety factor	V ₂	-	1.00	1.00	1.00	1.00	1.00	1.00	1.00

Combined pull-out and concrete cone failure:
 (acc. TR 029, p.5.2.2.3. acc. to formula (5.2a) – $N_{Rk,D}^0 = n \cdot d \cdot h_{ef} \cdot \tau_{Rk}$
 acc. EN 1992-4, p.7.2.1.6. acc. to formula (7.14) – $N_{Rk,D}^0 = \psi_{SUS} \cdot n \cdot d \cdot h_{ef} \cdot \tau_{Rk}$ where $\psi_{SUS} = \psi^0 + 1 - \alpha_{SUS} \leq 1$ (7.14a,b)).
 Concrete cone failure:
 (acc. TR 029, p.5.2.2.4. acc. to formula (5.3a) – $N_{Rk,C}^0 = k_1 \cdot f_{ck,cube}^{0.5} \cdot h_{ef}^{1.5}$
 Acc. EN 1992-4, p.7.2.1.4. acc. to formula (7.2) – $N_{Rk,C}^0 = k_{ucr,N} \cdot f_{ck}^{0.5} \cdot h_{ef}^{1.5}$).

Allowable values for resistance in case of Seismic performance category C1

Size	Ø8	Ø10	Ø12	Ø14	Ø16	Ø20	Ø25	Ø32	
TENSION LOAD									
STEEL FAILURE; F_{UK} = 540 (E.G. 500 B ACC. TO BS 4449; B 500 B ACC. TO SS 560)									
Characteristic resistance	N _{Rk,s} [kN]	27.14	42.41	61.07	83.13	108.57	169.65	265.07	434.29
Partial safety factor	V _{M5N,seisC1}	1.40	1.40	1.40	1.40	1.40	1.40	1.40	1.40
STEEL FAILURE; F_{UK} = 575 (E.G. B 500 SP ACC. TO EC2)									
Characteristic resistance	N _{Rk,s} [kN]	28.90	45.16	65.03	88.51	115.61	180.64	282.25	462.44
Partial safety factor	V _{M5N,seisC1}	1.40	1.40	1.40	1.40	1.40	1.40	1.40	1.40
STEEL FAILURE; F_{UK} = 620 (E.G. G-60 ACC. TO ASTM 615)									
Characteristic resistance	N _{Rk,s} [kN]	31.16	48.69	70.12	94.44	124.66	194.78	304.34	498.63
Partial safety factor	V _{M5N,seisC1}	1.40	1.40	1.40	1.40	1.40	1.40	1.40	1.40
COMBINED PULL-OUT AND CONCRETE CONE FAILURE; CRACKED CONCRETE, C20/25 (40°C/24°C)									
Characteristic bond resistance	T _{Rk} [N/mm ²]	4.00	4.50	5.00	5.00	5.00	5.00	5.00	3.00
COMBINED PULL-OUT AND CONCRETE CONE FAILURE; CRACKED CONCRETE, C20/25 (80°C/50°C)									
Characteristic bond resistance	T _{Rk} [N/mm ²]	3.50	4.00	4.50	4.50	4.50	4.50	4.50	2.50
COMBINED PULL-OUT AND CONCRETE CONE FAILURE									
Characteristic bond resistance	T _{Rk} [N/mm ²]	1.20	1.20	1.20	1.20	1.20	1.20	1.20	1.20
SHEAR LOAD									
STEEL FAILURE; F_{UK} = 540 (E.G. 500 B ACC. TO BS 4449; B 500 B ACC. TO SS 560)									
Characteristic resistance	N _{Rk,s} [kN]	9.50	14.84	21.38	29.09	38.00	59.38	92.78	152.00
Partial safety factor	V _{M5N,seisC1}	1.50	1.50	1.50	1.50	1.50	1.50	1.50	1.50
STEEL FAILURE; F_{UK} = 575 (E.G. B 500 SP ACC. TO EC2)									
Characteristic resistance	N _{Rk,s} [kN]	10.12	15.81	22.76	30.98	40.46	63.22	98.79	161.85
Partial safety factor	V _{M5N,seisC1}	1.50	1.50	1.50	1.50	1.50	1.50	1.50	1.50
STEEL FAILURE; F_{UK} = 620 (E.G. G-60 ACC. TO ASTM 615)									
Characteristic resistance	N _{Rk,s} [kN]	10.91	17.04	24.51	33.40	43.63	68.17	106.52	174.52
Partial safety factor	V _{M5N,seisC1}	1.50	1.50	1.50	1.50	1.50	1.50	1.50	1.50

R-KEX-I REBAR AS ANCHOR

High performance pure epoxy resin approved for cracked and non-cracked concrete.
Available in Asia-Pacific region



FEATURES AND BENEFITS

- Approved for use in cracked and non-cracked concrete (EAD 330499-00-0601)
- Suitable for use in dry and wet substrates including flooded holes (use category I1 & I2)
- Very high chemical resistance – suitable for applications exposed to influence of various agents (industrial or marine environment)
- Minimal shrinkage provides option of use in diamond-drilled holes and oversized holes
- For use in positive temperatures
- High-performance epoxy resin for concrete.
- Installation direction D3 (downward and horizontal and upwards installation).
- Extended working time ensures easy installation of metal components (up to 50 min. in 20°C).
- Working with Dustlessdrill - drilling and hole cleaning in one step.
- Accessories dedicated for deep anchoring (brushes, extensions, piston plug, air adater and power guns)

APPLICATIONS

- Safety barriers
- Temporary works/formworks support systems
- Rebar
- Curtain walling
- Formwork support systems
- Masonry support
- Platforms
- Structural steelwork
- Rebar dowelling
- Starter bars
- Rebar missed-outs

BASE MATERIALS

- Approved for use in:
- Cracked concrete C20/25-C50/60
 - Non-cracked concrete C20/25-C50/60
- Also suitable for use in:
- High-Density Natural Stone

INSTALLATION GUIDE

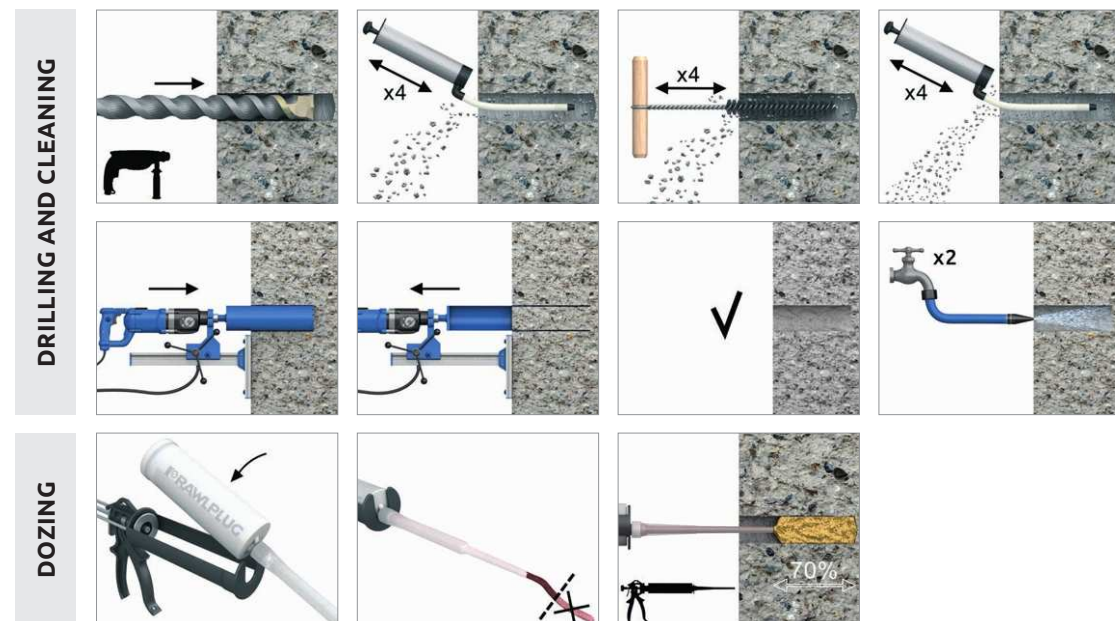

R-KEX-I REBAR AS ANCHOR

INSTALLATION GUIDE (cont.)



- Drill hole to the required diameter and depth for stud size being used.
- Clean the hole thoroughly with brush and hand pump at least four times before installation.
- Insert cartridge into gun and attach nozzle.
- Dispense to waste until even colour is obtained.
- Insert the mixing nozzle to the far end of the hole and inject resin, slowly withdrawing the nozzle as the hole is filled to 70% of its depth.
- Immediately insert the stud, slowly and with slight twisting motion. Remove any excess resin around the hole before it sets and leave it undisturbed until the curing time elapses.
- Attach fixture and tighten the nut to the required torque.

PRODUCT INFORMATION

Product Code	Resin	Description / Resin Type	Volume
			[ml]
R-KEX-I-600	R-KEX I	Epoxy Resin	600

INSTALLATION DATA

REBARS AS ANCHORS

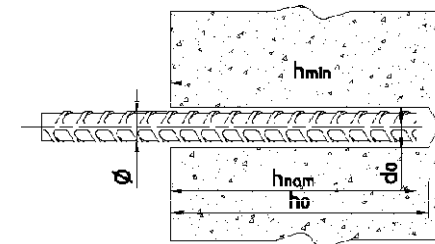

Size		Ø8	Ø10	Ø12	Ø14	Ø16	Ø20	Ø25	Ø32
Rebar diameter	d_s [mm]	8	10	12	14	16	20	25	32
Hole diameter in substrate	d_o [mm]	12	14	18	18	22	26	32	40
Min. hole depth in substrate	h_o [mm]	$h_{nom}+5$	$h_{nom}+5$	$h_{nom}+5$	$h_{nom}+5$	$h_{nom}+5$	$h_{nom}+5$	$h_{nom}+5$	$h_{nom}+5$
Min. substrate thickness	h_{min} [mm]	$h_{nom}+30$ ≥ 100	$h_{nom}+30$ ≥ 100	$h_{nom}+30$ ≥ 100	$h_{nom}+30$ ≥ 100	$h_{nom}+2d_o$	$h_{nom}+2d_o$	$h_{nom}+2d_o$	$h_{nom}+2d_o$
Min. spacing	s_{min} [mm]	40	40	40	40	50	60	70	85
Min. edge distance	c_{min} [mm]	40	40	40	40	50	60	70	85
MINIMUM EMBEDMENT DEPTH									
Min. installation depth	$h_{nom, min}$ [mm]	60	70	80	80	100	120	140	165
MAXIMUM EMBEDMENT DEPTH									
Min. installation depth	$h_{nom, max}$ [mm]	160	200	240	280	320	400	500	640

Minimum working and curing time

Resin temperature	Concrete temperature	Curing time*	Working time
[°C]	[°C]	[min]	[min]
5	5	96 h	180
10	10	72 h	120
20	20	10 h	35
25	30	5 h	20
25	40	4 h	20

* For wet concrete the curing time must be doubled

R-KEX-I REBAR AS ANCHOR

MECHANICAL PROPERTIES

REBARS AS ANCHORS

Size		Ø8	Ø10	Ø12	Ø16	Ø20	Ø25	Ø32
f_{uk} = 540 (e.g. 500 B acc. to BS 4449; B 500 B acc. to SS 560)								
Nominal ultimate tensile strength - tension	f _{yk}	[N/mm ²]	540	540	540	540	540	540
Nominal yield strength - tension	f _{yk}	[N/mm ²]	500	500	500	500	500	500
Cross sectional area - tension	A _s	[mm ²]	50	79	113	201	314	491
Elastic section modulus	W _{el}	[mm ³]	50	98	170	402	785	1534
f_{uk} = 575 (e.g. B 500 SP acc. to EC2)								
Nominal ultimate tensile strength - tension	f _{yk}	[N/mm ²]	575	575	575	575	575	575
Nominal yield strength - tension	f _{yk}	[N/mm ²]	500	500	500	500	500	500
Cross sectional area - tension	A _s	[mm ²]	50	79	113	201	314	491
Elastic section modulus	W _{el}	[mm ³]	50	98	170	402	785	1534
f_{uk} = 620 (e.g. G-60 acc. to ASTM 615)								
Nominal ultimate tensile strength - tension	f _{yk}	[N/mm ²]	620	620	620	620	620	620
Nominal yield strength - tension	f _{yk}	[N/mm ²]	420	420	420	420	420	420
Cross sectional area - tension	A _s	[mm ²]	50	79	113	201	314	491
Elastic section modulus	W _{el}	[mm ³]	50	98	170	402	785	1534

BASIC PERFORMANCE DATA

REBARS AS ANCHORS

Size	Ø8	Ø10	Ø12	Ø16	Ø20	Ø25	Ø32	Ø8	Ø10	Ø12	Ø16	Ø20	Ø25	Ø32
Substrate	Non-cracked concrete							Cracked concrete						
MEAN ULTIMATE LOAD														
TENSION LOAD N_{Rum}														
f_{uk} = 540 (e.g. 500 B acc. to BS 4449; B 500 B acc. to SS 560)														
Minimum embedment depth	[kN]	26.8	31.4	39.5	48.3	57.6	67.5	97.8	22.1	22.1	27.8	34.0	40.6	47.5
Maximum embedment depth	[kN]	28.5	44.5	64.1	114.0	178.1	287.3	456.0	28.5	44.5	64.1	114.0	178.1	278.3
f_{uk} = 575 (e.g. B 500 SP acc. to EC2)														
Minimum embedment depth	[kN]	26.8	31.4	39.5	48.3	57.6	67.5	97.8	22.1	22.1	27.8	34.0	40.6	47.5
Maximum embedment depth	[kN]	30.6	47.4	68.3	121.4	189.7	296.4	485.6	30.4	47.4	68.3	121.4	189.7	296.4
f_{uk} = 620 (e.g. G-60 acc. to ASTM 615)														
Minimum embedment depth	[kN]	26.8	31.4	39.5	48.3	57.6	67.5	97.8	22.1	22.1	27.8	34.0	40.6	47.5
Maximum embedment depth	[kN]	32.7	51.1	73.6	130.9	204.5	319.6	523.6	33.7	51.1	73.6	130.9	204.5	319.6
SHEAR LOAD V_{Rum}														
f_{uk} = 540 (e.g. 500 B acc. to BS 4449; B 500 B acc. to SS 560)														
Minimum embedment depth	[kN]	17.1	26.7	38.5	68.4	106.9	135.0	195.5	17.1	26.7	38.5	68.0	81.1	95.0
Maximum embedment depth	[kN]	17.1	26.7	38.5	68.4	106.9	167.0	273.6	17.1	26.7	38.5	68.4	106.9	167.0
f_{uk} = 575 (e.g. B 500 SP acc. to EC2)														
Minimum embedment depth	[kN]	18.2	28.5	41.0	72.8	113.8	135.0	195.5	18.2	28.5	41.0	68.0	81.1	95.0
Maximum embedment depth	[kN]	18.2	28.5	41.0	72.8	113.8	177.8	291.3	18.2	28.5	41.0	72.8	113.8	177.8
f_{uk} = 620 (e.g. G-60 acc. to ASTM 615)														
Minimum embedment depth	[kN]	19.6	30.7	44.2	78.5	115.3	135.0	195.5	19.6	30.7	44.2	68.0	81.1	95.0
Maximum embedment depth	[kN]	19.6	30.7	44.2	78.5	122.7	191.7	314.1	19.6	30.7	44.2	78.5	122.7	191.7
CHARACTERISTIC LOAD														
TENSION LOAD N_{Rk}														
f_{uk} = 540 (e.g. 500 B acc. to BS 4449; B 500 B acc. to SS 560)														
Minimum embedment depth	[kN]	22.6	22.9	28.8	35.2	42.0	49.2	71.2	9.80	12.3	18.5	24.6	29.4	34.4
Maximum embedment depth	[kN]	27.1	42.4	61.1	108.6	169.7	265.1	434.3	26.1	40.8	61.1	108.6	169.7	196.4
f_{uk} = 575 (e.g. B 500 SP acc. to EC2)														
Minimum embedment depth	[kN]	22.6	22.9	28.8	35.2	42.0	49.2	71.2	9.80	12.3	18.5	24.6	29.4	34.4
Maximum embedment depth	[kN]	28.9	45.2	65.0	115.6	180.6	282.3	462.4	26.1	40.8	63.3	112.6	175.9	196.4
f_{uk} = 620 (e.g. G-60 acc. to ASTM 615)														
Minimum embedment depth	[kN]	22.6	22.9	28.8	35.2	42.0	49.2	71.2	9.80	12.3	18.5	24.6	29.4	34.4
Maximum embedment depth	[kN]	31.2	48.7	70.1	124.7	194.8	304.3	498.6	26.1	40.8	63.3	112.6	175.9	196.4
SHEAR LOAD V_{Rk}														
f_{uk} = 540 (e.g. 500 B acc. to BS 4449; B 500 B acc. to SS 560)														
Minimum embedment depth	[kN]	13.6	21.2	30.5	54.3	84.0	98.4	142.5	13.6	21.2	30.5	49.3	58.8	68.9
Maximum embedment depth	[kN]	13.6	21.2	30.5	54.3	84.8	132.5	217.2	13.6	21.2	30.5	54.3	84.8	132.5
f_{uk} = 575 (e.g. B 500 SP acc. to EC2)														
Minimum embedment depth	[kN]	14.5	22.6	32.5	57.8	84.0	98.4	142.5	14.5	22.6	32.5	49.3	58.8	68.9
Maximum embedment depth	[kN]	14.5	22.6	32.5	57.8	90.3	141.1	231.2	14.5	22.6	32.5	57.8	90.3	141.1
f_{uk} = 620 (e.g. G-60 acc. to ASTM 615)														
Minimum embedment depth	[kN]	15.6	24.4	35.1	62.3	84.0	98.4	142.5	15.6	22.0	35.1	49.3	58.8	68.9
Maximum embedment depth	[kN]	15.6	24.4	35.1	62.3	97.4	152.2	249.3	15.6	24.4	35.1	62.3	97.4	152.2

R-KEX-I REBAR AS ANCHOR

BASIC PERFORMANCE DATA (cont.)

Size	Ø8	Ø10	Ø12	Ø16	Ø20	Ø25	Ø32	Ø8	Ø10	Ø12	Ø16	Ø20	Ø25	Ø32
DESIGN LOAD														
TENSION LOAD N_{rd}														
f_{uk} = 540 (e.g. 500 B acc. to BS 4449; B 500 B acc. to SS 560)														
Minimum embedment depth	[kN]	15.1	15.2	19.2	23.5	28.0	32.8	47.5	6.53	8.17	12.3	16.4	19.6	23.0
Maximum embedment depth	[kN]	19.4	30.3	43.6	77.6	121.2	189.3	310.2	17.4	27.2	42.2	75.1	117.3	130.9
f_{uk} = 575 (e.g. B 500 SP acc. to EC2)														
Minimum embedment depth	[kN]	15.1	15.2	19.2	23.5	28.0	32.8	47.5	6.53	8.17	12.3	16.4	19.6	23.0
Maximum embedment depth	[kN]	20.6	32.3	46.5	82.6	129.0	201.6	330.3	17.4	27.2	42.2	75.1	117.3	130.9
f_{uk} = 620 (e.g. G-60 acc. to ASTM 615)														
Minimum embedment depth	[kN]	15.1	15.2	19.2	23.5	28.0	32.8	47.5	6.53	8.17	12.3	16.4	19.6	23.0
Maximum embedment depth	[kN]	22.3	34.8	50.1	89.0	139.1	217.4	356.2	17.4	27.2	42.2	75.1	117.3	130.9
SHEAR LOAD V_{rd}														
f_{uk} = 540 (e.g. 500 B acc. to BS 4449; B 500 B acc. to SS 560)														
Minimum embedment depth	[kN]	9.05	14.1	20.4	36.2	56.0	65.6	95.0	9.05	14.1	20.4	32.9	39.2	45.9
Maximum embedment depth	[kN]	9.05	14.1	20.4	36.2	56.6	88.4	144.8	9.05	14.1	20.4	36.2	56.6	88.4
f_{uk} = 575 (e.g. B 500 SP acc. to EC2)														
Minimum embedment depth	[kN]	9.63	15.1	21.7	38.5	56.0	65.6	95.0	9.63	14.7	21.7	32.9	39.2	45.9
Maximum embedment depth	[kN]	9.63	15.1	21.7	38.5	60.2	94.1	154.2	9.63	15.1	21.7	38.5	60.2	94.1
f_{uk} = 620 (e.g. G-60 acc. to ASTM 615)														
Minimum embedment depth	[kN]	10.4	16.2	23.4	41.6	56.0	65.6	95.0	10.4	14.7	23.4	32.9	39.2	45.9
Maximum embedment depth	[kN]	10.4	16.2	23.4	41.6	64.9	101.5	166.2	10.4	16.2	23.4	41.6	64.9	101.5
RECOMMENDED LOAD														
TENSION LOAD N_{rec}														
f_{uk} = 540 (e.g. 500 B acc. to BS 4449; B 500 B acc. to SS 560)														
Minimum embedment depth	[kN]	10.8	10.9	13.7	16.8	20.0	23.4	33.9	4.67	5.83	8.00	11.7	14.0	16.4
Maximum embedment depth	[kN]	13.9	21.6	31.2	55.4	86.6	135.2	221.6	12.5	19.5	30.2	53.6	83.8	93.5
f_{uk} = 575 (e.g. B 500 SP acc. to EC2)														
Minimum embedment depth	[kN]	10.8	10.9	13.7	16.8	20.0	23.4	33.9	4.67	5.83	8.00	11.7	14.0	16.4
Maximum embedment depth	[kN]	14.8	23.0	33.2	59.0	92.2	144.0	235.9	12.5	19.5	30.2	53.6	83.8	93.5
f_{uk} = 620 (e.g. G-60 acc. to ASTM 615)														
Minimum embedment depth	[kN]	10.8	10.9	13.7	16.8	20.0	23.4	33.9	4.67	5.83	8.00	11.7	14.0	16.4
Maximum embedment depth	[kN]	15.9	24.8	35.8	63.6	99.4	155.3	254.0	12.5	19.5	30.2	53.6	83.8	93.5
SHEAR LOAD V_{rec}														
f_{uk} = 540 (e.g. 500 B acc. to BS 4449; B 500 B acc. to SS 560)														
Minimum embedment depth	[kN]	6.46	10.1	14.5	25.9	40.0	46.9	67.9	6.46	10.1	14.5	23.5	28.0	32.8
Maximum embedment depth	[kN]	6.46	10.1	14.5	25.9	40.4	63.1	103.4	6.46	10.1	14.5	25.9	40.4	63.1
f_{uk} = 575 (e.g. B 500 SP acc. to EC2)														
Minimum embedment depth	[kN]	6.88	10.8	15.5	27.5	40.0	46.9	67.9	6.88	10.5	15.5	23.5	28.0	32.8
Maximum embedment depth	[kN]	6.88	10.8	15.5	27.5	43.0	67.2	110.1	6.88	10.8	15.5	27.5	43.0	67.2
f_{uk} = 620 (e.g. G-60 acc. to ASTM 615)														
Minimum embedment depth	[kN]	7.42	11.6	16.7	29.7	40.0	46.9	67.9	7.42	10.5	16.7	23.5	28.0	32.8
Maximum embedment depth	[kN]	7.42	11.6	16.7	29.7	46.4	72.5	118.7	7.42	11.6	16.7	29.7	46.4	72.5

DESIGN PERFORMANCE DATA

REBARS AS ANCHORS

Size	Ø8	Ø10	Ø12	Ø16	Ø20	Ø25	Ø32
TENSION LOAD							
STEEL FAILURE; F_{UK} = 540 (E.G. 500 B ACC. TO BS 4449; B 500 B ACC. TO SS 560)							
Characteristic resistance	N _{Rk,s}	[kN]	27.14	42.41	61.07	108.57	169.65
Partial safety factor	γ _{Ms}	-	1.40	1.40	1.40	1.40	1.40
STEEL FAILURE; F_{UK} = 575 (E.G. B 500 SP ACC. TO EC2)							
Characteristic resistance	N _{Rk,s}	[kN]	28.90	45.16	65.03	115.61	180.64
Partial safety factor	γ _{Ms}	-	1.40	1.40	1.40	1.40	1.40
STEEL FAILURE; F_{UK} = 620 (E.G. G-60 ACC. TO ASTM 615)							
Characteristic resistance	N _{Rk,s}	[kN]	31.16	48.69	70.12	12	

R-KEX-I REBAR AS ANCHOR

DESIGN PERFORMANCE DATA (cont.)

Size			Ø8	Ø10	Ø12	Ø16	Ø20	Ø25	Ø32
COMBINED PULL-OUT AND CONCRETE CONE FAILURE; NON-CRACKED CONCRETE, C20/25 (40°C/24°C)									
Characteristic bond resistance	T_{Rk}	[N/mm ²]	15.00	14.00	14.00	10.00	10.00	10.00	9.00
Sustained load factor	ψ_{sus}^0	-	0.60	0.60	0.60	0.60	0.60	0.60	0.60
COMBINED PULL-OUT AND CONCRETE CONE FAILURE; NON-CRACKED CONCRETE, C20/25 (80°C/50°C)									
Characteristic bond resistance	T_{Rk}	[N/mm ²]	15.00	14.00	14.00	10.00	10.00	10.00	9.00
Sustained load factor	ψ_{sus}^0	-	0.60	0.60	0.60	0.60	0.60	0.60	0.60
COMBINED PULL-OUT AND CONCRETE CONE FAILURE; CRACKED CONCRETE, C20/25 (40°C/24°C)									
Characteristic bond resistance	T_{Rk}	[N/mm ²]	6.50	6.50	7.00	7.00	7.00	5.00	4.50
Sustained load factor	ψ_{sus}^0	-	0.60	0.60	0.60	0.60	0.60	0.60	0.60
COMBINED PULL-OUT AND CONCRETE CONE FAILURE; CRACKED CONCRETE, C20/25 (80°C/50°C)									
Characteristic bond resistance	T_{Rk}	[N/mm ²]	6.50	6.50	7.00	7.00	7.00	5.00	4.50
Sustained load factor	ψ_{sus}^0	-	0.60	0.60	0.60	0.60	0.60	0.60	0.60
COMBINED PULL-OUT AND CONCRETE CONE FAILURE									
Installation safety factor	γ_2	-	1.00	1.00	1.00	1.00	1.00	1.00	1.00
Increasing factors for $N_{rd,p}$ - C30/37	ψ_c	-	1.04	1.04	1.04	1.04	1.04	1.04	1.04
Increasing factors for $N_{rd,p}$ - C40/50	ψ_c	-	1.07	1.07	1.07	1.07	1.07	1.07	1.07
Increasing factors for $N_{rd,p}$ - C50/60	ψ_c	-	1.09	1.09	1.09	1.09	1.09	1.09	1.09
CONCRETE CONE FAILURE									
Installation safety factor	γ_2	-	1.00	1.00	1.00	1.00	1.00	1.00	1.00
Factor for cracked concrete	$k_{cr,N}$	-	7.70	7.70	7.70	7.70	7.70	7.70	7.70
Factor for non-cracked concrete	$k_{ucr,N}$	-	11.00	11.00	11.00	11.00	11.00	11.00	11.00
Edge distance	$c_{cr,N}$	[mm]	1.5*h _{ef}	1.5*h _{ef}	1.5*h _{ef}	1.5*h _{ef}	1.5*h _{ef}	1.5*h _{ef}	1.5*h _{ef}
Spacing	$s_{cr,N}$	[mm]	3.0*h _{ef}	3.0*h _{ef}	3.0*h _{ef}	3.0*h _{ef}	3.0*h _{ef}	3.0*h _{ef}	3.0*h _{ef}
CONCRETE SPLITTING FAILURE									
Installation safety factor	γ_2	-	1.00	1.00	1.00	1.00	1.00	1.00	1.00
STEEL FAILURE; F_{UK} = 540 (E.G. 500 B ACC. TO BS 4449; B 500 B ACC. TO SS 560)									
Characteristic resistance without lever arm	$V_{Rk,s}$	[kN]	13.57	21.21	30.54	54.29	84.82	132.54	217.15
Ductility factor	k_γ	-	0.80	0.80	0.80	0.80	0.80	0.80	0.80
Characteristic resistance with lever arm	$M_{Rk,s}$	[Nm]	32.57	63.62	109.93	260.58	508.94	994.02	2084.61
Partial safety factor	γ_{Ms}	-	1.50	1.50	1.50	1.50	1.50	1.50	1.50
STEEL FAILURE; F_{UK} = 575 (E.G. B 500 SP ACC. TO EC2)									
Characteristic resistance without lever arm	$V_{Rk,s}$	[kN]	14.45	22.59	32.52	57.81	90.32	141.13	231.22
Ductility factor	k_γ	-	0.80	0.80	0.80	0.80	0.80	0.80	0.80
Characteristic resistance with lever arm	$M_{Rk,s}$	[Nm]	34.68	67.74	117.06	277.47	541.92	1058.45	2219.72
Partial safety factor	γ_{Ms}	-	1.50	1.50	1.50	1.50	1.50	1.50	1.50
STEEL FAILURE; F_{UK} = 620 (E.G. G-60 ACC. TO ASTM 615)									
Characteristic resistance without lever arm	$V_{Rk,s}$	[kN]	15.58	24.35	35.06	62.33	97.39	152.17	249.32
Ductility factor	k_γ	-	0.80	0.80	0.80	0.80	0.80	0.80	0.80
Characteristic resistance with lever arm	$M_{Rk,s}$	[Nm]	37.40	73.04	126.22	299.18	584.34	1141.28	2393.44
Partial safety factor	γ_{Ms}	-	1.50	1.50	1.50	1.50	1.50	1.50	1.50
CONCRETE PRY-OUT FAILURE									
Factor	k	-	2.00	2.00	2.00	2.00	2.00	2.00	2.00
Installation safety factor	γ_2	-	1.00	1.00	1.00	1.00	1.00	1.00	1.00
CONCRETE EDGE FAILURE									
Anchor diameter	d_{nom}	[mm]	8.00	10.00	12.00	16.00	20.00	25.00	32.00
Effective length of anchor	l_t	[mm]	min(300; h _{ef} ; 12d _{nom})	min(300; h _{ef} ; 12d _{nom})	min(300; h _{ef} ; 12d _{nom})	min(300; h _{ef} ; 12d _{nom})	min(300; h _{ef} ; 12d _{nom})	min(300; h _{ef} ; 12d _{nom})	min(300; h _{ef} ; 12d _{nom})
Installation safety factor	γ_2	-	1.00	1.00	1.00	1.00	1.00	1.00	1.00

Combined pull-out and concrete cone failure:
 (EN 1992-4:2018, p.7.2.1.6., 7.14 - $N_{Rk,p}^0 = \psi_{sus}^0 * \tau_{Rk} * n * d * h_{ef}$),
 $h_{ef} = h_{nom}$

R-KER-II | R-CFS+KER-II WITH REBAR AS AN ANCHOR

High performance hybrid resin approved for use with reinforcement bars



FEATURES AND BENEFITS

- Approved for use with rebar as an anchor in cracked and non-cracked concrete
- Winter version can be used in warmer temperatures for faster curing
- Suitable for use in dry and wet substrates as well as holes and substrates covered with water
- Rapid bonding time enables quick execution of works
- Very high load capacity
- Anchor does not generate expansion forces in the concrete which means reduced spacing and edge distances.
- Suitable for multiple use. Partly used product can be reused after fitting new nozzle

APPLICATIONS

- Curtain walling
- Balustrading
- Barriers
- Cable trays
- Cladding restraints
- Structural steelwork
- Rebar dowelling
- Starter bars
- Rebar missed-outs

BASE MATERIALS

- Approved for use in:
- Non-cracked concrete C20/25-C50/60
 - Cracked concrete C20/25-C50/60

INSTALLATION GUIDE

Drilling with automatic cleaning with the hollow Dustlessdrill bit

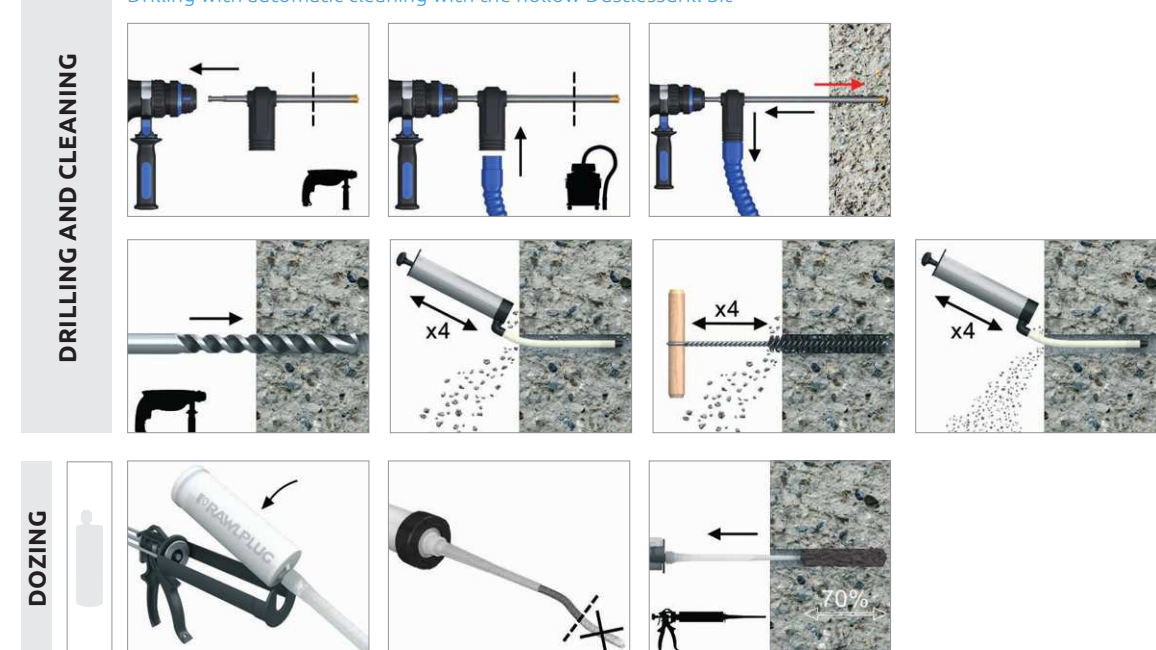

R-KER-II | R-CFS+KER-II WITH REBAR AS AN ANCHOR

INSTALLATION GUIDE (cont.)

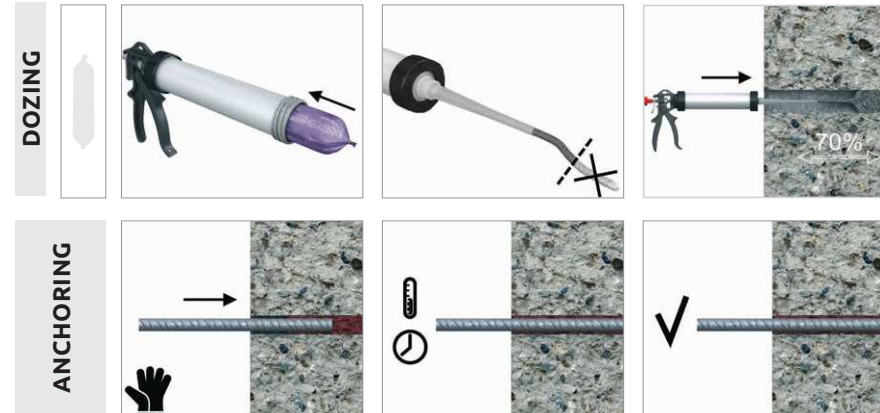

1. Drill hole to the required diameter and depth for rebar size being used.
2. Clean the drill hole thoroughly with brush and hand pump at least four times before installation
3. Insert cartridge into gun and attach nozzle.
4. Dispense to waste until even colour is obtained (min. 10 cm)
5. Insert the mixer nozzle to the bottom of the drill hole and inject resin, slowly withdrawing the nozzle as the hole is filled to 70% of its depth.
6. Immediately insert the rebar, slowly and with slight twisting motion. Remove any excess resin around the hole before it sets and leave it undisturbed until the curing time elapses.

PRODUCT INFORMATION

Product Code	Resin	Description / Resin Type	Volume
			[m]
R-KER-II-300	R-KER-II	R-KER II Hybrid Resin	300
R-KER-II-345			345
R-KER-II-400			400
R-KER-II-300-S	R-KER-II-S	R-KER II Hybrid Resin for High Temperature (Summer) / Slow Cure Styrene Free Hybrid Resin	300
R-KER-II-400-S			400
R-KER-II-300-W	R-KER-II-W	R-KER II Hybrid Resin for Low Temperature (Winter) / Rapid Cure Styrene Free Hybrid Resin	300
R-KER-II-345-W			345
R-KER-II-400-W			400
R-KER-II-400-SV	R-KER-II	R-KER II Hybrid Resin	300
R-CFS+KERII-600	R-CFS+KERII	R-KER II Hybrid Resin	600
R-CFS+KERII-600-S	R-CFS+KERII	R-KER II Hybrid Resin for High Temperature (Summer) / Slow Cure Styrene Free Hybrid Resin	600
R-CFS+KERII-600-W	R-CFS+KERII	R-KER II Hybrid Resin for High Temperature (Winter) / Fast Cure Styrene Free Hybrid Resin	600

INSTALLATION DATA

REBARS AS ANCHORS

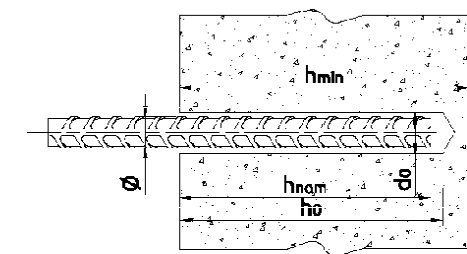

Size	Ø8	Ø10	Ø12	Ø14	Ø16	Ø20	Ø25	Ø32		
Rebar diameter	d_s	[mm]	8	10	12	14	16	20	25	32
Hole diameter in substrate	d_o	[mm]	12	14	18	18	22	26	32	40
Min. hole depth in substrate	h_o	[mm]	$h_{nom}+5$	$h_{nom}+5$	$h_{nom}+5$	$h_{nom}+5$	$h_{nom}+5$	$h_{nom}+5$	$h_{nom}+5$	$h_{nom}+5$
Min. substrate thickness	h_{min}	[mm]	$h_{nom}+30$ ≥ 100	$h_{nom}+30$ ≥ 100	$h_{nom}+30$ ≥ 100	$h_{nom}+30$ ≥ 100	$h_{nom}+2d_o$	$h_{nom}+2d_o$	$h_{nom}+2d_o$	$h_{nom}+2d_o$
Min. spacing	s_{min}	[mm]	40	40	40	40	40	50	70	
Min. edge distance	c_{min}	[mm]	40	40	40	40	40	50	70	
MINIMUM EMBEDMENT DEPTH										
Min. installation depth	$h_{nom, min}$	[mm]	60	60	60	60	64	80	100	128
MAXIMUM EMBEDMENT DEPTH										
Min. installation depth	$h_{nom, max}$	[mm]	160	200	240	280	320	400	500	640

R-KER-II | R-CFS+KER-II WITH REBAR AS AN ANCHOR

INSTALLATION DATA (cont.)

Minimum working and curing time

R-KER-II

Resin temperature °C	Concrete temperature °C	Curing time* [min.]			Working time [min]		
		R-KER-II S	R-KER-II	R-KER-II W	R-KER-II S	R-KER-II	R-KER-II W
5	-20	-	-	1440	-	-	100
5	-15	-	-	960	-	-	60
5	-10	-	-	480	-	-	40
5	-5	-	1440	240	-	40	20
5	0	-	3h	2h	-	30	14
5	5	12h	1.5h	60	40	15	9
10	10	8h	60	45	20	8	5.5
15	15	6h	60	30	15	5	3
20	20	4h	45	15	10	2.5	2
25	25	3h	45	10	9.5	2	1.5
25	30	2h	45	10	7	2	1.5
25	35	2h	30	5	6.5	1.5	1
25	40	1.5h	30	5	6.5	1.5	1

*For wet concrete the curing time must be doubled

MECHANICAL PROPERTIES

REBARS AS ANCHORS

Size	Ø8	Ø10	Ø12	Ø14	Ø16	Ø20	Ø25	Ø32		
f_{uk} = 540 (e.g. 500 B acc. to BS 4449; B 500 B acc. to SS 560)										
Nominal ultimate tensile strength - tension	f_{uk}	[N/mm ²]	540	540	540	540	540	540	540	
Nominal yield strength - tension	f_{yk}	[N/mm ²]	500	500	500	500	500	500	500	
Cross sectional area - tension	A_s	[mm ²]	50.3	78.5	113.1	153.9	201.1	314.2	490.9	804.2
Elastic section modulus	W_{el}	[mm ³]	50.3	98.2	169.6	269.4	402.1	785.4	1534	3217
f_{uk} = 575 (e.g. B 500 SP acc. to EC2)										
Nominal ultimate tensile strength - tension	f_{uk}	[N/mm ²]	575	575	575	575	575	575	575	
Nominal yield strength - tension	f_{yk}	[N/mm ²]	500	500	500	500	500	500	500	
Cross sectional area - tension	A_s	[mm ²]	50.3	78.5	113.1	153.9	201.1	314.2	490.9	804.2
Elastic section modulus	W_{el}	[mm ³]	50.3	98.2	169.6	269.4	402.1	785.4	1534	3217
f_{uk} = 620 (e.g. G-60 acc. to ASTM 615)										
Nominal ultimate tensile strength - tension	f_{uk}	[N/mm ²]	620	620	620	620	620	620	620	
Nominal yield strength - tension	f_{yk}	[N/mm ²]	420	420	420	420	420	420	420	
Cross sectional area - tension	A_s	[mm ²]	50.3	78.5	113.1	153.9	201.1	314.2	490.9	804.2
Elastic section modulus	W_{el}	[mm ³]	50.3	98.2	169.6	269.4	402.1	785.4	1534	3217

BASIC PERFORMANCE DATA

REBARS AS ANCHORS

Performance data for single anchor without influence of edge distance and spacing

Size	Ø8	Ø10	Ø12	Ø14	Ø16	Ø20	Ø25	Ø32	Ø8	Ø10	Ø12	Ø14	Ø16	Ø20	Ø25	Ø32	
Substrate	Non-cracked concrete								Cracked concrete								
MEAN ULTIMATE LOAD																	
TENSION LOAD $N_{Rk,m}$																	
f_{uk} = 540 (e.g. 500 B acc. to BS 4449; B 500 B acc. to SS 560)																	
Minimum embedment depth	[kN]	26.77	31.37	31.37	31.37	34.56	48.30	67.50	97.75	22.08	22.08	22.08	22.08	24.32	33.99	47.50	68.79
Maximum embedment depth	[kN]	28.50	44.53	64.13	87.28	114.00	178.1	278.33	456.01	28.50	44.53	64.13	87.28	114.00	178.13	278.33	456.01
f_{uk} = 575 (e.g. B 500 SP acc. to EC2)																	
Minimum embedment depth	[kN]	26.77	31.37	31.37	31.37	34.56	48.30	67.50	97.75	22.08	22.08	22.08	22.08	24.32	33.99	47.50	68.79
Maximum embedment depth	[kN]	30.55	47.42	68.28	92.94	121.39	189.67	296.37	485.56	30.35	47.42	68.28	92.94	121.39	189.67	296.37	485.56
f_{uk} = 620 (e.g. G-60 acc. to ASTM 615)																	
Minimum embedment depth	[kN]	26.77	31.37	31.37	31.37	34.56	48.30	67.50	97.75	22.08	22.08	22.08	22.08	24.32	33.99	47.50	68.79
Maximum embedment depth	[kN]	32.72	51.13	73.63	100.21	130.89	204.52	319.56	523.57	32.72	51.13	73.63	100.21	130.89	204.52	319.56	523.57
SHEAR LOAD $V_{Rk,m}$																	
f_{uk} = 540 (e.g. 500 B acc. to BS 4449; B 500 B acc. to SS 560)																	
Minimum embedment depth	[kN]	17.10	26.72	38.48	52.37	68.40	96.60	135.00	195.50	17.10	26.72	38.48	44.15	48.64	67.98	95.00	137.57
Maximum embedment depth	[kN]	17.10	26.72	38.48	52.37	68.40	106.88	167.00	273.61	17.10	26.72	38.48	52.37	68.40	106.88	167.00	273.61
f_{uk} = 575 (e.g. B 500 SP acc. to EC2)																	
Minimum embedment depth	[kN]	18.21	28.45	40.97	55.76	69.12	96.60	135.00	195.50	18.21	28.45	40.97	44.15	48.64	67.98	95.00	137.57
Maximum embedment depth	[kN]	18.21	28.45	40.97	55.76	72.83	113.80	177.82	291.34	18.24	28.45	40.97	55.76	72.83	113.80	177.82	291.34
f_{uk} = 620 (e.g. G-60 acc. to ASTM 615)																	
Minimum embedment depth	[kN]	19.63	30.68	44.18	60.13	69.12	96.60	135.00	195.50	19.63	30.68	44.15	44.15	48.64	67.98	95.00	137.57
Maximum embedment depth	[kN]	19.63	30.68	44.18	60.13	78.53	122.71	191.74	314.14	19.63	30.68	44.18	60.13	78.53	122.71	191.74	314.14

R-KER-II | R-CFS+KER-II WITH REBAR AS AN ANCHOR

BASIC PERFORMANCE DATA (cont.)

Size		Ø8	Ø10	Ø12	Ø14	Ø16	Ø20	Ø25	Ø32	Ø8	Ø10	Ø12	Ø14	Ø16	Ø20	Ø25	Ø32
CHARACTERISTIC LOAD																	
TENSION LOAD N_{Rk}																	
$f_{uk} = 540$ (e.g. 500 B acc. to BS 4449; B 500 B acc. to SS 560)																	
Minimum embedment depth	[kN]	19.60	22.86	22.86	22.86	25.19	35.20	49.19	71.24	12.06	16.00	16.00	16.00	17.63	24.64	34.44	45.04
Maximum embedment depth	[kN]	27.14	42.41	61.07	83.13	108.57	169.7	265.1	434.3	27.1	42.4	61.1	83.1	108.6	169.7	235.6	225.2
$f_{uk} = 575$ (e.g. B 500 SP acc. to EC2)																	
Minimum embedment depth	[kN]	19.60	22.86	22.86	22.86	25.19	35.20	49.19	71.24	12.06	16.00	16.00	16.00	17.63	24.64	34.44	45.04
Maximum embedment depth	[kN]	28.90	45.16	65.03	88.51	115.61	180.64	282.25	462.44	28.90	45.16	65.03	88.51	115.61	180.64	235.62	225.19
$f_{uk} = 620$ (e.g. G-60 acc. to ASTM 615)																	
Minimum embedment depth	[kN]	19.60	22.86	22.86	22.86	25.19	35.20	49.19	71.24	12.06	16.00	16.00	16.00	17.63	24.64	34.44	45.04
Maximum embedment depth	[kN]	31.16	48.69	70.12	95.44	124.66	194.78	304.34	482.55	31.16	48.69	70.12	95.44	124.66	188.50	235.62	225.19
SHEAR LOAD V_{Rk}																	
$f_{uk} = 540$ (e.g. 500 B acc. to BS 4449; B 500 B acc. to SS 560)																	
Minimum embedment depth	[kN]	13.57	21.21	30.54	41.56	50.37	70.40	98.39	142.48	13.57	21.21	30.54	32.01	35.26	49.28	68.87	90.08
Maximum embedment depth	[kN]	13.57	21.21	30.54	41.56	54.29	84.82	132.54	217.15	13.57	21.21	30.54	41.56	54.29	84.82	132.54	217.15
$f_{uk} = 575$ (e.g. B 500 SP acc. to EC2)																	
Minimum embedment depth	[kN]	14.45	22.58	32.52	44.26	50.37	70.40	98.39	142.48	14.45	22.58	32.01	32.01	35.26	49.28	68.87	90.08
Maximum embedment depth	[kN]	14.45	22.58	32.52	44.26	57.81	90.32	141.13	231.22	14.45	22.58	32.52	44.26	57.81	90.32	141.13	231.22
$f_{uk} = 620$ (e.g. G-60 acc. to ASTM 615)																	
Minimum embedment depth	[kN]	15.58	24.35	35.06	45.73	50.37	70.40	98.39	142.48	15.58	24.35	32.01	32.01	35.26	49.28	68.87	90.08
Maximum embedment depth	[kN]	15.58	24.35	35.06	47.72	62.33	97.39	152.17	249.32	15.58	24.35	35.06	47.72	62.33	97.39	152.17	249.32
DESIGN LOAD																	
TENSION LOAD N_{Rd}																	
$f_{uk} = 540$ (e.g. 500 B acc. to BS 4449; B 500 B acc. to SS 560)																	
Minimum embedment depth	[kN]	13.07	15.24	15.24	15.24	16.79	23.47	32.80	47.49	8.04	10.67	10.67	10.67	11.75	11.75	22.96	30.30
Maximum embedment depth	[kN]	19.39	30.29	43.62	59.38	77.55	121.18	189.34	310.21	19.39	30.29	43.62	59.38	77.55	121.18	157.08	150.13
$f_{uk} = 575$ (e.g. B 500 SP acc. to EC2)																	
Minimum embedment depth	[kN]	13.07	15.24	15.24	15.24	16.79	23.47	32.80	47.49	8.04	10.67	10.67	10.67	11.75	11.75	22.96	30.30
Maximum embedment depth	[kN]	20.64	32.36	46.45	63.22	82.58	129.03	201.61	321.70	20.64	32.36	46.45	63.22	82.58	125.66	157.08	150.13
$f_{uk} = 620$ (e.g. G-60 acc. to ASTM 615)																	
Minimum embedment depth	[kN]	13.07	15.24	15.24	15.24	16.79	23.47	32.80	47.49	8.04	10.67	10.67	10.67	11.75	11.75	22.96	30.30
Maximum embedment depth	[kN]	22.26	34.78	50.09	68.17	89.04	139.13	217.39	321.70	21.45	34.78	50.09	68.17	89.04	125.66	157.08	150.13
SHEAR LOAD V_{Rd}																	
$f_{uk} = 540$ (e.g. 500 B acc. to BS 4449; B 500 B acc. to SS 560)																	
Minimum embedment depth	[kN]	9.05	14.14	20.36	27.71	33.58	46.93	65.59	94.99	9.05	14.14	20.36	21.34	24.6	34.4	48.0	60.1
Maximum embedment depth	[kN]	9.05	14.14	20.36	27.71	36.19	56.55	88.436	144.76	9.05	14.14	20.36	27.71	36.19	56.55	88.36	144.76
$f_{uk} = 575$ (e.g. B 500 SP acc. to EC2)																	
Minimum embedment depth	[kN]	9.63	15.05	21.68	29.50	33.58	46.93	65.59	94.99	9.63	15.05	21.34	21.34	24.6	34.4	48.0	60.1
Maximum embedment depth	[kN]	9.63	15.05	21.68	29.50	38.54	60.21	94.08	154.15	9.63	15.05	21.68	29.50	38.54	60.21	94.08	154.15
$f_{uk} = 620$ (e.g. G-60 acc. to ASTM 615)																	
Minimum embedment depth	[kN]	10.39	16.23	23.37	30.48	33.58	46.93	65.59	94.99	10.39	16.23	21.34	21.34	23.51	32.85	45.91	60.05
Maximum embedment depth	[kN]	10.39	16.23	23.37	31.81	41.55	64.93	101.45	166.21	10.39	16.23	23.37	31.81	41.55	64.93	101.45	166.21
RECOMMENDED LOAD																	
TENSION LOAD N_{rec}																	
$f_{uk} = 540$ (e.g. 500 B acc. to BS 4449; B 500 B acc. to SS 560)																	
Minimum embedment depth	[kN]	9.34	10.89	10.89	10.89	11.99	16.76	23.43	33.92	5.74	7.62	7.62	7.62	8.40	11.73	16.40	21.45
Maximum embedment depth	[kN]	13.85	21.64	31.16	42.41	55.39	86.55	135.24	221.58	13.85	21.64	31.16	42.41	55.39	86.55	112.20	107.23
$f_{uk} = 575$ (e.g. B 500 SP acc. to EC2)																	
Minimum embedment depth	[kN]	9.34	10.89	10.89	10.89	11.99	16.76	23.43	33.92	5.74	7.62	7.62	7.62	8.40	11.73	16.40	21.45
Maximum embedment depth	[kN]	14.75	23.04	33.18	45.16	58.99	92.16	144.01	229.79	14.75	23.04	33.18	45.16	58.99	89.76	112.20	107.23
$f_{uk} = 620$ (e.g. G-60 acc. to ASTM 615)																	
Minimum embedment depth	[kN]	9.34	10.89	10.89	10.89	11.99	16.76	23.43	33.92	5.74	7.62	7.62	7.62	8.40	11.73	16.40	21.45
Maximum embedment depth	[kN]	15.90	24.84	35.78	48.69	63.60	99.38	155.28	229.79	15.32	24.84	35.78	48.69	63.60	89.76	112.20	107.23
SHEAR LOAD V_{rec}																	
$f_{uk} = 540$ (e.g. 500 B acc. to BS 4449; B 500 B acc. to SS 560)																	
Minimum embedment depth	[kN]	6.46	10.10	14.54	19.79	23.99	33.52	46.85	67.85	6.46	10.10	14.54	15.24	16.79	23.47	32.80	42.89
Maximum embedment depth	[kN]	6.46	10.10	14.54	19.79	25.85	40.39	63.11	103.40	6.46	10.10	14.54	19.79	25.85	40.39	63.11	103.40
$f_{uk} = 575$ (e.g. B 500 SP acc. to EC2)																	
Minimum embedment depth	[kN]	6.46	10.75	15.48	21.07	23.99	33.52	46.85	67.85	6.88	10.75	15.24	15.24	16.79	23.47	32.80	42.89
Maximum embedment depth	[kN]	6.88	10.75	15.48	21.07	27.53	43.01	67.20	110.11	6.88	10.75	15.48	21.07	27.53	43.01	67.20	110.11
$f_{uk} = 620$ (e.g. G-60 acc. to ASTM 615)																	
Minimum embedment depth	[kN]	7.42	11.59	16.70	21.77	23.99	33.52	46.85	67.85	6.46	10.10	14.54	15.24	16.79	23.47	32.80	42.89
Maximum embedment depth	[kN]	7.42	11.59	16.70	22.72	29.68	46.38	72.46	118.72	7.42	11.59	16.70	22.72	29.68	46.38	72.46	118.72

R-KER-II | R-CFS+KER-II WITH REBAR AS AN ANCHOR

DESIGN PERFORMANCE DATA

REBARS AS ANCHORS

Size		Ø8	Ø10	Ø12	Ø14	Ø16	Ø20	Ø25	Ø32
TENSION LOAD									
STEEL FAILURE; $F_{UK} = 540$ (E.G. 500 B ACC. TO BS 4449; B 500 B ACC. TO SS 560)									
Characteristic resistance	$N_{Rk,s}$ [kN]	27.14	42.41	61.07	83.13	108.57	169.65	265.07	434.29
Partial safety factor	γ_{Ms}	1.40	1.40	1.40	1.40	1.40	1.40	1.40	1.40
STEEL FAILURE; $F_{UK} = 575$ (E.G. B 500 SP ACC. TO EC2)									
Characteristic resistance	$N_{Rk,s}$ [kN]	28.90	45.16	65.03	88.51	115.61	180.64	282.25	462.44
Partial safety factor	γ_{Ms}	1.40	1.40	1.40	1.40	1.40	1.40	1.40	1.40
STEEL FAILURE; $F_{UK} = 620$ (E.G. G-60 ACC. TO ASTM 615)									
Characteristic resistance	$N_{Rk,s}$ [kN]	31.16	48.69	70.12	95.44	124.66	194.78	304.34	498.63
Partial safety factor	γ_{Ms}	1.40	1.40	1.40	1.40	1.40	1.40	1.40	1.40
WORKING LIFE 50 YEARS									
COMBINED PULL-OUT AND CONCRETE CONE FAILURE; NON-CRACKED CONCRETE, C20/25 (40°C/24°C)									
Characteristic bond resistance	T_{Rk} [N/mm ²]	13.00	14.00	14.00	13.00	13.00	10.00	9.00	7.50
Sustained load factor	ψ_{sus}^0	0.72	0.72	0.72	0.72	0.72	0.72	0.72	0.72
COMBINED PULL-OUT AND CONCRETE CONE FAILURE; NON-CRACKED CONCRETE, C20/25 (80°C/50°C)									
Characteristic bond resistance	T_{Rk} [N/mm ²]	13.00	14.00	14.00	13.00	13.00	10.00	9.00	7.50
Sustained load factor	ψ_{sus}^0	0.61	0.61	0.61	0.61	0.61	0.61	0.72	0.72
COMBINED PULL-OUT AND CONCRETE CONE FAILURE; NON-CRACKED CONCRETE, C20/25 (120°C/80°C)									
Characteristic bond resistance	T_{Rk} [N/mm ²]	7.00	7.00	7.00	7.00	7.00	5.50	5.00	4.00
Sustained load factor	ψ_{sus}^0	0.61	0.61	0.61	0.61	0.61	0.61	0.61	0.61
COMBINED PULL-OUT AND CONCRETE CONE FAILURE; CRACKED CONCRETE, C20/25 (40°C/24°C)									
Characteristic bond resistance	T_{Rk} [N/mm ²]	8.00	9.00	10.00	10.00	8.50	7.50	6.00	3.50
Sustained load factor	ψ_{sus}^0	0.72	0.72	0.72	0.72	0.72	0.72	0.72	0.72
COMBINED PULL-OUT AND CONCRETE CONE FAILURE; CRACKED CONCRETE, C20/25 (80°C/50°C)									
Characteristic bond resistance	T_{Rk} [N/mm ²]	8.00	9.00	10.00	10.00	8.50	7.50	6.00	3.50
Sustained load factor	ψ_{sus}^0	0.72	0.72	0.72	0.72	0.72	0.72	0.72	0.72
COMBINED PULL-OUT AND CONCRETE CONE FAILURE; CRACKED CONCRETE, C20/25 (120°C/80°C)									
Characteristic bond resistance	T_{Rk} [N/mm ²]	4.50	5.00	5.00	5.00	4.50	4.00	3.00	2.00
Sustained load factor	ψ_{sus}^0	0.61	0.61	0.61	0.61	0.61	0.61	0.61	0.61
WORKING LIFE 100 YEARS									
COMBINED PULL-OUT AND CONCRETE CONE FAILURE; NON-CRACKED CONCRETE, C20/25 (40°C/24°C)									
Characteristic bond resistance	T_{Rk} [N/mm ²]	12.00	14.00	14.00	12.00	12.00	10.00	8.50	7.50
Sustained load factor	ψ_{sus}^0	0.6	0.6	0.6	0.6	0.6	0.6	0.6	0.6
COMBINED PULL-OUT AND CONCRETE CONE FAILURE; NON-CRACKED CONCRETE, C20/25 (80°C/50°C)									
Characteristic bond resistance	T_{Rk} [N/mm ²]	12.00	1						

R-KER-II | R-CFS+KER-II WITH REBAR AS AN ANCHOR

DESIGN PERFORMANCE DATA (cont.)

Size			Ø8	Ø10	Ø12	Ø14	Ø16	Ø20	Ø25	Ø32
SHEAR LOAD										
STEEL FAILURE; F_{UK} = 540 (E.G. 500 B ACC. TO BS 4449; B 500 B ACC. TO SS 560)										
Characteristic resistance without lever arm	V _{Rk,s}	[kN]	13.57	21.21	30.54	41.56	54.29	84.82	132.54	217.15
Ductility factor	k _γ	-	0.80	0.80	0.80	0.80	0.80	0.80	0.80	0.80
Characteristic resistance with lever arm	M _{Rk,s}	[Nm]	32.57	63.62	109.93	174.57	260.58	508.94	994.02	2084.61
Partial safety factor	V _{MtS}	-	1.50	1.50	1.50	1.50	1.50	1.50	1.50	1.50
STEEL FAILURE; F_{UK} = 575 (E.G. B 500 SP ACC. TO EC2)										
Characteristic resistance without lever arm	V _{Rk,s}	[kN]	14.45	22.59	32.52	44.26	57.81	90.32	141.13	231.22
Ductility factor	k _γ	-	0.80	0.80	0.80	0.80	0.80	0.80	0.80	0.80
Characteristic resistance with lever arm	M _{Rk,s}	[Nm]	34.68	67.74	117.06	185.88	277.47	541.92	1058.45	2219.72
Partial safety factor	V _{MtS}	-	1.50	1.50	1.50	1.50	1.50	1.50	1.50	1.50
STEEL FAILURE; F_{UK} = 620 (E.G. G-60 ACC. TO ASTM 615)										
Characteristic resistance without lever arm	V _{Rk,s}	[kN]	15.58	24.35	35.06	47.72	62.33	97.39	152.17	249.32
Ductility factor	k _γ	-	0.80	0.80	0.80	0.80	0.80	0.80	0.80	0.80
Characteristic resistance with lever arm	M _{Rk,s}	[Nm]	37.40	73.04	126.22	200.43	299.18	584.34	1141.28	2393.44
Partial safety factor	V _{MtS}	-	1.50	1.50	1.50	1.50	1.50	1.50	1.50	1.50
CONCRETE PRY-OUT FAILURE										
Factor	k	-	2.00	2.00	2.00	2.00	2.00	2.00	2.00	2.00
Installation safety factor	V ₂	-	1.00	1.00	1.00	1.00	1.00	1.00	1.00	1.00
CONCRETE EDGE FAILURE										
Anchor diameter	d _{nom}	[mm]	8.00	10.00	12.00	14.00	16.00	20.00	25.00	32.00
Effective length of anchor	ℓ _f	[mm]	min(300; h _{ef} ; 12d _{nom})	min(300; h _{ef} ; 12d _{nom})	min(300; h _{ef} ; 12d _{nom})	min(300; h _{ef} ; 12d _{nom})	min(300; h _{ef} ; 12d _{nom})	min(300; h _{ef} ; 12d _{nom})	min(300; h _{ef} ; 12d _{nom})	min(300; h _{ef} ; 12d _{nom})
Installation safety factor	V ₂	-	1.00	1.00	1.00	1.00	1.00	1.00	1.00	1.00

Combined pull-out and concrete cone failure:

(acc. TR 029, p.5.2.2.3. acc. to formula (5.2a) - $N_{Rk,D}^0 = n \cdot d \cdot h_{ef} \cdot \tau_{Rk}$
 acc. EN 1992-4, p.7.2.1.6. acc. to formula (7.14) - $N_{Rk,D}^0 = \psi_{sus} \cdot n \cdot d \cdot h_{ef} \cdot \tau_{Rk}$ where $\psi_{sus} = \psi^0_{sus} + 1 - \alpha_{sus} \leq 1$ (7.14a,b)).

Concrete cone failure:

(acc. TR 029, p.5.2.2.4. acc. to formula (5.3a) - $N_{Rk,C}^0 = k_1 \cdot f_{ck,cube}^{0.5} \cdot h_{ef}^{1.5}$
 Acc. EN 1992-4, p.7.2.1.4. acc. to formula (7.2) - $N_{Rk,C}^0 = k_{UC,N} \cdot f_{ck}^{0.5} \cdot h_{ef}^{1.5}$).

Allowable values for resistance in case of Seismic performance category C1

Size			Ø8	Ø10	Ø12	Ø14	Ø16	Ø20	Ø25	Ø32
TENSION LOAD										
STEEL FAILURE; F_{UK} = 540 (E.G. 500 B ACC. TO BS 4449; B 500 B ACC. TO SS 560)										
Characteristic resistance	N _{Rk,s}	[kN]	27.14	42.41	61.07	83.13	108.57	169.65	265.07	434.29
Partial safety factor	V _{Mt,SeisC1}	-	1.40	1.40	1.40	1.40	1.40	1.40	1.40	1.40
STEEL FAILURE; F_{UK} = 575 (E.G. B 500 SP ACC. TO EC2)										
Characteristic resistance	N _{Rk,s}	[kN]	28.90	45.16	65.03	88.51	115.61	180.64	282.25	462.44
Partial safety factor	V _{Mt,SeisC1}	-	1.40	1.40	1.40	1.40	1.40	1.40	1.40	1.40
STEEL FAILURE; F_{UK} = 620 (E.G. G-60 ACC. TO ASTM 615)										
Characteristic resistance	N _{Rk,s}	[kN]	31.16	48.69	70.12	95.44	124.66	194.78	304.34	498.63
Partial safety factor	V _{Mt,SeisC1}	-	1.40	1.40	1.40	1.40	1.40	1.40	1.40	1.40
COMBINED PULL-OUT AND CONCRETE CONE FAILURE; CRACKED CONCRETE, C20/25 (40°C/24°C)										
Characteristic bond resistance	T _{Rk}	[N/mm ²]	7.00	8.50	10.00	10.00	8.50	7.50	6.00	3.50
COMBINED PULL-OUT AND CONCRETE CONE FAILURE; CRACKED CONCRETE, C20/25 (80°C/50°C)										
Characteristic bond resistance	T _{Rk}	[N/mm ²]	7.00	8.50	10.00	10.00	8.50	7.50	6.00	3.50
COMBINED PULL-OUT AND CONCRETE CONE FAILURE; CRACKED CONCRETE, C20/25 (120°C/80°C)										
Characteristic bond resistance	T _{Rk}	[N/mm ²]	4.00	4.50	5.00	5.00	4.50	4.00	3.00	1.50
PULL-OUT FAILURE										
Installation safety factor	V _{inst}	-	1.00	1.00	1.00	1.00	1.00	1.00	1.00	1.00
SHEAR LOAD										
STEEL FAILURE; F_{UK} = 540 (E.G. 500 B ACC. TO BS 4449; B 500 B ACC. TO SS 560)										
Characteristic resistance	N _{Rk,s}	[kN]	9.50	14.84	21.38	29.09	38.00	59.38	92.78	152.00
Partial safety factor	V _{Mt,SeisC1}	-	1.50	1.50	1.50	1.50	1.50	1.50	1.50	1.50
STEEL FAILURE; F_{UK} = 575 (E.G. B 500 SP ACC. TO EC2)										
Characteristic resistance	N _{Rk,s}	[kN]	10.12	15.81	22.76	30.98	40.46	63.22	98.79	161.85
Partial safety factor	V _{Mt,SeisC1}	-	1.50	1.50	1.50	1.50	1.50	1.50	1.50	1.50
STEEL FAILURE; F_{UK} = 620 (E.G. G-60 ACC. TO ASTM 615)										
Characteristic resistance	N _{Rk,s}	[kN]	10.91	17.04	24.51	33.40	43.63	68.17	106.52	174.52
Partial safety factor	V _{Mt,SeisC1}	-	1.50	1.50	1.50	1.50	1.50	1.50	1.50	1.50

R-HAC-V HAMMER-IN WITH REBAR

Heavy duty anchor with small spacing and edge distances, simply installed by hammering the rebar

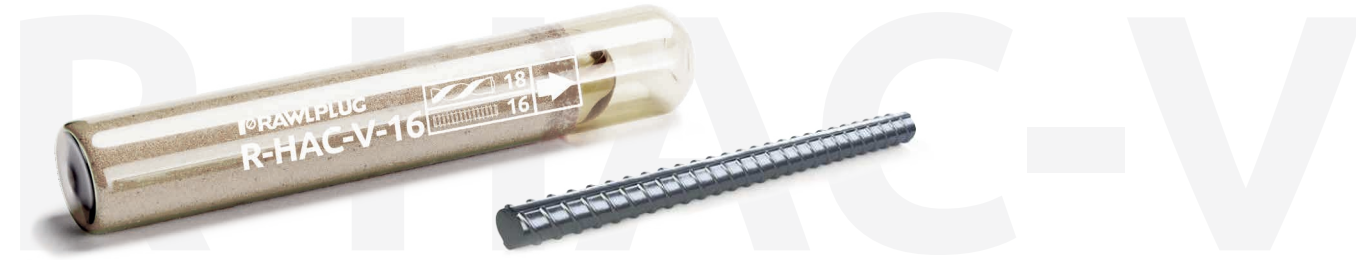

FEATURES AND BENEFITS

- Approved for use with rebar in non-cracked concrete (ETAG001 Option 7)
- High performance anchor, for use in safety critical applications
- The system relies on the adhesion between concrete and resin, which is free from expansion forces. This makes it an ideal choice where close edge and spacing distances are required
- Capsule contains precise amounts of ingredients making it a very consistent product
- Adhesive bond strength is not affected by unpolluted water
- Suitable for dry or wet non-cracked concrete
- Ideal for starter bar applications
- Low cost tooling required for installation, quick and easy to install
- Styrene free - virtually odourless

APPLICATIONS

- Reinforcement bars
- Cable trays
- Heavy machinery
- Fencing & gates manufacturing and installation
- Formwork support systems

BASE MATERIALS

- Approved for use in:
 - Non-cracked concrete C20/25-C50/60
- Also suitable for use in:
 - Natural Stone (after site testing)

INSTALLATION GUIDE

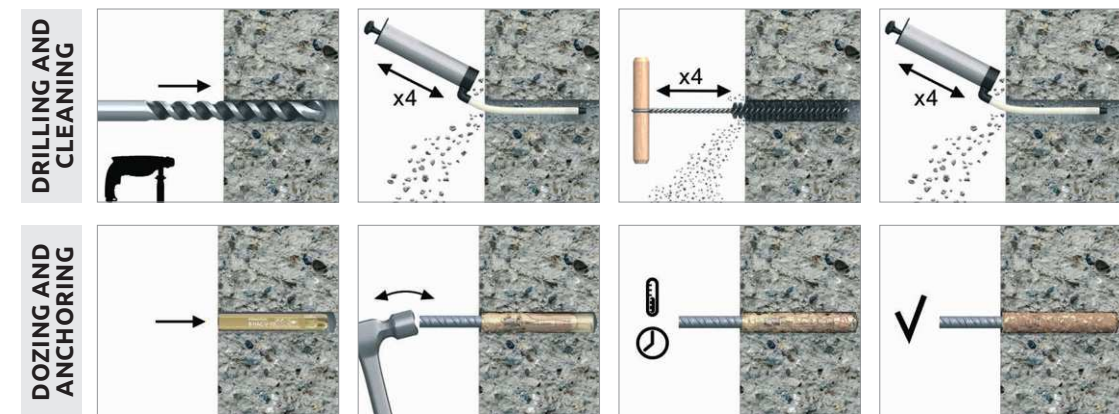

- Drill hole to the required diameter and depth for stud size being used.
- Clean the hole thoroughly with brush and hand pump at least four times before installation.
- Insert capsule into the hole.
- The stud is simply hammered through the capsule using a manual or mechanical hammer (M16-M30).
- Leave the anchor undisturbed until the curing time elapses.

PRODUCT INFORMATION

Size	Product Code	Description / Resin Type
M8	R-HAC-V-08	Styrene Free Vinyl ester Resin
M10	R-HAC-V-10	
M12	R-HAC-V-12	
M16	R-HAC-V-16	
M20	R-HAC-V-20	
M24	R-HAC-V-24	
M30	R-HAC-V-30	

R-HAC-V HAMMER-IN WITH REBAR

INSTALLATION DATA

REBARS AS ANCHORS

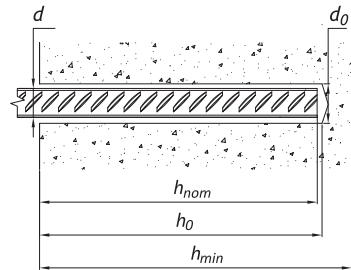

Size		Ø8	Ø10	Ø12	Ø14	Ø16	Ø20	Ø25
Rebar diameter	d_s [mm]	8	10	12	14	16	20	25
Hole diameter in substrate	d_0 [mm]	12	14	18	18	22	26	35
Capsule size	- [mm]	10	12	16	16	20	24	30
Capsule diameter	d_c [mm]	10.75	12.65	16.75	16.75	21.55	23.75	33.2
Min. hole depth in substrate	h_0 [mm]	$h_{nom} + 5$	$h_{nom} + 5$	$h_{nom} + 5$	$h_{nom} + 5$	$h_{nom} + 5$	$h_{nom} + 5$	$h_{nom} + 5$
Min. installation depth	h_{nom} [mm]	80	90	110	110	125	170	210
Min. substrate thickness	h_{min} [mm]	120	130	140	140	180	230	270
Min. spacing	s_{min} [mm]	$0.5 * h_{nom} \geq 40$	$0.5 * h_{nom} \geq 40$	$0.5 * h_{nom} \geq 40$	$0.5 * h_{nom} \geq 40$	$0.5 * h_{nom} \geq 40$	$0.5 * h_{nom} \geq 40$	$0.5 * h_{nom} \geq 40$
Min. edge distance	c_{min} [mm]	$0.5 * h_{nom} \geq 40$	$0.5 * h_{nom} \geq 40$	$0.5 * h_{nom} \geq 40$	$0.5 * h_{nom} \geq 40$	$0.5 * h_{nom} \geq 40$	$0.5 * h_{nom} \geq 40$	$0.5 * h_{nom} \geq 40$

REBARS AS ANCHORS

Resin temperature	Concrete temperature	Curing time*	Working time
[°C]	[°C]	[min]	[min]
5	-5	1440	-
5	0	840	-
5	5	240	-
10	10	180	-
15	15	90	-
20	20	45	-
25	30	20	-
25	40	10	-

*For wet concrete the curing time must be doubled

MECHANICAL PROPERTIES

REBARS AS ANCHORS

Size		Ø8	Ø10	Ø12	Ø14	Ø16	Ø20	Ø25
f_{uk} = 540 (e.g. 500 B acc. to BS 4449; B 500 B acc. to SS 560)								
Nominal ultimate tensile strength - tension	F_{uk} [N/mm ²]	540	540	540	540	540	540	540
Nominal yield strength - tension	F_{yk} [N/mm ²]	500	500	500	500	500	500	500
Cross sectional area - tension	A_s [mm ²]	50.3	78.5	113.1	153.9	201.1	314.2	490.9
Elastic section modulus	W_{el} [mm ³]	50.3	98.2	169.6	269.4	402.1	785.4	1534
f_{uk} = 575 (e.g. B 500 SP acc. to EC2)								
Nominal ultimate tensile strength - tension	F_{uk} [N/mm ²]	575	575	575	575	575	575	575
Nominal yield strength - tension	F_{yk} [N/mm ²]	500	500	500	500	500	500	500
Cross sectional area - tension	A_s [mm ²]	50.3	78.5	113.1	153.9	201.1	314.2	490.9
Elastic section modulus	W_{el} [mm ³]	50.3	98.2	169.6	269.4	402.1	785.4	1534
f_{uk} = 620 (e.g. G-60 acc. to ASTM 615)								
Nominal ultimate tensile strength - tension	F_{uk} [N/mm ²]	620	620	620	620	620	620	620
Nominal yield strength - tension	F_{yk} [N/mm ²]	420	420	420	420	420	420	420
Cross sectional area - tension	A_s [mm ²]	50.3	78.5	113.1	153.9	201.1	314.2	490.9
Elastic section modulus	W_{el} [mm ³]	50.3	98.2	169.6	269.4	402.1	785.4	1534

R-HAC-V HAMMER-IN WITH REBAR

BASIC PERFORMANCE DATA

REBARS AS ANCHORS

Performance data for single anchor without influence of edge distance and spacing

Size		Ø8	Ø10	Ø12	Ø14	Ø16	Ø20	Ø25
Substrate		Non-cracked concrete						
MEAN ULTIMATE LOAD								
TENSION LOAD $N_{Rk,m}$								
$f_{uk} = 540$ (e.g. 500 B acc. to BS 4449; B 500 B acc. to SS 560)	[kN]	19.30	27.14	39.81	49.35	67.86	89.72	128.65
$f_{uk} = 575$ (e.g. B 500 SP acc. to EC2)	[kN]	19.30	27.14	39.81	49.35	67.86	89.72	128.65
$f_{uk} = 620$ (e.g. G-60 acc. to ASTM 615)	[kN]	19.30	27.14	39.81	49.35	67.86	89.72	128.65
SHEAR LOAD $V_{Rk,m}$								
$f_{uk} = 540$ (e.g. 500 B acc. to BS 4449; B 500 B acc. to SS 560)	[kN]	17.10	26.72	38.48	52.37	68.40	106.88	167.00
$f_{uk} = 575$ (e.g. B 500 SP acc. to EC2)	[kN]	18.21	28.45	40.97	55.76	72.83	113.80	177.82
$f_{uk} = 620$ (e.g. G-60 acc. to ASTM 615)	[kN]	19.63	30.68	44.18	60.13	78.53	122.71	191.74
CHARACTERISTIC LOAD								
TENSION LOAD N_{Rk}								
$f_{uk} = 540$ (e.g. 500 B acc. to BS 4449; B 500 B acc. to SS 560)	[kN]	16.08	22.62	33.18	41.12	56.55	74.77	107.21
$f_{uk} = 575$ (e.g. B 500 SP acc. to EC2)	[kN]	16.08	22.62	33.18	41.12	56.55	74.77	107.21
$f_{uk} = 620$ (e.g. G-60 acc. to ASTM 615)	[kN]	16.08	22.62	33.18	41.12	56.55	74.77	107.21
SHEAR LOAD V_{Rk}								
$f_{uk} = 540$ (e.g. 500 B acc. to BS 4449; B 500 B acc. to SS 560)	[kN]	13.57	21.21	30.54	41.56	54.29	84.82	132.54
$f_{uk} = 575$ (e.g. B 500 SP acc. to EC2)	[kN]	14.45	22.58	32.52	44.26	57.81	90.32	141.13
$f_{uk} = 620$ (e.g. G-60 acc. to ASTM 615)	[kN]	15.58	24.35	35.06	47.72	62.33	97.39	152.17
DESIGN LOAD								
TENSION LOAD N_{Rd}								
$f_{uk} = 540$ (e.g. 500 B acc. to BS 4449; B 500 B acc. to SS 560)	[kN]	8.94	12.57	18.43	22.85	31.42	41.54	59.56
$f_{uk} = 575$ (e.g. B 500 SP acc. to EC2)	[kN]	8.94	12.57	18.43	22.85	31.42	41.54	59.56
$f_{uk} = 620$ (e.g. G-60 acc. to ASTM 615)	[kN]	8.94	12.57	18.43	22.85	31.42	41.54	59.56
SHEAR LOAD V_{Rd}								
$f_{uk} = 540$ (e.g. 500 B acc. to BS 4449; B 500 B acc. to SS 560)	[kN]	9.05	14.14	20.36	27.71	36.19	56.55	88.36
$f_{uk} = 575$ (e.g. B 500 SP acc. to EC2)	[kN]	9.63	15.05	21.68	29.50	38.54	60.21	94.08
$f_{uk} = 620$ (e.g. G-60 acc. to ASTM 615)	[kN]	10.39	16.23	23.37	31.81	41.55	64.93	101.45
RECOMMENDED LOAD								
TENSION LOAD N_{rec}								
$f_{uk} = 540$ (e.g. 500 B acc. to BS 4449; B 500 B acc. to SS 560)	[kN]	6.38	8.98	13.16	16.32	22.44	29.67	42.54
$f_{uk} = 575$ (e.g. B 500 SP acc. to EC2)	[kN]	6.38	8.98	13.16	16.32	22.44	29.67	42.54
$f_{uk} = 620$ (e.g. G-60 acc. to ASTM 615)	[kN]	6.38	8.98	13.16	16.32	22.44	29.67	42.54
SHEAR LOAD V_{rec}								
$f_{uk} = 540$ (e.g. 500 B acc. to BS 4449; B 500 B acc. to SS 560)	[kN]	6.46	10.1	14.5	19.8	25.9	40.4	63.1
$f_{uk} = 575$ (e.g. B 500 SP acc. to EC2)	[kN]	6.88	10.8	15.5	21.1	27.4	43.0	67.2
$f_{uk} = 620$ (e.g. G-60 acc. to ASTM 615)	[kN]	7.42	11.6	16.7	22.7	29.7	46.4	72.5

R-HAC-V HAMMER-IN WITH REBAR

DESIGN PERFORMANCE DATA

REBARS AS ANCHORS

Size			Ø8	Ø10	Ø12	Ø14	Ø16	Ø20	Ø25
Effective embedment depth	h_{ef}	[mm]	80.00	90.00	110.00	110.00	125.00	170.00	210.00
TENSION LOAD									
STEEL FAILURE; F_{UK} = 540 (E.G. 500 B ACC. TO BS 4449; B 500 B ACC. TO SS 560)									
Characteristic resistance	$N_{Rk,S}$	[kN]	27.14	42.41	61.07	83.13	108.57	169.65	265.07
Partial safety factor	γ_{Ms}	-	1.40	1.40	1.40	1.40	1.40	1.40	1.40
STEEL FAILURE; F_{UK} = 575 (E.G. B 500 SP ACC. TO EC2)									
Characteristic resistance	$N_{Rk,S}$	[kN]	28.90	45.16	65.03	88.51	115.61	180.64	282.25
Partial safety factor	γ_{Ms}	-	1.40	1.40	1.40	1.40	1.40	1.40	1.40
STEEL FAILURE; F_{UK} = 620 (E.G. G-60 ACC. TO ASTM 615)									
Characteristic resistance	$N_{Rk,S}$	[kN]	31.16	48.69	70.12	95.44	124.66	194.78	304.34
Partial safety factor	γ_{Ms}	-	1.40	1.40	1.40	1.40	1.40	1.40	1.40
COMBINED PULL-OUT AND CONCRETE CONE FAILURE; NON-CRACKED CONCRETE, C20/25 (40°C/24°C)									
Characteristic bond resistance	T_{Rk}	[N/mm ²]	8.00	8.00	8.00	8.50	9.00	7.00	6.50
Sustained load factor	ψ_{sus}^0	-	0.60	0.60	0.60	0.60	0.60	0.60	0.60
COMBINED PULL-OUT AND CONCRETE CONE FAILURE; NON-CRACKED CONCRETE, C20/25 (80°C/50°C)									
Characteristic bond resistance	T_{Rk}	[N/mm ²]	7.00	7.00	7.00	7.00	7.50	6.00	5.50
Sustained load factor	ψ_{sus}^0	-	0.60	0.60	0.60	0.60	0.60	0.60	0.60
COMBINED PULL-OUT AND CONCRETE CONE FAILURE									
Installation safety factor	γ_2	-	1.20	1.20	1.20	1.20	1.20	1.20	1.20
Increasing factors for $N_{Rk,p}$ - C30/37	ψ_c	-	1.04	1.04	1.04	1.04	1.04	1.00	1.00
Increasing factors for $N_{Rk,p}$ - C40/50	ψ_c	-	1.07	1.07	1.07	1.07	1.07	1.00	1.07
Increasing factors for $N_{Rk,p}$ - C50/60	ψ_c	-	1.09	1.09	1.09	1.09	1.09	1.00	1.09
CONCRETE CONE FAILURE									
Installation safety factor	γ_2	-	1.20	1.20	1.20	1.20	1.20	1.20	1.20
Factor for non-cracked concrete	k_1	-	10.10	10.10	10.10	10.10	10.10	10.10	10.10
Factor for non-cracked concrete	$k_{scr,N}$	-	11.00	11.00	11.00	11.00	11.00	11.00	11.00
Edge distance	$c_{cr,N}$	[mm]	1.50	1.50	1.50	1.50	1.50	1.50	1.50
Spacing	$s_{cr,N}$	[mm]	3.00	3.00	3.00	3.00	3.00	3.00	3.00
CONCRETE SPLITTING FAILURE									
Installation safety factor	γ_2	-	1.20	1.20	1.20	1.20	1.20	1.20	1.20
Shear Load									
STEEL FAILURE; F_{UK} = 540 (E.G. 500 B ACC. TO BS 4449; B 500 B ACC. TO SS 560)									
Characteristic resistance without lever arm	$V_{Rk,S}$	[kN]	13.57	21.21	30.54	41.56	54.29	84.82	132.54
Ductility factor	k_7	-	0.80	0.80	0.80	0.80	0.80	0.80	0.80
Characteristic resistance with lever arm	$M_{Rk,S}$	[Nm]	32.57	63.62	109.93	174.57	260.58	508.94	994.02
Partial safety factor	γ_{Ms}	-	1.50	1.50	1.50	1.50	1.50	1.50	1.50
STEEL FAILURE; F_{UK} = 575 (E.G. B 500 SP ACC. TO EC2)									
Characteristic resistance without lever arm	$V_{Rk,S}$	[kN]	14.45	22.59	32.52	44.26	57.81	90.32	141.13
Ductility factor	k_7	-	0.80	0.80	0.80	0.80	0.80	0.80	0.80
Characteristic resistance with lever arm	$M_{Rk,S}$	[Nm]	34.68	67.74	117.06	185.88	277.47	541.92	1058.45
Partial safety factor	γ_{Ms}	-	1.50	1.50	1.50	1.50	1.50	1.50	1.50
STEEL FAILURE; F_{UK} = 620 (E.G. G-60 ACC. TO ASTM 615)									
Characteristic resistance without lever arm	$V_{Rk,S}$	[kN]	15.58	24.35	35.06	47.72	62.33	97.39	152.17
Ductility factor	k_7	-	0.80	0.80	0.80	0.80	0.80	0.80	0.80
Characteristic resistance with lever arm	$M_{Rk,S}$	[Nm]	37.40	73.04	126.22	200.43	299.18	584.34	1141.28
Partial safety factor	γ_{Ms}	-	1.50	1.50	1.50	1.50	1.50	1.50	1.50
CONCRETE PRY-OUT FAILURE									
Factor	k	-	2.00	2.00	2.00	2.00	2.00	2.00	2.00
Installation safety factor	γ_2	-	1.00	1.00	1.00	1.00	1.00	1.00	1.00
CONCRETE EDGE FAILURE									
Anchor diameter	d_{nom}	[mm]	8.00	10.00	12.00	14.00	16.00	20.00	25.00
Effective length of anchor	l_t	[mm]	80.00	90.00	110.00	110.00	125.00	170.00	210.00
Installation safety factor	γ_2	-	1.00	1.00	1.00	1.00	1.00	1.00	1.00

Combined pull-out and concrete cone failure:
 (acc. TR 029, p.5.2.2.3. acc. to formula (5.2a) - $N_{Rk,p}^0 = n \cdot d \cdot h_{ef} \cdot \tau_{Rk}$
 acc. EN 1992-4, p.7.2.1.6. acc. to formula (7.14) - $N_{Rk,p}^0 = \psi_{sus} \cdot n \cdot d \cdot h_{ef} \cdot \tau_{Rk}$ where $\psi_{sus} = \psi_{sus}^0 + 1 - \alpha_{sus} \leq 1$ (7.14a,b)).
 Concrete cone failure:
 (acc. TR 029, p.5.2.2.4. acc. to formula (5.3a) - $N_{Rk,c}^0 = k_1 \cdot f_{ck,cube}^{0.5} \cdot h_{ef}^{1.5}$
 Acc. EN 1992-4, p.7.2.1.4. acc. to formula (7.2) - $N_{Rk,c}^0 = k_{scr,N} \cdot f_{ck}^{0.5} \cdot h_{ef}^{1.5}$).

R-KEX-II WITH POST-INSTALLED REBAR

Premium pure epoxy resin approved for use with post-installed rebar connections

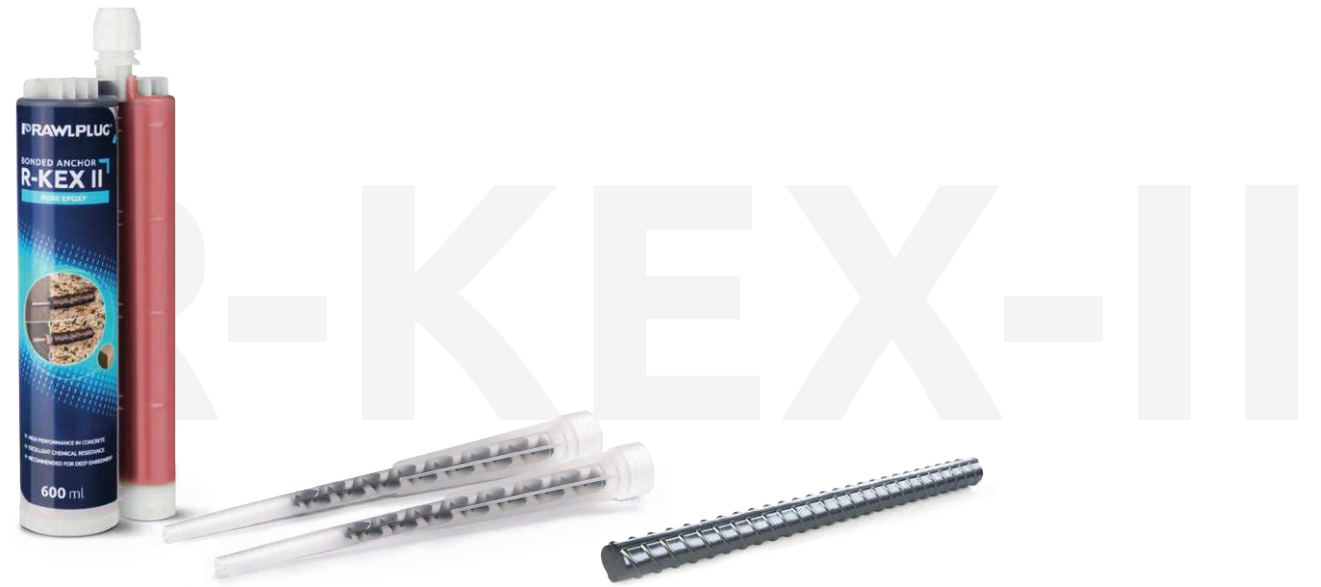

FEATURES AND BENEFITS

- Diamond and hammer drilling
- The strongest resin in the epoxy resin class
- Approved for use with post-installed rebars concrete (EAD 330087-00-0601)
- Suitable for use in dry and wet substrates including flooded holes
- High depth of anchoring up to 2,5 m for rebar applications
- Very high chemical resistance – suitable for applications exposed to influence of various agents (industrial or marine environment)
- Minimal shrinkage provides option of use in diamond-drilled holes and oversized holes
- Extended working time ensures easy installation of metal components (up to 30 min. in 20°C)
- For use in positive temperatures

APPLICATIONS

- Post-installed rebar connections
- Rebar
- Rebar missed-outs
- Extending existing buildings and structures.
- Renovation and modernization of bridges, buildings.
- Safety barriers
- Barriers
- Platforms

BASE MATERIALS

- Approved for use in:
 - Concrete C12/15-C50/60

INSTALLATION GUIDE

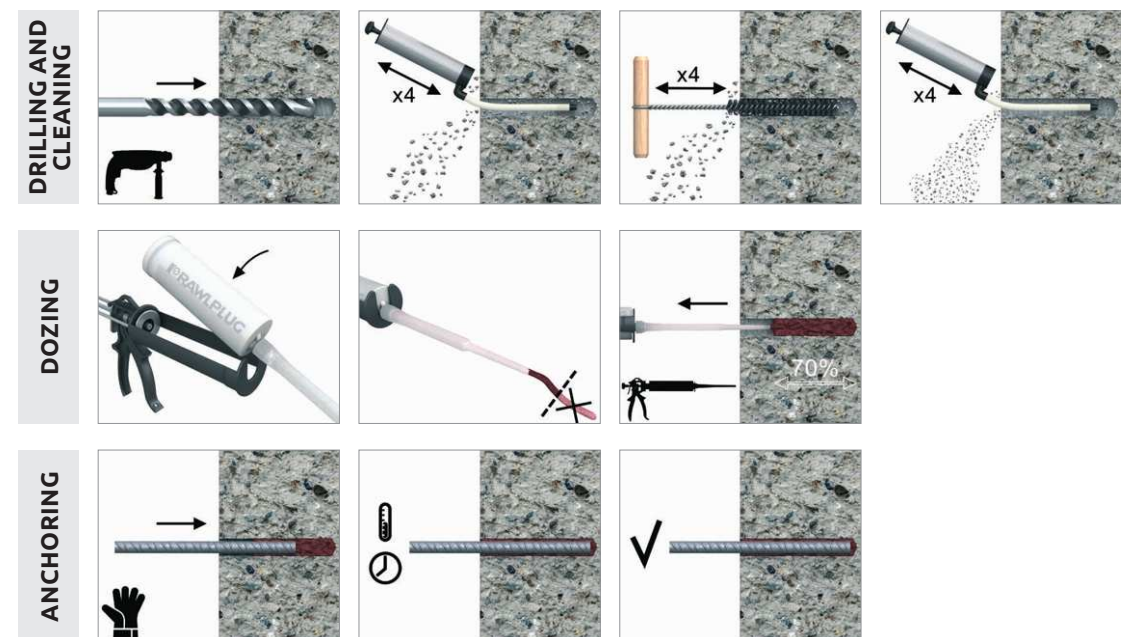

R-KEX-II WITH POST-INSTALLED REBAR

INSTALLATION GUIDE

1. Drill hole to the required diameter and depth for rebar size being used.
2. Clean the hole with brush and hand pump at least four times each. It is very important and necessary before installation.
3. Insert cartridge into gun and attach nozzle.
4. Dispense to waste until even colour is obtained.
5. Insert the mixer nozzle to the bottom of the drill hole and inject resin, slowly withdrawing the nozzle as the hole is filled to 70% of its depth.
6. Immediately insert the rebar, slowly and with slight twisting motion. Remove any excess resin around the hole before it sets and leave it undisturbed until the curing time elapses.

PRODUCT INFORMATION

Product Code	Resin	Description / Resin Type	Volume
			[ml]
R-KEX-II-385	R-KEX II	Epoxy Resin	385
R-KEX-II-600			600

INSTALLATION DATA

POST INSTALLED REBARS

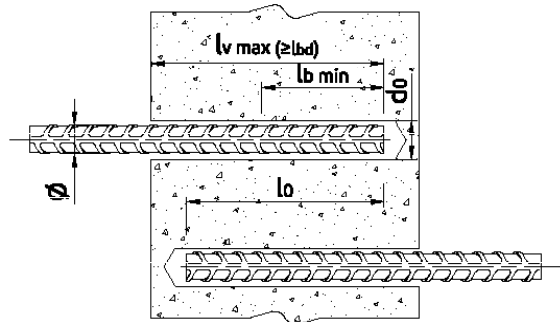

Size		Ø8	Ø10	Ø12	Ø13	Ø14	Ø16	Ø18	Ø20	Ø22	Ø25	Ø28	Ø30	Ø32	Ø34	Ø36	Ø40
Rebar diameter	d _s [mm]	8	10	12	13	14	16	18	20	22	25	28	30	32	34	36	40
Hole diameter in substrate	d ₀ [mm]	12	14	16	16	18	20	22	25	26	30	35	35	40	45	45	50
Brush diameter	- [mm]	14	16	18	18	20	22	24	27	27	32	37	37	42	47	47	52
Min. anchorage length	l _{b, min.} [mm]	115	145	170	185	200	230	260	285	315	355	400	420	455	485	510	570
Min. lap length (overlap splice)	l _{v, min.} [mm]	200	215	260	270	300	345	430	430	470	535	600	640	690	725	770	855
Max. anchorage length	l _{v, max.} [mm]	400	500	600	700	700	800	1000	1000	1100	1200	1400	1500	2500	2000	2000	2000

Minimum working and curing time

Resin temperature	Concrete temperature	Curing time*	Working time
[°C]	[°C]	[min]	[min]
5	5	2880	150
10	10	1080	120
20	20	480	35
25	30	300	12

*For wet concrete the curing time must be doubled

R-KEX-II WITH POST-INSTALLED REBAR

MECHANICAL PROPERTIES

POST INSTALLED REBARS

Size		Ø8	Ø10	Ø12	Ø13	Ø14	Ø16	Ø18	Ø20	Ø22	Ø25	Ø28	Ø30	Ø32	Ø34	Ø36	Ø40
f_{yk} = 410 (e.g. 34GS acc. to EC2)																	
Nominal yield strength - tension	f _{yk} [N/mm ²]	410	410	410	410	410	410	410	410	410	410	410	410	410	410	410	410
Cross sectional area - tension	A _s [mm ²]	50.3	78.5	113.1	132.7	153.9	201.1	254.5	314.2	380.1	490.9	615.8	706.9	804.2	907.9	1017.9	1256.6
f_{yk} = 420 (e.g. G-60 acc. to ASTM 615)																	
Nominal yield strength - tension	f _{yk} [N/mm ²]	420	420	420	420	420	420	420	420	420	420	420	420	420	420	420	420
Cross sectional area - tension	A _s [mm ²]	50.3	78.5	113.1	132.7	153.9	201.1	254.5	314.2	380.1	490.9	615.8	706.9	804.2	907.9	1017.9	1256.6
f_{yk} = 460 (e.g. 460 B acc. to BS 4449)																	
Nominal yield strength - tension	f _{yk} [N/mm ²]	460	460	460	460	460	460	460	460	460	460	460	460	460	460	460	460
Cross sectional area - tension	A _s [mm ²]	50.3	78.5	113.1	132.7	153.9	201.1	254.5	314.2	380.1	490.9	615.8	706.9	804.2	907.9	1017.9	1256.6
f_{yk} = 500 (e.g. B 500 SP acc. to EC2; 500 B acc. to BS 4449; B 500 B acc. to SS 560)																	
Nominal yield strength - tension	f _{yk} [N/mm ²]	500	500	500	500	500	500	500	500	500	500	500	500	500	500	500	500
Cross sectional area - tension	A _s [mm ²]	50.3	78.5	113.1	132.7	153.9	201.1	254.5	314.2	380.1	490.9	615.8	706.9	804.2	907.9	1017.9	1256.6
f_{yk} = 600 (e.g. B 600 B acc. to SS 560)																	
Nominal yield strength - tension	f _{yk} [N/mm ²]	600	600	600	600	600	600	600	600	600	600	600	600	600	600	600	600
Cross sectional area - tension	A _s [mm ²]	50.3	78.5	113.1	132.7	153.9	201.1	254.5	314.2	380.1	490.9	615.8	706.9	804.2	907.9	1017.9	1256.6

BASIC PERFORMANCE DATA

DESIGN RESISTANCE [kN] for l _{bd} [mm] - CONCRETE C20/25, NOMINAL YIELD STRENGTH FOR TENSION - f _{yk} = 410 [N/mm ²]																			
Size d _s [mm]	c _f /Ø	100	150	200	250	300	400	500	600	700	800	900	1000	1250	1500	2000	2500	Loads F _{Ed,yield} [kN]	Anchorage l _{bd,yield} [mm]
8	α2=0,7	8,3	12,4	16,5	17,9													17,9	217,0
8	α2=1,0	5,8	8,7	11,6	14,5	17,3	17,9											17,9	310,0
10	α2=0,7		15,5	20,6	25,8	28,0												28,0	271,3
10	α2=1,0		10,8	14,5	18,1	21,7	28,0											28,0	387,5
12	α2=0,7		18,6	24,8	31,0	37,2	40,3											40,3	325,5
12	α2=1,0		13,0	17,3	21,7	26,0	34,7	40,3										40,3	465,0
13	α2=0,7			26,8	33,5	40,3	47,3											47,3	352,6
13	α2=1,0			18,8	23,5	28,2	37,6	47,0	47,3									47,3	503,8
14	α2=0,7			28,9	36,1	43,4	54,9											54,9	379,8
14	α2=1,0			20,2	25,3	30,3	40,5	50,6	54,9									54,9	542,5
16	α2=0,7			33,0	41,3	49,5	66,1	71,7										71,7	434,0
16	α2=1,0			23,1	28,9	34,7	46,2	57,8	69,4	71,7								71,7	620,0
18	α2=0,7				46,5	55,7	74,3	90,7										90,7	488,3
18	α2=1,0				32,5	39,0	52,0	65,0	78,0	90,7								90,7	697,5
20	α2=0,7				51,6	61,9	82,6	103,2	112,0									112,0	542,5
20	α2=1,0				36,1	43,4	57,8	72,3	86,7	101,2	112,0							112,0	775,0
22	α2=0,7					68,1	90,8	113,5	135,5									135,5	596,8
22	α2=1,0	-	-			47,7	63,6	79,5	95,4	111,3	127,2	135,5						135,5	852,6
25	α2=0,7	-	-				77,4	103,2	129,0	154,8	175,0							175,0	678,2
25	α2=1,0	-	-				54,2	72,3	90,3	108,4	126,4	144,5	162,6	175,0				175,0	968,8
28	α2=0,7	-	-					115,6	144,5	173,4	202,3	219,5						219,5	759,5
28	α2=1,0	-	-					80,9	101,2	121,4	141,6	161,9	182,1	202,3	219,5			219,5	1 085,1
30	α2=0,7	-	-					123,9	154,8	185,8	216,8	247,7	252,0					252,0	813,8
30	α2=1,0	-	-					86,7	108,4	130,1	151,7	173,4	195,1	216,8	252,0			252,0	1 162,6
32	α2=0,7	-	-					132,1	165,2	198,2	231,2	264,3	286,7					286,7	868,1
32	α2=1,0	-	-					92,5	115,6	138,7	161,9	185,0	208,1	231,2	286,7			286,7	1 240,1
34	α2=0,7	-	-	-				140,4	175,5	210,6	245,7	280,8	315,9	323,7				323,7	922,3
34	α2=1,0	-	-	-				98,3	122,8	147,4	172,0	196,5	221,1	245,7	307,1	323,7		323,7	1 317,6
36	α2=0,7	-	-	-	-				185,8	223,0	260,1	260,1	297,3	334,4	362,9			362,9	976,6
36	α2=1,0	-	-	-	-				130,1	156,1	182,1	208,1	234,1	260,1	325,2	362,9		362,9	1 395,1
40	α2=0,7	-	-	-	-				179,5	215,4	251,3	287,2	323,1	359,0	448,0	-		448,0	1 247,8
40	α2=1,0	-	-	-	-				125,7	150,8	175,9	201,1	226,2	251,3	314,2	377,0	448,0	448,0	1 782,6

R-KEX-II WITH POST-INSTALLED REBAR

BASIC PERFORMANCE DATA (cont.)

DESIGN RESISTANCE [kN] for l_{bd} [mm] – CONCRETE C50/60, NOMINAL YIELD STRENGTH FOR TENSION - $f_{yk} = 410$ [N/mm ²]																			
Size d_s [mm]	c_f/ϕ	100	150	200	250	300	400	500	600	700	800	900	1000	1250	1500	2000	2500	Loads $F_{Ed,yield}$ [kN]	Anchorage $l_{bd,yield}$ [mm]
8	a2=0,7	15,4	17,9															17,9	116,1
8	a2=1,0	10,8	16,2	17,9														17,9	165,8
10	a2=0,7	19,3	28,0															28,0	145,1
10	a2=1,0	13,5	20,3	27,0	28,0													28,0	207,3
12	a2=0,7		34,7	40,3														40,3	174,1
12	a2=1,0		24,3	32,4	40,3													40,3	248,7
13	a2=0,7		37,6	47,3														47,3	188,6
13	a2=1,0		26,3	35,1	43,9	47,3												47,3	269,5
14	a2=0,7		40,5	54,0	54,9													54,9	203,1
14	a2=1,0		28,4	37,8	47,3	54,9												54,9	290,2
16	a2=0,7			57,4	71,7													71,7	249,6
16	a2=1,0			40,2	50,3	60,3	71,7											71,7	356,5
18	a2=0,7			64,6	80,8	90,7												90,7	280,8
18	a2=1,0			45,2	56,5	67,9	90,5	90,7										90,7	401,1
20	a2=0,7			66,4	83,0	99,6	112,0											112,0	337,3
20	a2=1,0			46,5	58,1	69,7	93,0	112,0										112,0	481,8
22	a2=0,7				91,3	109,6	135,5											135,5	371,0
22	a2=1,0				63,9	76,7	102,3	127,9	135,5									135,5	530,0
25	a2=0,7				95,4	114,4	152,6	175,0										175,0	458,8
25	a2=1,0				66,8	80,1	106,8	133,5	160,2	175,0								175,0	655,4
28	a2=0,7					128,2	170,9	213,6	219,5									219,5	513,8
28	a2=1,0					89,7	119,6	149,5	179,4	209,4	219,5							219,5	734,0
30	a2=0,7						121,2	161,6	202,0	242,4	252,0							252,0	623,9
30	a2=1,0						84,8	113,1	141,4	169,6	197,9	226,2	252,0					252,0	891,3
32	a2=0,7							155,1	193,9	232,7	271,4	286,7						286,7	739,5
32	a2=1,0							108,6	135,7	162,9	190,0	217,1	244,3	271,4	286,7			286,7	1056,4
34	a2=0,7							164,8	206,0	247,2	288,4	323,7						323,7	785,7
34	a2=1,0							115,4	144,2	173,0	201,9	203,7	259,6	288,4	323,7			323,7	1122,4
36	a2=0,7								185,8	223,0	260,1	297,3	334,4	362,9				362,9	976,6
36	a2=1,0								130,1	156,1	182,1	208,1	234,1	260,1	325,2	362,9		362,9	1395,1
40	a2=0,7								179,5	215,4	251,3	287,2	323,1	359,0	448,0			448,0	1247,8
40	a2=1,0								125,7	150,8	175,9	201,1	226,2	251,3	314,2	377,0	448,0	448,0	1782,6

DESIGN RESISTANCE [kN] for l_{bd} [mm] – CONCRETE C50/60, NOMINAL YIELD STRENGTH FOR TENSION - $f_{yk} = 410$ [N/mm ²]																			
Size d_s [mm]	c_f/ϕ	100	150	200	250	300	400	500	600	700	800	900	1000	1250	1500	2000	2500	Loads $F_{Ed,yield}$ [kN]	Anchorage $l_{bd,yield}$ [mm]
8	a2=0,7	8,3	12,4	16,5	18,4	-	-	-	-	-	-	-	-	-	-	-	-	18,4	222,3
8	a2=1,0	5,8	8,7	11,6	14,5	17,3	18,4	-	-	-	-	-	-	-	-	-	-	18,4	317,6
10	a2=0,7	-	15,5	20,6	25,8	28,7	-	-	-	-	-	-	-	-	-	-	-	28,7	277,9
10	a2=1,0	-	10,8	14,5	18,1	21,7	28,7	-	-	-	-	-	-	-	-	-	-	28,7	397,0
12	a2=0,7	-	18,6	24,8	31,0	37,2	41,3	-	-	-	-	-	-	-	-	-	-	41,3	333,5
12	a2=1,0	-	13,0	17,3	21,7	26,0	34,7	41,3	-	-	-	-	-	-	-	-	-	41,3	476,4
13	a2=0,7	-	-	26,8	33,5	40,3	48,5	-	-	-	-	-	-	-	-	-	-	48,5	361,2
13	a2=1,0	-	-	18,8	23,5	28,2	37,6	47,0	48,5	-	-	-	-	-	-	-	-	48,5	516,1
14	a2=0,7	-	-	28,9	36,1	43,4	56,2	-	-	-	-	-	-	-	-	-	-	56,2	389,0
14	a2=1,0	-	-	20,2	25,3	30,3	40,5	50,6	56,2	-	-	-	-	-	-	-	-	56,2	555,8
16	a2=0,7	-	-	33,0	41,3	49,5	66,1	73,4	-	-	-	-	-	-	-	-	-	73,4	444,6
16	a2=1,0	-	-	23,1	28,9	34,7	46,2	57,8	69,4	73,4	-	-	-	-	-	-	-	73,4	635,2
18	a2=0,7	-	-	-	46,5	55,7	74,3	92,9	92,9	-	-	-	-	-	-	-	-	92,9	500,2
18	a2=1,0	-	-	-	32,5	39,0	52,0	65,0	78,0	91,0	92,9	-	-	-	-	-	-	92,9	714,6
20	a2=0,7	-	-	-	51,6	61,9	82,6	103,2	114,8	-	-	-	-	-	-	-	-	114,8	555,8
20	a2=1,0	-	-	-	36,1	43,4	57,8	72,3	86,7	101,2	114,8	-	-	-	-	-	-	114,8	794,0
22	a2=0,7	-	-	-	-	68,1	90,8	113,5	138,8	-	-	-	-	-	-	-	-	138,8	611,3
22	a2=1,0	-	-	-	-	47,7	63,6	79,5	95,4	111,3	127,2	138,8	-	-	-	-	-	138,8	873,3
25	a2=0,7	-	-	-	-	77,4	103,2	129,0	154,8	179,3	-	-	-	-	-	-	-	179,3	694,7
25	a2=1,0	-	-	-	-	54,2	72,3	90,3	108,4	126,4	144,5	162,6	179,3	-	-	-	-	179,3	992,4
28	a2=0,7	-	-	-	-	-	115,6	144,5	173,4	202,3	224,9	-	-	-	-	-	-	224,9	778,1
28	a2=1,0	-	-	-	-	-	80,9	101,2	121,4	141,6	161,9	182,1	202,3	224,9	-	-	-	224,9	1111,5
30	a2=0,7	-	-	-	-	-	123,9	154,8	185,8	216,8	247,7	258,2	-	-	-	-	-	258,2	833,6
30	a2=1,0	-	-	-	-	-	86,7	108,4	130,1	151,7	173,4	195,1	216,8	258,2	-	-	-	258,2	1190,9
32	a2=0,7	-	-	-	-	-	132,1	165,2	198,2	231,2	264,3	293,7	-	-	-	-	-	293,7	889,2
32	a2=1,0	-	-	-	-	-	92,5	115,6	138,7	161,9	185,0	208,1	231,2	289,0	293,7	-	-	293,7	1270,3
34	a2=0,7	-	-	-	-	-	-	175,5	210,6	245,7	280,8	315,9	331,6	-	-	-	-	331,6	944,8
34	a2=1,0	-	-	-	-	-	-	122,8	147,4	172,0	196,5	221,1	245,7	307,1	331,6	-	-	331,6	1349,7
36	a2=0,7	-	-	-	-	-	-	185,8	223,0	260,1	297,3	334,4	371,6	371,7	-	-	-	371,7	1000,4
36	a2=1,0	-	-	-	-	-	-	130,1	156,1	182,1	208,1	234,1	260,1	325,2	371,7	-	-	371,7	1429,1
40	a2=0,7	-	-	-	-	-	-	215,4	251,3	287,2	323,1	359,0	448,8	458,9	-	-	-	458,9	1278,3
40	a2=1,0	-	-	-	-	-	-	150,8	175,9	201,1	226,2	251,3	314,2	377,0	458,9	-	-	458,9	1826,1

R-KEX-II WITH POST-INSTALLED REBAR

BASIC PERFORMANCE DATA (cont.)

DESIGN RESISTANCE [kN] for l_{bd} [mm] – CONCRETE C50/60, NOMINAL YIELD STRENGTH FOR TENSION - $f_{yk} = 420$ [N/mm ²]																				
Size d_s [mm]	c_f/ϕ	100	150	200	250	300	400	500	600	700	800	900	1000	1250	1500	2000	2500	Loads $F_{Ed,yield}$ [kN]	Anchorage $l_{bd,yield}$ [mm]	
8	a2=0,7	15,4	18,4	-	-	-	-	-	-	-	-	-	-	-	-	-	-	18,4	118,9	222,3
8	a2=1,0	10,8	16,2	18,4	-	-	-	-	-	-	-	-	-	-	-	-	-	18,4	169,9	317,6
10	a2=0,7	19,3	28,7	-	-	-	-	-	-	-	-	-	-	-	-	-	-	28,7	148,6	277,9
10	a2=1,0	13,5	20,3	27,0	28,7	-	-	-	-	-	-	-	-	-	-	-	-	28,7	212,3	397,0
12	a2=0,7	-	34,7	41,3	-	-	-	-	-	-	-	-	-	-	-	-	-	41,3	178,4	333,5
12	a2=1,0	-	24,3	32,4	40,5	41,3	-	-	-	-	-	-	-	-	-	-	-	41,3	254,8	476,4
13	a2=0,7	-	37,6	48,5	-	-	-	-	-	-	-	-	-	-	-	-	-	48,5	193,2	361,2
13	a2=1,0	-	26,3	35,1	43,9	48,5	-	-	-	-	-	-	-	-	-	-	-	48,5	276,0	516,1
14	a2=0,7	-	40,5	54,0	56,2	-	-	-	-	-	-	-	-	-	-	-	-	56,2	208,1	389,0
14	a2=1,0	-	28,4	37,8	47,3	56,2	-	-	-	-	-	-	-	-	-	-	-	56,2	297,3	555,8
16	a2=0,7	-	-	57,4	71,7	73,4	-	-	-	-	-	-	-	-	-	-	-	73,4	255,7	444,6
16	a2=1,0	-	-	40,2	50,3	60,3	73,4	-	-	-	-	-	-	-	-	-	-	73,4	365,2	635,2
18	a2=0,7	-	-	64,6	80,8	92,9	-	-	-	-	-	-	-	-	-	-	-	92,9	287,6	500,2
18	a2=1,0	-	-	45,2	56,5	67,9	90,5	92,9	-	-	-	-	-	-	-	-	-	92,9		

R-KEX-II WITH POST-INSTALLED REBAR

BASIC PERFORMANCE DATA (cont.)

DESIGN RESISTANCE [kN] for l_{bd} [mm] – CONCRETE C50/60, NOMINAL YIELD STRENGTH FOR TENSION - $f_{yk} = 460$ [N/mm ²]																			
Size d_s [mm]	c_f/ϕ	100	150	200	250	300	400	500	600	700	800	900	1000	1250	1500	2000	2500	Loads $F_{Ed,yield}$ [kN]	Anchorage $l_{bd,yield}$ [mm]
8	a2=0,7	15,4	20,1	-	-	-	-	-	-	-	-	-	-	-	-	-	-	20,1	130,2
8	a2=1,0	10,8	16,2	20,1	-	-	-	-	-	-	-	-	-	-	-	-	-	20,1	186,0
10	a2=0,7	19,3	28,9	31,4	-	-	-	-	-	-	-	-	-	-	-	-	-	31,4	162,8
10	a2=1,0	13,5	20,3	27,0	31,4	-	-	-	-	-	-	-	-	-	-	-	-	31,4	232,6
12	a2=0,7	-	34,7	45,2	-	-	-	-	-	-	-	-	-	-	-	-	-	45,2	195,3
12	a2=1,0	-	24,3	32,4	40,5	45,2	-	-	-	-	-	-	-	-	-	-	-	45,2	279,1
13	a2=0,7	-	37,6	50,2	53,1	-	-	-	-	-	-	-	-	-	-	-	-	53,1	211,6
13	a2=1,0	-	26,3	35,1	43,9	52,7	53,1	-	-	-	-	-	-	-	-	-	-	53,1	302,3
14	a2=0,7	-	40,5	54,0	61,6	-	-	-	-	-	-	-	-	-	-	-	-	61,6	227,9
14	a2=1,0	-	28,4	37,8	47,3	56,7	61,6	-	-	-	-	-	-	-	-	-	-	61,6	325,6
16	a2=0,7	-	57,4	71,8	80,4	-	-	-	-	-	-	-	-	-	-	-	-	80,4	280,0
16	a2=1,0	-	40,2	50,3	60,3	80,4	80,4	-	-	-	-	-	-	-	-	-	-	80,4	400,0
18	a2=0,7	-	64,6	80,8	96,9	101,8	-	-	-	-	-	-	-	-	-	-	-	101,8	315,0
18	a2=1,0	-	45,2	56,5	67,9	90,5	101,8	-	-	-	-	-	-	-	-	-	-	101,8	450,0
20	a2=0,7	-	66,4	83,0	99,6	125,7	-	-	-	-	-	-	-	-	-	-	-	125,7	378,4
20	a2=1,0	-	46,5	58,1	69,7	93,0	116,2	125,7	-	-	-	-	-	-	-	-	-	125,7	540,5
22	a2=0,7	-	91,3	109,6	146,1	152,1	-	-	-	-	-	-	-	-	-	-	-	152,1	416,2
22	a2=1,0	-	63,9	76,7	102,3	127,9	152,1	-	-	-	-	-	-	-	-	-	-	152,1	594,6
25	a2=0,7	-	95,4	114,4	152,6	190,7	196,4	-	-	-	-	-	-	-	-	-	-	196,4	514,7
25	a2=1,0	-	66,8	80,1	106,8	133,5	160,2	186,9	196,4	-	-	-	-	-	-	-	-	196,4	735,3
28	a2=0,7	-	128,2	170,9	213,6	246,3	-	-	-	-	-	-	-	-	-	-	-	246,3	576,5
28	a2=1,0	-	89,7	119,6	149,5	179,4	209,4	239,3	246,3	-	-	-	-	-	-	-	-	246,3	823,5
30	a2=0,7	-	121,2	161,6	202,0	242,4	282,7	-	-	-	-	-	-	-	-	-	-	282,7	700,0
30	a2=1,0	-	84,8	113,1	141,4	169,6	197,9	226,2	254,5	282,7	-	-	-	-	-	-	-	282,7	1 000,0
32	a2=0,7	-	155,1	193,9	232,7	271,4	310,2	321,7	-	-	-	-	-	-	-	-	-	321,7	829,6
32	a2=1,0	-	108,6	135,7	162,9	190,0	217,1	244,3	271,4	321,7	-	-	-	-	-	-	-	321,7	1 185,2
34	a2=0,7	-	164,8	206,0	247,2	288,4	329,6	363,2	-	-	-	-	-	-	-	-	-	363,2	881,5
34	a2=1,0	-	115,4	144,2	173,0	201,9	230,7	259,6	288,4	360,5	363,2	-	-	-	-	-	-	363,2	1 259,3
36	a2=0,7	-	185,8	223,0	260,1	297,3	334,4	371,6	407,2	-	-	-	-	-	-	-	-	407,2	1 095,7
36	a2=1,0	-	130,1	156,1	182,1	208,1	234,1	260,1	325,2	390,2	407,2	-	-	-	-	-	-	407,2	1 565,2
40	a2=0,7	-	215,4	251,3	287,2	323,1	359,0	448,8	502,6	-	-	-	-	-	-	-	-	502,6	1 400,0
40	a2=1,0	-	150,8	175,9	201,1	226,2	251,3	314,2	377,0	502,6	-	-	-	-	-	-	-	502,6	2 000,0

DESIGN RESISTANCE [kN] for l_{bd} [mm] – CONCRETE C20/25, NOMINAL YIELD STRENGTH FOR TENSION - $f_{yk} = 500$ [N/mm ²]																			
Size d_s [mm]	c_f/ϕ	100	150	200	250	300	400	500	600	700	800	900	1000	1250	1500	2000	2500	Loads $F_{Ed,yield}$ [kN]	Anchorage $l_{bd,yield}$ [mm]
8	a2=0,7	-	12,4	16,5	20,6	21,9	-	-	-	-	-	-	-	-	-	-	-	21,9	264,7
8	a2=1,0	-	8,7	11,6	14,5	17,3	21,9	-	-	-	-	-	-	-	-	-	-	21,9	378,1
10	a2=0,7	-	15,5	20,6	25,8	31,0	34,1	-	-	-	-	-	-	-	-	-	-	34,1	330,8
10	a2=1,0	-	10,8	14,5	18,1	21,7	28,9	34,1	-	-	-	-	-	-	-	-	-	34,1	472,6
12	a2=0,7	-	24,8	31,0	37,2	49,2	-	-	-	-	-	-	-	-	-	-	-	49,2	397,0
12	a2=1,0	-	17,3	21,7	26,0	34,7	43,4	49,2	-	-	-	-	-	-	-	-	-	49,2	567,1
13	a2=0,7	-	26,8	33,5	40,3	53,7	57,7	-	-	-	-	-	-	-	-	-	-	57,7	430,1
13	a2=1,0	-	18,8	23,5	28,2	37,6	47,0	56,4	57,7	-	-	-	-	-	-	-	-	57,7	614,4
14	a2=0,7	-	28,9	36,1	43,4	57,8	66,9	-	-	-	-	-	-	-	-	-	-	66,9	463,1
14	a2=1,0	-	20,2	25,3	30,3	40,5	50,6	60,7	66,9	-	-	-	-	-	-	-	-	66,9	661,6
16	a2=0,7	-	41,3	49,5	66,1	82,6	87,4	-	-	-	-	-	-	-	-	-	-	87,4	529,3
16	a2=1,0	-	28,9	34,7	46,2	57,8	69,4	80,9	87,4	-	-	-	-	-	-	-	-	87,4	756,1
18	a2=0,7	-	55,7	74,3	92,9	110,6	-	-	-	-	-	-	-	-	-	-	-	110,6	595,5
18	a2=1,0	-	39,0	52,0	65,0	78,0	91,0	104,0	110,6	-	-	-	-	-	-	-	-	110,6	850,7
20	a2=0,7	-	61,9	82,6	103,2	123,9	136,6	-	-	-	-	-	-	-	-	-	-	136,6	661,6
20	a2=1,0	-	43,4	57,8	72,3	86,7	101,2	115,6	130,1	151,7	173,4	195,1	216,8	271,0	307,3	-	-	307,3	1 417,8
22	a2=0,7	-	90,8	113,5	136,3	159,0	165,3	-	-	-	-	-	-	-	-	-	-	165,3	727,8
22	a2=1,0	-	63,6	79,5	95,4	111,3	127,2	143,1	159,0	-	-	-	-	-	-	-	-	165,3	1 039,7
25	a2=0,7	-	103,2	129,0	154,8	180,6	206,4	213,4	-	-	-	-	-	-	-	-	-	213,4	827,0
25	a2=1,0	-	72,3	90,3	108,4	126,4	144,5	162,6	180,6	-	-	-	-	-	-	-	-	213,4	1 181,5
28	a2=0,7	-	115,6	144,5	173,4	202,3	231,2	260,1	267,7	-	-	-	-	-	-	-	-	267,7	926,3
28	a2=1,0	-	80,9	101,2	121,4	141,6	161,9	182,1	202,3	252,9	-	-	-	-	-	-	-	267,7	1 323,3
30	a2=0,7	-	154,8	185,8	216,8	247,7	278,7	307,3	-	-	-	-	-	-	-	-	-	307,3	992,4
30	a2=1,0	-	108,4	130,1	151,7	173,4	195,1	216,8	271,0	307,3	-	-	-	-	-	-	-	307,3	1 417,8
32	a2=0,7	-	165,2	198,2	231,2	264,3	297,3	330,3	349,7	-	-	-	-	-	-	-	-	349,7	1 058,6
32	a2=1,0	-	115,6	138,7	161,9	185,0	208,1	231,2	289,0	346,8	349,7	-	-	-	-	-	-	349,7	1 512,3
34	a2=0,7	-	175,5	210,6	245,7	280,8	315,9	351,0	394,7	-	-	-	-	-	-	-	-	394,7	1 124,8
34	a2=1,0	-	122,8	147,4	172,0	196,5	221,1	245,7	307,1	368,5	394,7	-	-	-	-	-	-	394,7	1 606,8
36	a2=0,7	-	223,0	260,1	297,3	334,4	371,6	442,6	-	-	-	-	-	-	-	-	-	442,6	1 190,9
36	a2=1,0	-	156,1	182,1	208,1	234,1	260,1	325,2	390,2	442,6	-	-	-	-	-	-	-	442,6	1 701,3
40	a2=0,7	-	215,4	251,3	287,2	323,1	359,0	448,8	538,6	546,3	-	-	-	-	-	-	-	546,3	1 521,7
40	a2=1,0	-	150,8	175,9	201,1	226,2	251,3	314,2	377,0	502,7	-	-	-	-	-	-	-	546,3	2 173,9

R-KEX-II WITH POST-INSTALLED REBAR

BASIC PERFORMANCE DATA (cont.)

DESIGN RESISTANCE [kN] for l_{bd} [mm] – CONCRETE C50/60, NOMINAL YIELD STRENGTH FOR TENSION - $f_{yk} = 500$ [N/mm ²]																			
Size d_s [mm]	c_f/ϕ	100	150	200	250	300	400	500	600	700	800	900	1000	1250	1500	2000	2500	Loads $F_{Ed,yield}$ [kN]	Anchorage $l_{bd,yield}$ [mm]
8	a2=0,7	-	12,4	16,5	20,6	21,9	-	-	-	-	-	-	-	-	-	-	-	21,9	264,7
8	a2=1,0	-	8,7	11,6	14,5	17,3	21,9	-	-	-	-	-	-	-	-	-	-	21,9	378,1
10	a2=0,7	-	15,5	20,6	25,8	31,0	34,1	-	-	-	-	-	-	-	-	-	-	34,1	330,8
10	a2=1,0	-	10,8	14,5	18,1	21,7	28,9	34,1	-	-	-	-	-	-	-	-	-	34,1	472,6
12	a2=0,7	-	24,8	31,0	37,2	49,2	-	-	-	-	-	-	-	-	-	-	-	49,2	397,0
12	a2=1,0	-	17,3	21,7	26,0	34,7	43,4	49,2	-	-	-	-	-	-	-	-	-	49,2	567,1
13	a2=0,7	-	26,8	33,5	40,3	53,7	57,7	-	-	-	-	-	-	-	-	-	-	57,7	430,1
13	a2=1,0	-	18,8	23,5	28,2	37,6	47,0	56,4	57,7	-	-	-	-	-	-	-	-	57,7	614,4
14	a2=0,7	-	28,9	36,1	43,4	57,8	66,9	-	-	-	-	-	-	-	-	-	-	66,9	463,1
14	a2=1,0	-	20,2	25,3	30,3	40,5	50,6	60,7	66,9	-	-	-	-	-	-	-	-	66,9	661,6
16	a2=0,7	-	41,3	49,5															

R-KEX-II WITH POST-INSTALLED REBAR

BASIC PERFORMANCE DATA (cont.)

DESIGN RESISTANCE [kN] for l_{bd} [mm] – CONCRETE C20/25, NOMINAL YIELD STRENGTH FOR TENSION - $f_{yk} = 600$ [N/mm ²]																			
Size d_s [mm]	c_f/ϕ	100	150	200	250	300	400	500	600	700	800	900	1000	1250	1500	2000	2500	Loads $F_{Ed,yield}$ [kN]	Anchorage $l_{bd,yield}$ [mm]
8	a2=0,7	-	12,4	16,5	20,6	24,8	26,2	-	-	-	-	-	-	-	-	-	-	26,2	317,6
8	a2=1,0	-	8,7	11,6	14,5	17,3	23,1	-	-	-	-	-	-	-	-	-	-	26,2	453,7
10	a2=0,7	-	-	20,6	25,8	31,0	41,0	-	-	-	-	-	-	-	-	-	-	41,0	397,0
10	a2=1,0	-	-	14,5	18,1	21,7	28,9	36,1	-	-	-	-	-	-	-	-	-	41,0	567,1
12	a2=0,7	-	-	-	31,0	37,2	49,5	59,0	-	-	-	-	-	-	-	-	-	59,0	476,4
12	a2=1,0	-	-	-	21,7	26,0	34,7	43,4	52,0	-	-	-	-	-	-	-	-	59,0	680,5
13	a2=0,7	-	-	-	33,5	40,3	53,7	67,1	69,3	-	-	-	-	-	-	-	-	69,3	516,1
13	a2=1,0	-	-	-	23,5	28,2	37,6	47,0	56,4	65,8	-	-	-	-	-	-	-	69,3	737,2
14	a2=0,7	-	-	-	36,1	43,4	57,8	72,3	80,3	-	-	-	-	-	-	-	-	80,3	555,8
14	a2=1,0	-	-	-	25,3	30,3	40,5	50,6	60,7	70,8	-	-	-	-	-	-	-	80,3	794,0
16	a2=0,7	-	-	-	49,5	66,1	82,6	99,1	104,9	-	-	-	-	-	-	-	-	104,9	635,2
16	a2=1,0	-	-	-	34,7	46,2	57,8	69,4	80,9	92,5	-	-	-	-	-	-	-	104,9	907,4
18	a2=0,7	-	-	-	-	-	74,3	92,9	111,5	130,1	132,8	-	-	-	-	-	-	132,8	714,6
18	a2=1,0	-	-	-	-	-	52,0	65,0	78,0	91,0	104,0	117,1	-	-	-	-	-	132,8	1020,8
20	a2=0,7	-	-	-	-	-	82,6	103,2	123,9	144,5	163,9	-	-	-	-	-	-	163,9	794,0
20	a2=1,0	-	-	-	-	-	57,8	72,3	86,7	101,2	115,6	130,1	144,5	-	-	-	-	163,9	1134,2
22	a2=0,7	-	-	-	-	-	90,8	113,5	136,3	159,0	181,7	198,3	-	-	-	-	-	198,3	873,3
22	a2=1,0	-	-	-	-	-	63,6	79,5	95,4	111,3	127,2	143,1	159,0	-	-	-	-	198,3	1247,6
25	a2=0,7	-	-	-	-	-	-	129,0	154,8	180,6	206,4	232,3	256,1	-	-	-	-	256,1	992,4
25	a2=1,0	-	-	-	-	-	-	90,3	108,4	126,4	144,5	162,6	180,6	-	-	-	-	256,1	1417,8
28	a2=0,7	-	-	-	-	-	-	144,5	173,4	202,3	231,2	260,1	289,0	321,3	-	-	-	321,3	1111,5
28	a2=1,0	-	-	-	-	-	-	101,2	121,4	141,6	161,9	182,1	202,3	252,9	-	-	-	321,3	1587,9
30	a2=0,7	-	-	-	-	-	-	-	185,8	216,8	247,7	278,7	309,7	368,8	-	-	-	368,8	1190,9
30	a2=1,0	-	-	-	-	-	-	-	130,1	151,7	173,4	195,1	216,8	271,0	325,2	-	-	368,8	1701,3
32	a2=0,7	-	-	-	-	-	-	-	198,2	231,2	264,3	297,3	330,3	412,9	419,6	-	-	419,6	1270,3
32	a2=1,0	-	-	-	-	-	-	-	138,7	161,9	185,0	208,1	231,2	289,0	346,8	419,6	-	419,6	1814,7
34	a2=0,7	-	-	-	-	-	-	-	210,6	245,7	280,8	315,9	351,0	438,7	473,7	-	-	473,7	1349,7
34	a2=1,0	-	-	-	-	-	-	-	147,4	172,0	196,5	221,1	245,7	307,1	368,5	473,7	-	473,7	1928,2
36	a2=0,7	-	-	-	-	-	-	-	-	260,1	297,3	334,4	371,6	464,5	531,1	-	-	531,1	1429,1
36	a2=1,0	-	-	-	-	-	-	-	-	182,1	208,1	234,1	260,1	325,2	390,2	520,2	-	531,1	2041,6
40	a2=0,7	-	-	-	-	-	-	-	-	-	287,2	323,1	359,0	448,8	538,6	655,6	-	655,6	1826,1
40	a2=1,0	-	-	-	-	-	-	-	-	-	201,1	226,2	251,3	314,2	377,0	502,7	-	655,6	2608,7

DESIGN RESISTANCE [kN] for l_{bd} [mm] – CONCRETE C50/60, NOMINAL YIELD STRENGTH FOR TENSION - $f_{yk} = 600$ [N/mm ²]																			
Size d_s [mm]	c_f/ϕ	100	150	200	250	300	400	500	600	700	800	900	1000	1250	1500	2000	2500	Loads $F_{Ed,yield}$ [kN]	Anchorage $l_{bd,yield}$ [mm]
8	a2=0,7	15,4	23,2	26,2	-	-	-	-	-	-	-	-	-	-	-	-	-	26,2	169,9
8	a2=1,0	10,8	16,2	21,6	26,2	-	-	-	-	-	-	-	-	-	-	-	-	26,2	242,7
10	a2=0,7	19,3	28,9	38,6	41,0	-	-	-	-	-	-	-	-	-	-	-	-	41,0	212,3
10	a2=1,0	13,5	20,3	27,0	33,8	40,5	41,0	-	-	-	-	-	-	-	-	-	-	41,0	303,3
12	a2=0,7	-	34,7	46,3	57,9	59,0	-	-	-	-	-	-	-	-	-	-	-	59,0	254,8
12	a2=1,0	-	24,3	32,4	40,5	48,6	59,0	-	-	-	-	-	-	-	-	-	-	59,0	364,0
13	a2=0,7	-	37,6	50,2	62,7	69,3	-	-	-	-	-	-	-	-	-	-	-	69,3	276,0
13	a2=1,0	-	26,3	35,1	43,9	52,7	69,3	-	-	-	-	-	-	-	-	-	-	69,3	394,3
14	a2=0,7	-	40,5	54,0	67,5	80,3	-	-	-	-	-	-	-	-	-	-	-	80,3	297,3
14	a2=1,0	-	28,4	37,8	47,3	56,7	75,6	80,3	-	-	-	-	-	-	-	-	-	80,3	424,7
16	a2=0,7	-	-	57,4	71,8	86,2	104,9	-	-	-	-	-	-	-	-	-	-	104,9	365,2
16	a2=1,0	-	-	40,2	50,3	60,3	80,4	100,5	104,9	-	-	-	-	-	-	-	-	104,9	521,7
18	a2=0,7	-	-	64,6	80,8	96,9	129,3	132,8	-	-	-	-	-	-	-	-	-	132,8	410,9
18	a2=1,0	-	-	45,2	56,5	67,9	90,5	113,1	132,8	-	-	-	-	-	-	-	-	132,8	587,0
20	a2=0,7	-	-	-	83,0	99,6	132,8	163,9	-	-	-	-	-	-	-	-	-	163,9	493,5
20	a2=1,0	-	-	-	58,1	69,7	93,0	116,2	139,5	162,7	163,9	-	-	-	-	-	-	163,9	705,1
22	a2=0,7	-	-	-	91,3	109,6	146,1	182,7	198,3	-	-	-	-	-	-	-	-	198,3	542,9
22	a2=1,0	-	-	-	63,9	76,7	102,3	127,9	153,4	179,0	198,3	-	-	-	-	-	-	198,3	775,6
25	a2=0,7	-	-	-	-	114,4	152,6	190,7	228,9	256,1	-	-	-	-	-	-	-	256,1	671,4
25	a2=1,0	-	-	-	-	80,1	106,8	133,5	160,2	186,9	213,6	240,3	256,1	-	-	-	-	256,1	959,1
28	a2=0,7	-	-	-	-	-	170,9	213,6	256,4	299,1	321,3	-	-	-	-	-	-	321,3	751,9
28	a2=1,0	-	-	-	-	-	119,6	149,5	179,4	209,4	239,3	269,2	299,1	321,3	-	-	-	321,3	1074,2
30	a2=0,7	-	-	-	-	-	161,6	202,0	242,4	282,7	323,1	363,5	368,8	-	-	-	-	368,8	913,0
30	a2=1,0	-	-	-	-	-	113,1	141,4	169,6	197,9	226,2	254,5	282,7	353,4	368,8	-	-	368,8	1304,3
32	a2=0,7	-	-	-	-	-	193,9	232,7	271,4	310,2	349,0	387,8	419,6	-	-	-	-	419,6	1082,1
32	a2=1,0	-	-	-	-	-	135,7	162,9	190,0	217,1	244,3	271,4	339,3	407,2	419,6	-	-	419,6	1545,9
34	a2=0,7	-	-	-	-	-	206,0	247,2	288,4	329,6	370,8	412,0	473,7	-	-	-	-	473,7	1149,8
34	a2=1,0	-	-	-	-	-	144,2	173,0	201,9	230,7	259,6	288,4	360,5	432,6	473,7	-	-	473,7	1642,5
36	a2=0,7	-	-	-	-	-	-	-	260,1	297,3	334,4	371,6	464,5	531,1	-	-	-	531,1	1429,1
36	a2=1,0	-	-	-	-	-	-	-	182,1	208,1	234,1	260,1	325,2	390,2	520,2	-	-	531,1	2041,6
40	a2=0,7	-	-	-	-	-	-	-	-	287,2	323,1	359,0	448,8	538,6	655,6	-	-	655,6	1826,1
40	a2=1,0	-	-	-	-	-	-	-	-	201,1	226,2	251,3	314,2	377,0	502,7	-	-	655,6	2608,7

R-KEX-II WITH POST-INSTALLED REBAR

DESIGN PERFORMANCE DATA

POST INSTALLED REBARS

Size	$\phi 8$	$\phi 10$	$\phi 12$	$\phi 13$	$\phi 14$	$\phi 16$	$\phi 18$	$\phi 20$	$\phi 22$	$\phi 25$	$\phi 28$	$\phi 30$	$\phi 32$	$\phi 34$	$\phi 36$	$\phi 40$
TENSION LOAD																
Mean ultimate bond resistance C12/15	f_{bd}	[N/mm ²]	1.60	1.60	1.60	1.60	1.60	1.60	1.60	1.60	1.60	1.60	1.60	1.60	1.60	1.60
Mean ultimate bond resistance C16/20	f_{bd}	[N/mm ²]	2.00	2.00	2.00	2.00	2.00	2.00	2.00	2.00	2.00	2.00	2.00	2.00	2.00	2.00
Mean ultimate bond resistance C20/25	f_{bd}	[N/mm ²]	2.30	2.30	2.30	2.30	2.30	2.30	2.30	2.30	2.30	2.30	2.30	2.30	2.30	2.00
Mean ultimate bond resistance C25/30	f_{bd}	[N/mm ²]	2.70	2.70	2.70	2.70	2.70	2.70	2.70	2.70	2.70	2.70	2.70	2.70	2.30	2.00
Mean ultimate bond resistance C30/37	f_{bd}	[N/mm ²]	3.00	3.00	3.00	3.00	3.00	3.00	3.00	3.00	3.00	3.00	3.00	2.70	2.70	2.30
Mean ultimate bond resistance C35/45	f_{bd}	[N/mm ²]	3.40	3.40	3.40	3.40	3.40	3.40	3.40	3.40	3.40	3.40	3.40	3.00	2.70	2.30
Mean ultimate bond resistance C40/50	f_{bd}	[N/mm ²]	3.70	3.70	3.70	3.70	3.70	3.70	3.70	3.70	3.70	3.40	3.00	2.70	2.70	2.00
Mean ultimate bond resistance C45/55	f_{bd}	[N/mm ²]	4.00	4.00	4.00	4.00	4									

R-KEX-I EPOXY RESIN POST-INSTALLED REBARS

High performance epoxy resin approved for use with post-installed rebar connections.
Available in Asia-Pacific region



FEATURES AND BENEFITS

- High performance epoxy resin approved for use with post-installed rebar connections.
- Approved for use with post-installed rebar concrete (EAD 330087-00-0601).
- The rebars may be used in dry or wet concrete.
- High depth of anchoring up to 2,5 m for rebar applications.
- Extended working time ensures easy installation.
- Recommended application at positive temperatures
- Accessories dedicated for deep anchoring (brushes, extensions, piston plug, air adapter and power guns).
- Very high chemical resistance – suitable for applications exposed to influence of various agents (industrial or marine environment).
- Minimal shrinkage

APPLICATIONS

- Post-installed rebar connections
- Rebar
- Rebar missed-outs
- Extending existing buildings and structures
- Renovation and modernization of bridges, buildings
- Platforms
- Barriers

BASE MATERIALS

- Approved for use in:
- Concrete
 - C12/15-C50/60

INSTALLATION GUIDE

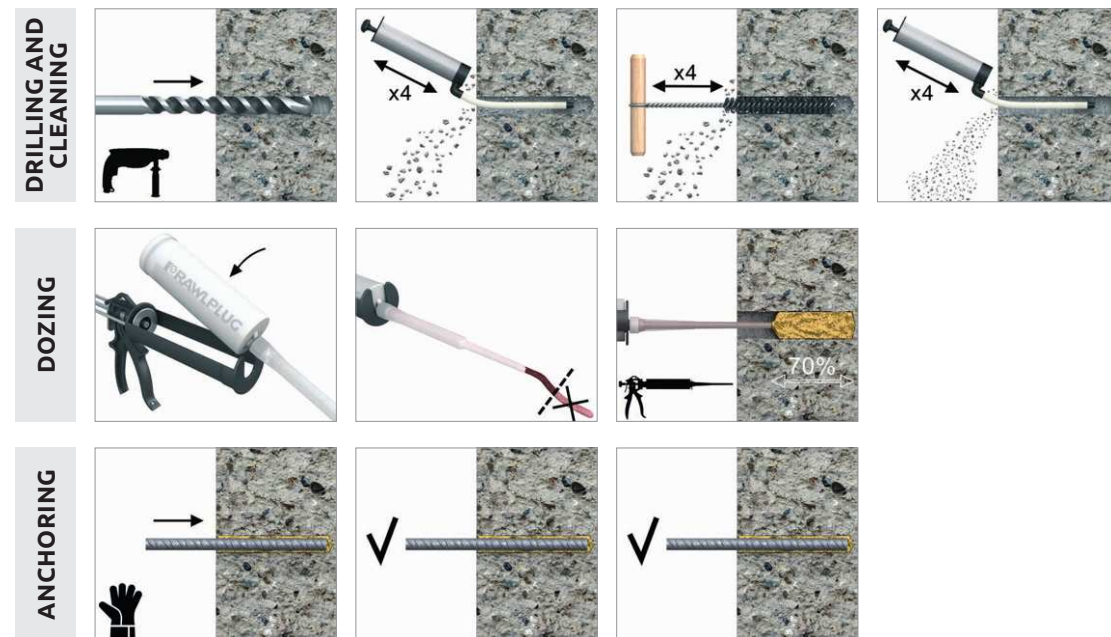

R-KEX-I EPOXY RESIN POST-INSTALLED REBARS

INSTALLATION GUIDE (cont.)

- Drill hole to the required diameter and depth for stud size being used.
- Clean the hole thoroughly with brush and hand pump at least four times before installation.
- Insert cartridge into gun and attach nozzle.
- Dispense to waste until even colour is obtained.
- Insert the mixing nozzle to the far end of the hole and inject resin, slowly withdrawing the nozzle as the hole is filled to 70% of its depth.
- Immediately insert the stud, slowly and with slight twisting motion. Remove any excess resin around the hole before it sets and leave it undisturbed until the curing time elapses.
- Attach fixture and tighten the nut to the required torque.

PRODUCT INFORMATION

Product Code	Resin	Description / Resin Type	Volume
			[ml]
R-KEX-I-600	R-KEX I	Epoxy Resin	600

INSTALLATION DATA

POST INSTALLED REBARS

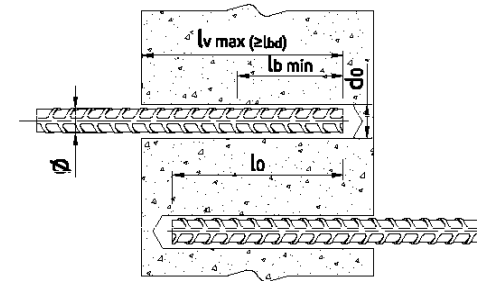

Size		Ø8	Ø10	Ø12	Ø13	Ø14	Ø16	Ø18	Ø20	Ø22	Ø25	Ø28	Ø30	Ø32	Ø34	Ø36	Ø40
Rebar diameter	d_s [mm]	8	10	12	13	14	16	18	20	22	25	28	30	32	34	36	40
Hole diameter in substrate	d_o [mm]	12	14	16	16	18	20	22	25	26	30	35	35	40	45	45	50
Brush diameter	- [mm]	14	16	18	18	20	22	24	27	27	32	37	37	42	47	47	52
Min. anchorage length	$l_{o,min}$ [mm]	115	145	170	185	200	230	260	285	315	355	400	420	455	485	510	570
Min. lap length (overlap splice)	$l_{o,min}$ [mm]	200	215	260	270	300	345	430	430	470	535	600	640	690	725	770	855
Max. anchorage length	$l_{v,max}$ [mm]	400	500	600	700	700	800	1000	1000	1100	1200	1400	1500	2500	2000	2000	2000

Minimum working and curing time

Resin temperature	Concrete temperature	Curing time*	Working time
[°C]	[°C]	[min]	[min]
5	5	2880	150
10	10	1080	120
20	20	480	35
25	30	300	12

*For wet concrete the curing time must be doubled

MECHANICAL PROPERTIES

POST INSTALLED REBARS

Size		Ø8	Ø10	Ø12	Ø13	Ø14	Ø16	Ø18	Ø20	Ø22	Ø25	Ø28	Ø30	Ø32	Ø34	Ø36	Ø40
$f_{yk} = 410$ (e.g. 34GS acc. to EC2)																	
Nominal yield strength - tension	F_{yk} [N/mm ²]	410	410	410	410	410	410	410	410	410	410	410	410	410	410	410	410
Cross sectional area - tension	A_s [mm ²]	53	79	113	133	154	201	255	314	380	491	616	707	804	908	1018	1257
$f_{yk} = 420$ (e.g. G-60 acc. to ASTM 615)																	
Nominal yield strength - tension	F_{yk} [N/mm ²]	420	420	420	420	420	420	420	420	420	420	420	420	420	420	420	420
Cross sectional area - tension	A_s [mm ²]	53	79	113	133	154	201	255	314	380	491	616	707	804	908	1018	1257
$f_{yk} = 460$ (e.g. 460 B acc. to BS 4449)																	
Nominal yield strength - tension	F_{yk} [N/mm ²]	460	460	460	460	460	460	460	460	460	460	460	460	460	460	460	460
Cross sectional area - tension	A_s [mm ²]	53	79	113	133	154	201	255	314	380	491	616	707	804	908	1018	1257
$f_{yk} = 500$ (e.g. B 500 SP acc. to EC2; 500 B acc. to BS 4449; B 500 B acc. to SS 560)																	
Nominal yield strength - tension	F_{yk} [N/mm ²]	500	500	500	500	500	500	500	500	500	500	500	500	500	500	500	500
Cross sectional area - tension	A_s [mm ²]	53	79	113	133	154	201	255	314	380	491	616	707	804	908	1018	1257
$f_{yk} = 600$ (e.g. B 600 B acc. to SS 560)																	
Nominal yield strength - tension	F_{yk} [N/mm ²]	600	600	600	600	600	600	600	600	600	600	600	600	600	600	600	600
Cross sectional area - tension	A_s [mm ²]	53	79	113	133	154	201	255	314	380	491	616	707	804	908	1018	1257

R-KEX-I EPOXY RESIN POST-INSTALLED REBARS

BASIC PERFORMANCE DATA

DESIGN RESISTANCE [kN] for l_{bd} [mm] – CONCRETE C20/25, NOMINAL YIELD STRENGTH FOR TENSION - $f_{yk} = 410$ [N/mm ²]																			
Size d_s [mm]	c_f/ϕ	100	150	200	250	300	400	500	600	700	800	900	1000	1250	1500	2000	2500	Loads $F_{Ed,yield}$ [kN]	Anchorage $l_{bd,yield}$ [mm]
8	a2=0,7	8,3	12,4	16,5	17,9	-	-	-	-	-	-	-	-	-	-	-	-	17,9	217,0
8	a2=1,0	5,8	8,7	11,6	14,5	17,3	17,9	-	-	-	-	-	-	-	-	-	-	17,9	310,0
10	a2=0,7	-	15,5	20,6	25,8	28,0	-	-	-	-	-	-	-	-	-	-	-	28,0	271,3
10	a2=1,0	-	10,8	14,5	18,1	21,7	28,0	-	-	-	-	-	-	-	-	-	-	28,0	387,5
12	a2=0,7	-	18,6	24,8	31,0	37,2	40,3	-	-	-	-	-	-	-	-	-	-	40,3	325,5
12	a2=1,0	-	13,0	17,3	21,7	26,0	34,7	40,3	-	-	-	-	-	-	-	-	-	40,3	465,0
13	a2=0,7	-	-	26,8	33,5	40,3	47,3	-	-	-	-	-	-	-	-	-	-	47,3	352,6
13	a2=1,0	-	-	18,8	23,5	28,2	37,6	47,0	47,3	-	-	-	-	-	-	-	-	47,3	503,8
14	a2=0,7	-	-	28,9	36,1	43,4	54,9	-	-	-	-	-	-	-	-	-	-	54,9	379,8
14	a2=1,0	-	-	20,2	25,3	30,3	40,5	50,6	54,9	-	-	-	-	-	-	-	-	54,9	542,5
16	a2=0,7	-	-	33,0	41,3	49,5	66,1	71,7	-	-	-	-	-	-	-	-	-	71,7	434,0
16	a2=1,0	-	-	23,1	28,9	34,7	46,2	57,8	69,4	71,7	-	-	-	-	-	-	-	71,7	620,0
18	a2=0,7	-	-	-	46,5	55,7	74,3	90,7	-	-	-	-	-	-	-	-	-	90,7	488,3
18	a2=1,0	-	-	-	32,5	39,0	52,0	65,0	78,0	90,7	-	-	-	-	-	-	-	90,7	697,5
20	a2=0,7	-	-	-	51,6	61,9	82,6	103,2	112,0	-	-	-	-	-	-	-	-	112,0	542,5
20	a2=1,0	-	-	-	36,1	43,4	57,8	72,3	86,7	101,2	112,0	-	-	-	-	-	-	112,0	775,0
22	a2=0,7	-	-	-	-	68,1	90,8	113,5	135,5	-	-	-	-	-	-	-	-	135,5	596,8
22	a2=1,0	-	-	-	-	47,7	63,6	79,5	95,4	111,3	127,2	135,5	-	-	-	-	-	135,5	852,6
25	a2=0,7	-	-	-	-	77,4	103,2	129,0	154,8	175,0	-	-	-	-	-	-	-	175,0	678,2
25	a2=1,0	-	-	-	-	54,2	72,3	90,3	108,4	126,4	144,5	162,6	175,0	-	-	-	-	175,0	968,8
28	a2=0,7	-	-	-	-	-	115,6	144,5	173,4	202,3	219,5	-	-	-	-	-	-	219,5	759,5
28	a2=1,0	-	-	-	-	-	80,9	101,2	121,4	141,6	161,9	182,1	202,3	219,5	-	-	-	219,5	1 085,1
30	a2=0,7	-	-	-	-	-	123,9	154,8	185,8	216,8	247,7	252,0	-	-	-	-	-	252,0	813,8
30	a2=1,0	-	-	-	-	-	86,7	108,4	130,1	151,7	173,4	195,1	216,8	252,0	-	-	-	252,0	1 162,6
32	a2=0,7	-	-	-	-	-	132,1	165,2	198,2	231,2	264,3	286,7	-	-	-	-	-	286,7	868,1
32	a2=1,0	-	-	-	-	-	92,5	115,6	138,7	161,9	185,0	208,1	231,2	286,7	-	-	-	286,7	1 240,1
34	a2=0,7	-	-	-	-	-	167,9	201,4	235,0	268,6	302,1	323,7	-	-	-	-	-	323,7	964,2
34	a2=1,0	-	-	-	-	-	117,5	141,0	164,5	188,0	211,5	235,0	293,7	323,7	-	-	-	323,7	1 377,5
36	a2=0,7	-	-	-	-	-	177,7	213,3	248,8	284,4	319,9	355,4	362,9	-	-	-	-	362,9	1 020,9
36	a2=1,0	-	-	-	-	-	124,4	149,3	174,2	199,1	223,9	248,8	311,0	362,9	-	-	-	362,9	1 458,5
40	a2=0,7	-	-	-	-	-	188,5	226,2	263,9	301,6	339,3	377,0	448,0	-	-	-	-	448,0	1 188,4
40	a2=1,0	-	-	-	-	-	131,9	158,3	184,7	211,1	237,5	263,9	329,9	395,8	448,0	-	-	448,0	1 697,7

DESIGN RESISTANCE [kN] for l_{bd} [mm] – CONCRETE C50/60, NOMINAL YIELD STRENGTH FOR TENSION - $f_{yk} = 410$ [N/mm ²]																			
Size d_s [mm]	c_f/ϕ	100	150	200	250	300	400	500	600	700	800	900	1000	1250	1500	2000	2500	Loads $F_{Ed,yield}$ [kN]	Anchorage $l_{bd,yield}$ [mm]
8	a2=0,7	15,4	17,9	-	-	-	-	-	-	-	-	-	-	-	-	-	-	17,9	116,1
8	a2=1,0	10,8	16,2	17,9	-	-	-	-	-	-	-	-	-	-	-	-	-	17,9	165,8
10	a2=0,7	19,3	28,0	-	-	-	-	-	-	-	-	-	-	-	-	-	-	28,0	145,1
10	a2=1,0	13,5	20,3	27,0	28,0	-	-	-	-	-	-	-	-	-	-	-	-	28,0	207,3
12	a2=0,7	-	34,7	40,3	-	-	-	-	-	-	-	-	-	-	-	-	-	40,3	174,1
12	a2=1,0	-	24,3	32,4	40,3	-	-	-	-	-	-	-	-	-	-	-	-	40,3	248,7
13	a2=0,7	-	37,6	47,3	-	-	-	-	-	-	-	-	-	-	-	-	-	47,3	188,6
13	a2=1,0	-	26,3	35,1	43,9	47,3	-	-	-	-	-	-	-	-	-	-	-	47,3	269,5
14	a2=0,7	-	40,5	54,0	54,9	-	-	-	-	-	-	-	-	-	-	-	-	54,9	203,1
14	a2=1,0	-	28,4	37,8	47,3	54,9	-	-	-	-	-	-	-	-	-	-	-	54,9	290,2
16	a2=0,7	-	-	61,8	71,7	-	-	-	-	-	-	-	-	-	-	-	-	71,7	232,2
16	a2=1,0	-	-	43,2	54,0	64,8	71,7	-	-	-	-	-	-	-	-	-	-	71,7	331,6
18	a2=0,7	-	-	69,5	86,8	90,7	-	-	-	-	-	-	-	-	-	-	-	90,7	261,2
18	a2=1,0	-	-	48,6	60,8	72,9	90,7	-	-	-	-	-	-	-	-	-	-	90,7	373,1
20	a2=0,7	-	-	71,8	89,8	107,7	112,0	-	-	-	-	-	-	-	-	-	-	112,0	312,0
20	a2=1,0	-	-	50,3	62,8	75,4	100,5	112,0	-	-	-	-	-	-	-	-	-	112,0	445,7
22	a2=0,7	-	-	-	98,7	118,5	135,5	-	-	-	-	-	-	-	-	-	-	135,5	343,2
22	a2=1,0	-	-	-	69,1	82,9	110,6	135,5	-	-	-	-	-	-	-	-	-	135,5	490,2
25	a2=0,7	-	-	-	103,8	124,5	166,1	175,0	-	-	-	-	-	-	-	-	-	175,0	421,6
25	a2=1,0	-	-	-	72,6	87,2	116,2	145,3	174,4	175,0	-	-	-	-	-	-	-	175,0	602,2
28	a2=0,7	-	-	-	-	128,2	170,9	213,6	219,5	-	-	-	-	-	-	-	-	219,5	513,8
28	a2=1,0	-	-	-	-	89,7	119,6	149,5	179,4	209,4	219,5	-	-	-	-	-	-	219,5	734,0
30	a2=0,7	-	-	-	-	137,3	183,1	228,9	252,0	-	-	-	-	-	-	-	-	252,0	550,5
30	a2=1,0	-	-	-	-	96,1	128,2	160,2	192,3	224,3	252,0	-	-	-	-	-	-	252,0	786,4
32	a2=0,7	-	-	-	-	-	195,3	244,1	286,7	-	-	-	-	-	-	-	-	286,7	587,2
32	a2=1,0	-	-	-	-	-	136,7	170,9	205,1	239,3	273,4	286,7	-	-	-	-	-	286,7	838,9
34	a2=0,7	-	-	-	-	-	177,0	221,3	265,5	309,8	323,7	-	-	-	-	-	-	323,7	731,5
34	a2=1,0	-	-	-	-	-	123,9	154,9	185,9	216,8	247,8	278,8	309,8	323,7	-	-	-	323,7	1 045,0
36	a2=0,7	-	-	-	-	-	187,4	234,3	281,1	328,0	362,9	-	-	-	-	-	-	362,9	774,5
36	a2=1,0	-	-	-	-	-	131,2	164,0	196,8	229,6	262,4	295,2	328,0	362,9	-	-	-	362,9	1 106,4
40	a2=0,7	-	-	-	-	-	188,5	226,2	263,9	301,6	339,3	377,0	448,0	-	-	-	-	448,0	1 188,4
40	a2=1,0	-	-	-	-	-	131,9	158,3	184,7	211,1	237,5	263,9	329,9	395,8	448,0	-	-	448,0	1 697,7

R-KEX-I EPOXY RESIN POST-INSTALLED REBARS

BASIC PERFORMANCE DATA (cont.)

DESIGN RESISTANCE [kN] for l_{bd} [mm] – CONCRETE C20/25, NOMINAL YIELD STRENGTH FOR TENSION - $f_{yk} = 420$ [N/mm ²]																			
Size d_s [mm]	c_f/ϕ	100	150	200	250	300	400	500	600	700	800	900	1000	1250	1500	2000	2500	Loads $F_{Ed,yield}$ [kN]	Anchorage $l_{bd,yield}$ [mm]
8	a2=0,7	8,3	12,4	16,5	18,4	-	-	-	-	-	-	-	-	-	-	-	-	18,4	222,3
8	a2=1,0	5,8	8,7	11,6	14,5	17,3	18,4	-	-	-	-	-	-	-	-	-	-	18,4	317,6
10	a2=0,7	-	15,5	20,6	25,8	28,7	-	-	-	-	-	-	-	-	-	-	-	28,7	277,9
10	a2=1,0	-	10,8	14,5	18,1	21,7	28,7	-	-	-	-	-	-	-	-	-	-	28,7	397,0
12	a2=0,7	-	18,6	24,8	31,0	37,2	41,3	-	-	-	-	-	-	-	-	-	-	41,3	333,5
12	a2=1,0	-	13,0	17,3	21,7	26,0	34,7	41,3	-	-	-	-	-	-	-	-	-	41,3	476,4
13	a2=0,7	-	-	26,8	33,5	40,3	48,5	-	-	-	-	-	-	-	-	-	-	48,5	361,2
13	a2=1,0	-	-	18,8	23,5	28,2	37,6	47,0	48,5	-	-	-	-	-	-	-	-	48,5	516,1
14	a2=0,7	-	-	28,9	36,1	43,4	56,2	-	-	-	-	-	-	-	-	-	-	56,2	389,0
14	a2=1,0	-	-	20,2	25,3	30,3	40,5	50,6	56,2	-	-	-	-	-	-	-	-	56,2	555,8
16	a2=0,7	-	-	33,0	41,3	49,5	66,1	73,4	-	-	-	-	-	-	-	-	-	73,4	444,6
16	a2=1,0	-	-	23,1	28,9	34,7	46,2	57,8	69,4	73,4	-	-	-	-	-	-	-	73,4	635,2

R-KEX-I EPOXY RESIN POST-INSTALLED REBARS

BASIC PERFORMANCE DATA (cont.)

DESIGN RESISTANCE [kN] for l_{bd} [mm] – CONCRETE C20/25, NOMINAL YIELD STRENGTH FOR TENSION - $f_{yk} = 460$ [N/mm ²]																			
Size d_s [mm]	c_f/\emptyset	100	150	200	250	300	400	500	600	700	800	900	1000	1250	1500	2000	2500	Loads $F_{Ed,yield}$ [kN]	Anchorage $l_{bd,yield}$ [mm]
8	a2=0,7	-	12,4	16,5	20,1	-	-	-	-	-	-	-	-	-	-	-	-	20,1	243,5
8	a2=1,0	-	8,7	11,6	14,5	17,3	20,1	-	-	-	-	-	-	-	-	-	-	20,1	347,8
10	a2=0,7	-	15,5	20,6	25,8	31,0	31,4	-	-	-	-	-	-	-	-	-	-	31,4	304,3
10	a2=1,0	-	10,8	14,5	18,1	21,7	28,9	31,4	-	-	-	-	-	-	-	-	-	31,4	434,8
12	a2=0,7	-	-	24,8	31,0	37,2	45,2	-	-	-	-	-	-	-	-	-	-	45,2	365,2
12	a2=1,0	-	-	17,3	21,7	26,0	34,7	43,4	45,2	-	-	-	-	-	-	-	-	45,2	521,7
13	a2=0,7	-	-	26,8	33,5	40,3	53,1	-	-	-	-	-	-	-	-	-	-	53,1	395,7
13	a2=1,0	-	-	18,8	23,5	28,2	37,6	47,0	53,1	-	-	-	-	-	-	-	-	53,1	565,2
14	a2=0,7	-	-	28,9	36,1	43,4	57,8	61,6	-	-	-	-	-	-	-	-	-	61,6	426,1
14	a2=1,0	-	-	20,2	25,3	30,3	40,5	50,6	60,7	61,6	-	-	-	-	-	-	-	61,6	608,7
16	a2=0,7	-	-	-	41,3	49,5	66,1	80,4	-	-	-	-	-	-	-	-	-	80,4	487,0
16	a2=1,0	-	-	-	28,9	34,7	46,2	57,8	69,4	80,4	-	-	-	-	-	-	-	80,4	695,7
18	a2=0,7	-	-	-	46,5	55,7	74,3	92,9	101,8	-	-	-	-	-	-	-	-	101,8	547,8
18	a2=1,0	-	-	-	32,5	39,0	52,0	65,0	78,0	91,0	101,8	-	-	-	-	-	-	101,8	782,6
20	a2=0,7	-	-	-	-	61,9	82,6	103,2	123,9	125,7	-	-	-	-	-	-	-	125,7	608,7
20	a2=1,0	-	-	-	-	43,4	57,8	72,3	86,7	101,2	115,6	125,7	-	-	-	-	-	125,7	869,6
22	a2=0,7	-	-	-	-	68,1	90,8	113,5	136,3	152,1	-	-	-	-	-	-	-	152,1	669,6
22	a2=1,0	-	-	-	-	47,7	63,6	79,5	95,4	111,3	127,2	143,1	152,1	-	-	-	-	152,1	956,5
25	a2=0,7	-	-	-	-	103,2	129,0	154,8	180,6	196,4	-	-	-	-	-	-	-	196,4	760,9
25	a2=1,0	-	-	-	-	72,3	90,3	108,4	126,4	144,5	162,6	180,6	-	-	-	-	-	196,4	1087,0
28	a2=0,7	-	-	-	-	115,6	144,5	173,4	202,3	231,2	246,3	-	-	-	-	-	-	246,3	852,2
28	a2=1,0	-	-	-	-	80,9	101,2	121,4	141,6	161,9	182,1	202,3	246,3	-	-	-	-	246,3	1217,4
30	a2=0,7	-	-	-	-	123,9	154,8	185,8	216,8	247,7	278,7	282,7	-	-	-	-	-	282,7	913,0
30	a2=1,0	-	-	-	-	86,7	108,4	130,1	151,7	173,4	195,1	216,8	271,0	282,7	-	-	-	282,7	1304,3
32	a2=0,7	-	-	-	-	-	165,2	198,2	231,2	264,3	297,3	321,7	-	-	-	-	-	321,7	973,9
32	a2=1,0	-	-	-	-	-	115,6	138,7	161,9	185,0	208,1	231,2	289,0	321,7	-	-	-	321,7	1391,3
34	a2=0,7	-	-	-	-	-	167,9	201,4	235,0	268,6	302,1	335,7	363,2	-	-	-	-	363,2	1081,8
34	a2=1,0	-	-	-	-	-	117,5	141,0	164,5	188,0	211,5	235,0	293,7	352,5	363,2	-	-	363,2	1545,5
36	a2=0,7	-	-	-	-	-	177,7	213,3	248,8	284,4	319,9	355,4	407,2	-	-	-	-	407,2	1145,5
36	a2=1,0	-	-	-	-	-	124,4	149,3	174,2	199,1	223,9	248,8	311,0	373,2	407,2	-	-	407,2	1636,4
40	a2=0,7	-	-	-	-	-	226,2	263,9	301,6	339,3	377,0	471,2	502,6	-	-	-	-	502,6	1333,3
40	a2=1,0	-	-	-	-	-	158,3	184,7	211,1	237,5	263,9	329,9	395,8	502,6	-	-	-	502,6	1904,8

DESIGN RESISTANCE [kN] for l_{bd} [mm] – CONCRETE C50/60, NOMINAL YIELD STRENGTH FOR TENSION - $f_{yk} = 460$ [N/mm ²]																			
Size d_s [mm]	c_f/\emptyset	100	150	200	250	300	400	500	600	700	800	900	1000	1250	1500	2000	2500	Loads $F_{Ed,yield}$ [kN]	Anchorage $l_{bd,yield}$ [mm]
8	a2=0,7	15,4	20,1	-	-	-	-	-	-	-	-	-	-	-	-	-	-	20,1	130,2
8	a2=1,0	10,8	16,2	20,1	-	-	-	-	-	-	-	-	-	-	-	-	-	20,1	186,0
10	a2=0,7	19,3	28,9	31,4	-	-	-	-	-	-	-	-	-	-	-	-	-	31,4	162,8
10	a2=1,0	13,5	20,3	27,0	31,4	-	-	-	-	-	-	-	-	-	-	-	-	31,4	232,6
12	a2=0,7	-	34,7	45,2	-	-	-	-	-	-	-	-	-	-	-	-	-	45,2	195,3
12	a2=1,0	-	24,3	32,4	40,5	45,2	-	-	-	-	-	-	-	-	-	-	-	45,2	279,1
13	a2=0,7	-	37,6	50,2	53,1	-	-	-	-	-	-	-	-	-	-	-	-	53,1	211,6
13	a2=1,0	-	26,3	35,1	43,9	52,7	53,1	-	-	-	-	-	-	-	-	-	-	53,1	302,3
14	a2=0,7	-	40,5	54,0	61,6	-	-	-	-	-	-	-	-	-	-	-	-	61,6	227,9
14	a2=1,0	-	28,4	37,8	47,3	56,7	61,6	-	-	-	-	-	-	-	-	-	-	61,6	325,6
16	a2=0,7	-	-	61,8	77,2	80,4	-	-	-	-	-	-	-	-	-	-	-	80,4	260,5
16	a2=1,0	-	-	43,2	54,0	64,8	80,4	-	-	-	-	-	-	-	-	-	-	80,4	372,1
18	a2=0,7	-	-	69,5	86,8	101,8	-	-	-	-	-	-	-	-	-	-	-	101,8	293,0
18	a2=1,0	-	-	48,6	60,8	72,9	97,3	101,8	-	-	-	-	-	-	-	-	-	101,8	418,6
20	a2=0,7	-	-	71,8	89,8	107,7	125,7	-	-	-	-	-	-	-	-	-	-	125,7	350,0
20	a2=1,0	-	-	50,3	62,8	75,4	100,5	125,7	125,7	-	-	-	-	-	-	-	-	125,7	500,0
22	a2=0,7	-	-	-	98,7	118,5	152,1	-	-	-	-	-	-	-	-	-	-	152,1	385,0
22	a2=1,0	-	-	-	69,1	82,9	110,6	138,2	152,1	-	-	-	-	-	-	-	-	152,1	550,0
25	a2=0,7	-	-	-	103,8	124,5	166,1	196,4	-	-	-	-	-	-	-	-	-	196,4	473,0
25	a2=1,0	-	-	-	72,6	87,2	116,2	145,3	174,4	196,4	-	-	-	-	-	-	-	196,4	675,7
28	a2=0,7	-	-	-	-	128,2	170,9	213,6	246,3	-	-	-	-	-	-	-	-	246,3	576,5
28	a2=1,0	-	-	-	-	89,7	119,6	149,5	179,4	209,4	239,3	246,3	-	-	-	-	-	246,3	823,5
30	a2=0,7	-	-	-	-	137,3	183,1	228,9	274,7	282,7	-	-	-	-	-	-	-	282,7	617,6
30	a2=1,0	-	-	-	-	96,1	128,2	160,2	192,3	224,3	256,4	282,7	-	-	-	-	-	282,7	882,4
32	a2=0,7	-	-	-	-	195,3	244,1	293,0	321,7	-	-	-	-	-	-	-	-	321,7	658,8
32	a2=1,0	-	-	-	-	136,7	170,9	205,1	239,3	273,4	307,6	321,7	-	-	-	-	-	321,7	941,2
34	a2=0,7	-	-	-	-	177,0	221,3	265,5	309,8	354,0	363,2	-	-	-	-	-	-	363,2	820,7
34	a2=1,0	-	-	-	-	123,9	154,9	185,9	216,8	247,8	278,8	309,8	363,2	-	-	-	-	363,2	1172,4
36	a2=0,7	-	-	-	-	187,4	234,3	281,1	328,0	374,8	407,2	-	-	-	-	-	-	407,2	869,0
36	a2=1,0	-	-	-	-	131,2	164,0	196,8	229,6	262,4	295,2	328,0	407,2	-	-	-	-	407,2	1241,4
40	a2=0,7	-	-	-	-	-	226,2	263,9	301,6	339,3	377,0	471,2	502,6	-	-	-	-	502,6	1333,3
40	a2=1,0	-	-	-	-	-	158,3	184,7	211,1	237,5	263,9	329,9	395,8	502,6	-	-	-	502,6	1904,8

R-KEX-I EPOXY RESIN POST-INSTALLED REBARS

BASIC PERFORMANCE DATA (cont.)

DESIGN RESISTANCE [kN] for l_{bd} [mm] – CONCRETE C20/25, NOMINAL YIELD STRENGTH FOR TENSION - $f_{yk} = 500$ [N/mm ²]																			
Size d_s [mm]	c_f/\emptyset	100	150	200	250	300	400	500	600	700	800	900	1000	1250	1500	2000	2500	Loads $F_{Ed,yield}$ [kN]	Anchorage $l_{bd,yield}$ [mm]
8	a2=0,7	-	12,4	16,5	20,6	21,9	-	-	-	-	-	-	-	-	-	-	-	21,9	264,7
8	a2=1,0	-	8,7	11,6	14,5	17,3	21,9	-	-	-	-	-	-	-	-	-	-	21,9	378,1
10	a2=0,7	-	15,5	20,6	25,8	31,0	34,1	-	-	-	-	-	-	-	-	-	-	34,1	330,8
10	a2=1,0	-	10,8	14,5	18,1	21,7	28,9	34,1	-	-	-	-	-	-	-	-	-	34,1	472,6
12	a2=0,7	-	-	24,8	31,0	37,2	49,2	-	-	-	-	-	-	-	-	-	-	49,2	397,0
12	a2=1,0	-	-	17,3	21,7	26,0	34,7	43,4	49,2	-	-	-	-	-	-	-	-	49,2	567,1
13	a2=0,7	-	-	26,8	33,5	40,3	53,7	-	-	-	-	-	-	-	-	-	-	53,7	430,1
13	a2=1,0	-	-	18,8	23,5	28,2	37,6	47,0	56,4	57,7	-	-	-	-	-	-	-	57,7	614,4
14	a2=0,7	-	-	28,9	36,1	43,4	57,8	66,9	-	-	-	-	-	-	-	-	-	66,9	463,1
14	a2=1,0	-	-	20,2	25,3	30,3	40,5	50,6	60,7	66,9	-	-	-	-	-	-	-	66,9	661,6
16	a2=0,7	-	-	-	41,3	49,5	66,1	82,6	87,4	-	-	-	-	-	-	-	-	87,4	529,3
16	a2=1,0																		

R-KER-II-S | R-CFS+KER-II-S WITH POST-INSTALLED REBAR

High performance hybrid resin approved for use with post-installed rebar connections



FEATURES AND BENEFITS

- Approved for 3 types of hole cleaning (including use of dustless drill bit)
- Approved for use with post-installed rebars in concrete (EAD 330087-00-0601)
- Very high load capacity
- Suitable for use in dry or wet substrates and water filled holes
- Rapid bonding time enables quick execution of works

APPLICATIONS

- Post-installed rebar connections
- Rebar
- Rebar missed-outs
- Extending existing buildings and structures
- Renovation and modernization of bridges, buildings
- Platforms
- Safety barriers
- Barriers

BASE MATERIALS

- Approved for use in:
 - Concrete C12/15-C50/60

INSTALLATION GUIDE

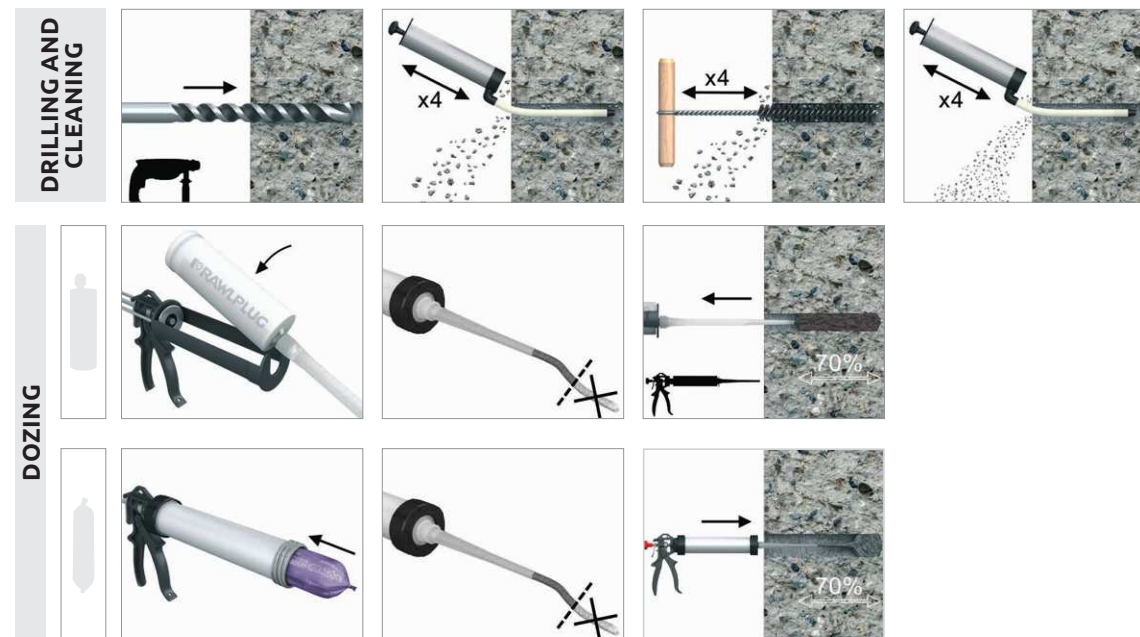

R-KER-II-S | R-CFS+KER-II-S WITH POST-INSTALLED REBAR

INSTALLATION GUIDE (cont.)

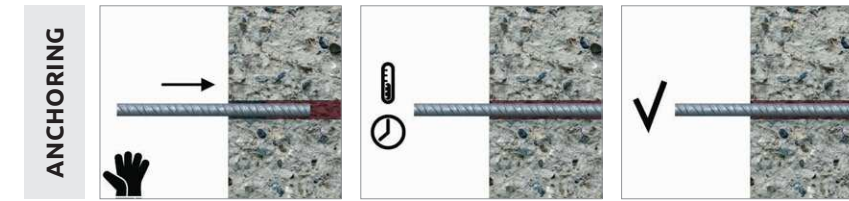

- Drill hole to the required diameter and depth for rebar size being used.
- Clean the drill hole thoroughly with brush and hand pump at least four times before installation
- Insert cartridge into gun and attach nozzle.
- Dispense to waste until even colour is obtained (min. 10 cm)
- Insert the mixer nozzle to the bottom of the drill hole and inject resin, slowly withdrawing the nozzle as the hole is filled to 70% of its depth.
- Immediately insert the rebar, slowly and with slight twisting motion. Remove any excess resin around the hole before it sets and leave it undisturbed until the curing time elapses.

PRODUCT INFORMATION

	Product Code	Resin	Description / Resin Type	Volume
				[ml]
[Icon]	R-KER-II-300-S	R-KER-II-S	R-KER II Hybrid Resin for High Temperature (Summer) / Slow Cure Styrene Free Hybrid Resin	300
	R-KER-II-400-S			400
[Icon]	R-CFS+KERII-300-S	R-CFS+KERII-S	R-KER II Hybrid Resin for High Temperature (Summer) / Slow Cure Styrene Free Hybrid Resin	300
	R-CFS+KERII-600-S			600

INSTALLATION DATA

POST INSTALLED REBARS

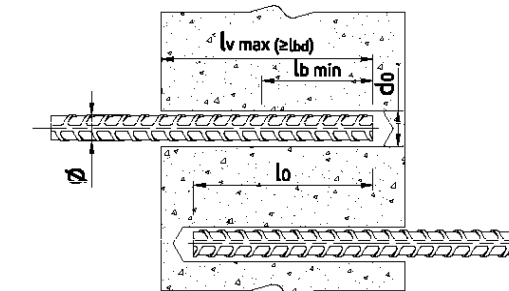

Size			Ø8	Ø10	Ø12	Ø14	Ø16	Ø20	Ø25	Ø28	Ø32	Ø40
Rebar diameter	d_s	[mm]	8	10	12	14	16	20	25	28	32	40
Hole diameter in substrate	d_0	[mm]	12	14	16	18	20	25	30	35	40	50
Brush diameter	-	[mm]	14	16	18	20	22	27	32	37	42	52
Min. anchorage length	$l_{b, min}$	[mm]	115	145	170	200	230	285	355	400	455	570
Min. lap length (overlap splice)	$l_{0, min}$	[mm]	200	215	255	300	340	430	540	600	690	860
Max. anchorage length	$l_{v, max}$	[mm]	400	500	600	700	800	1000	1200	1400	1500	1000

Minimum working and curing time

Resin temperature	Concrete temperature	Curing time*	Working time
°C	°C	[min]	[min]
5	5	12h	40
10	10	8h	20
15	15	6h	15
20	20	4h	10
25	25	3h	9.5
25	30	2h	7
25	35	2h	6.5
25	40	1.5h	6.5

*For wet concrete the curing time must be doubled

R-KER-II-S | R-CFS+KER-II-S WITH POST-INSTALLED REBAR

BASIC PERFORMANCE DATA (cont.)

DESIGN RESISTANCE [kN] for l_{bd} [mm] – CONCRETE C50/60, NOMINAL YIELD STRENGTH FOR TENSION - $f_{yk} = 460$ [N/mm ²]																			
Size d_s [mm]	c_f/ϕ	100	150	200	250	300	400	500	600	700	800	900	1000	1250	1500	2000	2500	Loads $F_{Ed,yield}$ [kN]	Anchorage $l_{bd,yield}$ [mm]
8	a2=0,7	15,4	20,1	-	-	-	-	-	-	-	-	-	-	-	-	-	-	20,1	130,2
8	a2=1,0	10,8	16,2	20,1	-	-	-	-	-	-	-	-	-	-	-	-	-	20,1	186,0
10	a2=0,7	19,3	28,9	31,4	-	-	-	-	-	-	-	-	-	-	-	-	-	31,4	162,8
10	a2=1,0	13,5	20,3	27,0	31,4	-	-	-	-	-	-	-	-	-	-	-	-	31,4	232,6
12	a2=0,7	-	32,3	43,1	45,2	-	-	-	-	-	-	-	-	-	-	-	-	45,2	210,0
12	a2=1,0	-	22,6	30,2	37,7	45,2	45,2	-	-	-	-	-	-	-	-	-	-	45,2	300,0
14	a2=0,7	-	37,7	50,3	61,6	-	-	-	-	-	-	-	-	-	-	-	-	61,6	245,0
14	a2=1,0	-	26,4	35,2	44,0	52,8	61,6	-	-	-	-	-	-	-	-	-	-	61,6	350,0
16	a2=0,7	-	-	53,1	66,4	79,7	80,4	-	-	-	-	-	-	-	-	-	-	80,4	302,7
16	a2=1,0	-	-	37,2	46,5	55,8	74,4	80,4	-	-	-	-	-	-	-	-	-	80,4	432,4
20	a2=0,7	-	-	66,4	83,0	99,6	125,7	-	-	-	-	-	-	-	-	-	-	125,7	378,4
20	a2=1,0	-	-	46,5	58,1	69,7	93,0	116,2	125,7	-	-	-	-	-	-	-	-	125,7	540,5
25	a2=0,7	-	-	-	95,4	114,4	152,6	190,7	196,4	-	-	-	-	-	-	-	-	196,4	514,7
25	a2=1,0	-	-	-	66,8	80,1	106,8	133,5	160,2	186,9	196,4	-	-	-	-	-	-	196,4	735,3
28	a2=0,7	-	-	-	-	-	128,2	170,9	213,6	246,3	-	-	-	-	-	-	-	246,3	576,5
28	a2=1,0	-	-	-	-	89,7	119,6	149,5	179,4	209,4	239,3	246,3	-	-	-	-	-	246,3	823,5
32	a2=0,7	-	-	-	-	-	172,3	215,4	258,5	301,6	321,7	-	-	-	-	-	-	321,7	746,7
32	a2=1,0	-	-	-	-	-	120,6	150,8	181,0	211,1	241,3	271,4	301,6	321,7	-	-	-	321,7	1066,7
40	a2=0,7	-	-	-	-	-	-	206,4	247,7	289,0	330,3	371,6	412,9	-	-	-	-	502,6	1217,4
40	a2=1,0	-	-	-	-	-	-	144,5	173,4	202,3	231,2	260,1	289,0	-	-	-	-	502,6	1739,1

DESIGN RESISTANCE [kN] for l_{bd} [mm] – CONCRETE C20/25, NOMINAL YIELD STRENGTH FOR TENSION - $f_{yk} = 500$ [N/mm ²]																			
Size d_s [mm]	c_f/ϕ	100	150	200	250	300	400	500	600	700	800	900	1000	1250	1500	2000	2500	Loads $F_{Ed,yield}$ [kN]	Anchorage $l_{bd,yield}$ [mm]
8	a2=0,7	-	12,4	16,5	20,6	21,9	-	-	-	-	-	-	-	-	-	-	-	21,9	264,7
8	a2=1,0	-	8,7	11,6	14,5	17,3	21,9	-	-	-	-	-	-	-	-	-	-	21,9	378,1
10	a2=0,7	-	15,5	20,6	25,8	31,0	34,1	-	-	-	-	-	-	-	-	-	-	34,1	330,8
10	a2=1,0	-	10,8	14,5	18,1	21,7	28,9	34,1	-	-	-	-	-	-	-	-	-	34,1	472,6
12	a2=0,7	-	-	24,8	31,0	37,2	49,2	-	-	-	-	-	-	-	-	-	-	49,2	397,0
12	a2=1,0	-	-	17,3	21,7	26,0	34,7	43,4	49,2	-	-	-	-	-	-	-	-	49,2	567,1
14	a2=0,7	-	-	28,9	36,1	43,4	57,8	66,9	-	-	-	-	-	-	-	-	-	66,9	463,1
14	a2=1,0	-	-	20,2	25,3	30,3	40,5	50,6	60,7	66,9	-	-	-	-	-	-	-	66,9	661,6
16	a2=0,7	-	-	-	41,3	49,5	66,1	82,6	87,4	-	-	-	-	-	-	-	-	87,4	529,3
16	a2=1,0	-	-	-	28,9	34,7	46,2	57,8	69,4	80,9	87,4	-	-	-	-	-	-	87,4	756,1
20	a2=0,7	-	-	-	-	61,9	82,6	103,2	123,9	136,6	-	-	-	-	-	-	-	136,6	661,6
20	a2=1,0	-	-	-	-	43,4	57,8	72,3	86,7	101,2	115,6	130,1	136,6	-	-	-	-	136,6	945,2
25	a2=0,7	-	-	-	-	-	103,2	129,0	154,8	180,6	206,4	213,4	-	-	-	-	-	213,4	827,0
25	a2=1,0	-	-	-	-	-	72,3	90,3	108,4	126,4	144,5	162,6	180,6	198,7	213,4	-	-	213,4	1181,5
28	a2=0,7	-	-	-	-	-	115,6	144,5	173,4	202,3	231,2	260,1	267,7	-	-	-	-	267,7	926,3
28	a2=1,0	-	-	-	-	-	80,9	101,2	121,4	141,6	161,9	182,1	202,3	222,6	242,8	263,0	-	267,7	1323,3
32	a2=0,7	-	-	-	-	-	-	165,2	198,2	231,2	264,3	297,3	330,3	349,7	-	-	-	349,7	1058,6
32	a2=1,0	-	-	-	-	-	-	115,6	138,7	161,9	185,0	208,1	231,2	254,3	277,5	300,6	346,8	349,7	1512,3
40	a2=0,7	-	-	-	-	-	-	-	215,4	251,3	287,2	323,1	359,0	-	-	-	-	546,3	1521,7
40	a2=1,0	-	-	-	-	-	-	-	150,8	175,9	201,1	226,2	251,3	-	-	-	-	546,3	2173,9

DESIGN RESISTANCE [kN] for l_{bd} [mm] – CONCRETE C50/60, NOMINAL YIELD STRENGTH FOR TENSION - $f_{yk} = 500$ [N/mm ²]																			
Size d_s [mm]	c_f/ϕ	100	150	200	250	300	400	500	600	700	800	900	1000	1250	1500	2000	2500	Loads $F_{Ed,yield}$ [kN]	Anchorage $l_{bd,yield}$ [mm]
8	a2=0,7	15,4	21,9	-	-	-	-	-	-	-	-	-	-	-	-	-	-	21,9	141,6
8	a2=1,0	10,8	16,2	21,6	21,9	-	-	-	-	-	-	-	-	-	-	-	-	21,9	202,2
10	a2=0,7	19,3	28,9	34,1	-	-	-	-	-	-	-	-	-	-	-	-	-	34,1	176,9
10	a2=1,0	13,5	20,3	27,0	33,8	34,1	-	-	-	-	-	-	-	-	-	-	-	34,1	252,8
12	a2=0,7	-	32,3	43,1	49,2	-	-	-	-	-	-	-	-	-	-	-	-	49,2	228,3
12	a2=1,0	-	22,6	30,2	37,7	45,2	49,2	-	-	-	-	-	-	-	-	-	-	49,2	326,1
14	a2=0,7	-	37,7	50,3	62,8	66,9	-	-	-	-	-	-	-	-	-	-	-	66,9	266,3
14	a2=1,0	-	26,4	35,2	44,0	52,8	66,9	-	-	-	-	-	-	-	-	-	-	66,9	380,4
16	a2=0,7	-	-	53,1	66,4	79,7	87,4	-	-	-	-	-	-	-	-	-	-	87,4	329,0
16	a2=1,0	-	-	37,2	46,5	55,8	74,4	87,4	-	-	-	-	-	-	-	-	-	87,4	470,0
20	a2=0,7	-	-	66,4	83,0	99,6	132,8	136,6	-	-	-	-	-	-	-	-	-	136,6	411,3
20	a2=1,0	-	-	46,5	58,1	69,7	93,0	116,2	136,6	-	-	-	-	-	-	-	-	136,6	587,5
25	a2=0,7	-	-	-	95,4	114,4	152,6	190,7	213,4	-	-	-	-	-	-	-	-	213,4	559,5
25	a2=1,0	-	-	-	66,8	80,1	106,8	133,5	160,2	186,9	213,4	-	-	-	-	-	-	213,4	799,2
28	a2=0,7	-	-	-	-	-	128,2	170,9	213,6	256,4	267,7	-	-	-	-	-	-	267,7	626,6
28	a2=1,0	-	-	-	-	89,7	119,6	149,5	179,4	209,4	239,3	267,7	-	-	-	-	-	267,7	895,1
32	a2=0,7	-	-	-	-	-	172,3	215,4	258,5	301,6	344,7	349,7	-	-	-	-	-	349,7	811,6
32	a2=1,0	-	-	-	-	-	120,6	150,8	181,0	211,1	241,3	271,4	301,6	331,8	349,7	-	-	349,7	1159,4
40	a2=0,7	-	-	-	-	-	-	247,7	289,0	330,3	371,6	412,9	-	-	-	-	-	546,3	1323,3
40	a2=1,0	-	-	-	-	-	-	173,4	202,3	231,2	260,1	289,0	-	-	-	-	-	546,3	1890,4

R-KER-II-S | R-CFS+KER-II-S WITH POST-INSTALLED REBAR

BASIC PERFORMANCE DATA (cont.)

DESIGN RESISTANCE [kN] for l_{bd} [mm] – CONCRETE C20/25, NOMINAL YIELD STRENGTH FOR TENSION - $f_{yk} = 600$ [N/mm ²]																			
Size d_s [mm]	c_f/ϕ	100	150	200	250	300	400	500	600	700	800	900	1000	1250	1500	2000	2500	Loads $F_{Ed,yield}$ [kN]	Anchorage $l_{bd,yield}$ [mm]
8	a2=0,7	-	12,4	16,5	20,6	24,8	26,2	-	-	-	-	-	-	-	-	-	-	26,2	317,6
8	a2=1,0	-	8,7	11,6	14,5	17,3	23,1	-	-	-	-	-	-	-	-	-	-	26,2	453,7
10	a2=0,7	-	-	20,6	25,8	31,0	41,0	-	-	-	-	-	-	-	-	-	-	41,0	397,0
10	a2=1,0	-	-	14,5	18,1	21,7	28,9	36,1	-	-	-	-	-	-	-	-	-	41,0	567,1
12	a2=0,7	-	-	-	31,0	37,2	49,5	59,0	-	-	-	-	-	-	-	-	-	59,0	476,4
12	a2=1,0	-	-	-	21,7	26,0	34,7	43,4	52,0	-	-	-	-	-	-	-	-	59,0	680,5
14	a2=0,7	-	-	-	36,1	43,4	57,8	72,3	80,3	-	-	-	-	-	-	-	-	80,3	555,8
14	a2=1,0	-	-	-	25,3	30,3	40,5	50,6	60,7	70,8	-	-	-	-	-	-	-	80,3	794,0
16	a2=0,7	-	-	-	49,5	66,1	82,6	99,1	104,9	-	-	-	-	-	-	-	-	104,9	635,2
16	a2=1,0	-	-	-	34,7	46,2	57,8	69,4	80,9	92,5	-	-	-	-	-	-	-	104,9	907,4
20	a2=0,7	-	-	-	-	82,6	103,2	123,9	144,5	163,9	-	-	-	-	-	-	-	163,9	794,0
20	a2=1,0	-	-	-	-	57,8	72,3	86,7	101,2	115,6	130,1	144,5	-	-	-	-	-	163,9	1134,2
25	a2=0,7	-	-	-	-	-	129,0	154,8	180,6	206,4	232,3	256,1	-	-	-	-	-	256,1	992,4
25	a2=1,0	-	-	-	-	-	9												

R-KER-II-S | R-CFS+KER-II-S WITH POST-INSTALLED REBAR

DESIGN PERFORMANCE DATA

POST INSTALLED REBARS

Size	TENSION LOAD											
	Ø8	Ø10	Ø12	Ø14	Ø16	Ø20	Ø25	Ø28	Ø32	Ø40		
Mean ultimate bond resistance C12/15	F_{bd}	[N/mm ²]	1.60	1.60	1.60	1.60	1.60	1.60	1.60	1.60	1.60	1.60
Mean ultimate bond resistance C16/20	F_{bd}	[N/mm ²]	2.00	2.00	2.00	2.00	2.00	2.00	2.00	2.00	2.00	2.00
Mean ultimate bond resistance C20/25	F_{bd}	[N/mm ²]	2.30	2.30	2.30	2.30	2.30	2.30	2.30	2.30	2.30	2.00
Mean ultimate bond resistance C25/30	F_{bd}	[N/mm ²]	2.70	2.70	2.70	2.70	2.70	2.70	2.70	2.70	2.70	2.00
Mean ultimate bond resistance C30/37	F_{bd}	[N/mm ²]	3.00	3.00	3.00	3.00	3.00	3.00	3.00	3.00	2.70	2.00
Mean ultimate bond resistance C35/45	F_{bd}	[N/mm ²]	3.40	3.40	3.40	3.40	3.40	3.40	3.00	3.00	3.00	2.00
Mean ultimate bond resistance C40/50	F_{bd}	[N/mm ²]	3.70	3.70	3.70	3.70	3.70	3.40	3.00	3.00	3.00	2.30
Mean ultimate bond resistance C45/55	F_{bd}	[N/mm ²]	4.00	4.00	4.00	3.70	3.70	3.40	3.40	3.00	3.00	2.30
Mean ultimate bond resistance C50/60	F_{bd}	[N/mm ²]	4.30	4.30	4.00	4.00	3.70	3.70	3.40	3.00	3.00	2.30

R-KEM-II | RM50 WITH THREADED RODS FOR MASONRY

Universal polyester (styrene free) resin - European Approval for 15 substrates



FEATURES AND BENEFITS

- The most convenient bonded anchor for general purpose use
- Approved for 15 substrates
- Quick, secure and simple installation
- Product with wide spectrum of use in the medium load capacity area
- Ideal for applications where mechanical anchors are not suitable
- Easy dosage thanks to patented self-opening system and use of manual or pneumatic gun
- Option of use standard manual silicone gun
- Suitable for multiple use. Partly used product can be reused after fitting new nozzle

APPLICATIONS

- Gates
- Window elements
- Canopies
- Sanitary appliances
- Railings
- Handrails
- Consoles
- Ladders
- Cable trays

BASE MATERIALS

- Approved for use in:
- Hollow Brick
 - Solid Brick
 - Hollow Sand-lime Brick
 - Solid Sand-lime Brick
 - Hollow Lightweight Concrete Block
 - Aerated Concrete Block
- Also applicable to:
- Hollow-core Slab

INSTALLATION GUIDE



R-KEM-II | RM50 WITH THREADED RODS FOR MASONRY

INSTALLATION GUIDE (cont.)

1. Drill hole to the required diameter and depth for stud size being used.
2. Solid substrates: Clean the drill hole thoroughly with brush and hand pump at least four times before installation.
3. Hollow substrates: insert mesh sleeve into the hole.
4. Insert cartridge into gun and attach nozzle.
5. Dispense to waste until even colour is obtained.
6. Solid substrates: Insert the mixer nozzle to the bottom of the drill hole and inject resin, slowly withdrawing the nozzle as the hole is filled to 70% of its depth.
7. Hollow substrates: Insert the mixer nozzle to the bottom of the drill hole and inject resin, slowly withdrawing the nozzle as the hole is filled to 100% of its depth.
8. Immediately insert the stud, slowly and with slight twisting motion. Remove any excess resin around the hole before it sets and leave it undisturbed until the curing time elapses.
9. Attach fixture and tighten the nut to the required torque.

PRODUCT INFORMATION

Product Code	Resin	Description / Resin Type	Volume
			[ml]
R-KEM-II-175	R-KEMII	Styrene Free Polyester Resin	175
R-KEM-II-300			300
R-KEM-II-410			410
R-KEM-II-175-W	R-KEMII-W	Low Temperature (Winter) / Rapid Cure Styrene Free Polyester Resin	175
R-KEM-II-300-W			300
R-KEM-II-175-S	R-KEMII-S	High Temperature (Summer) / Slow Cure Styrene Free Polyester Resin	175
R-KEM-II-300-S			300
R-KEM-II-175-SET			175
R-KEM-II-300-SET	Set with 4 studs and plastic sleeves		300
R-KEM-II-300-STONE	R-KEMII	Stone colour Styrene Free Polyester Resin	300
R-KEM-II-410-STONE			410
R-KEM-II-300-GREY			300
R-KEM-II-410-GREY			410
R-KEM-II-300-SV			300
R-CFS+RM50-4	RM50	Styrene Free Polyester Resin	300
R-CFS+RM50-600-8	RM50	Styrene Free Polyester Resin	600

R-STUDS

Size	Product Code			Anchor		Fixture
	Steel class 5.8	Steel class 8.8	Steel grade A4	Diameter	Length	Hole diameter
				d	L	d _f
				[mm]	[mm]	[mm]
M8	R-STUDS-08110	R-STUDS-08110-88	R-STUDS-08110-A4	8	110	9
	R-STUDS-08160	-	R-STUDS-08160-A4	8	160	9
M10	R-STUDS-10130	R-STUDS-10130-88	R-STUDS-10130-A4	10	130	12
	R-STUDS-10170	-	-	10	170	12
M12	R-STUDS-10190	-	-	10	190	12
	R-STUDS-12160	R-STUDS-12160-88	R-STUDS-12160-A4	12	160	14
	R-STUDS-12190	-	R-STUDS-12190-A4	12	190	14
	R-STUDS-12220	-	-	12	220	14
	R-STUDS-12260	-	-	12	260	14
M16	R-STUDS-12300	-	R-STUDS-12300-A4	12	300	14
	R-STUDS-16190	R-STUDS-16190-88	R-STUDS-16190-A4	16	190	18
	R-STUDS-16220	-	-	16	220	18
	R-STUDS-16260	-	-	16	260	18
	R-STUDS-16300	-	-	16	300	18
	R-STUDS-16380	-	-	16	380	18

R-KEM-II | RM50 WITH THREADED RODS FOR MASONRY

INSTALLATION DATA (cont.)

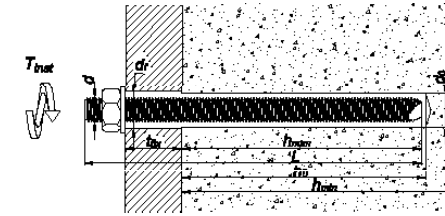

AERATED CONCRETE

Size		M8	M10	M12	M16
Thread diameter	d [mm]	8	10	12	16
Hole diameter in substrate	d ₀ [mm]	10	12	14	18
Installation torque	T _{inst} [Nm]	3	4	6	10
Min. hole depth in substrate	h ₀ [mm]	h _{nom} + 5	h _{nom} + 5	h _{nom} + 5	h _{nom} + 5
Min. installation depth	h _{nom} [mm]	80	85	95	105
Min. spacing	s _{min} [mm]	50	50	50	54
Min. edge distance	c _{min} [mm]	50	50	50	54

CERAMIC SOLID SUBSTRATES

Size		M8	M10	M12	M16
Thread diameter	d [mm]	8	10	12	16
Hole diameter in substrate	d ₀ [mm]	10	12	14	18
Installation torque	T _{inst} [Nm]	5	8	10	15
Min. hole depth in substrate	h ₀ [mm]	h _{nom} + 5	h _{nom} + 5	h _{nom} + 5	h _{nom} + 5
Min. installation depth	h _{nom} [mm]	80	85	95	105
Min. spacing	s _{min} [mm]	50	50	50	54
Min. edge distance	c _{min} [mm]	50	50	50	54

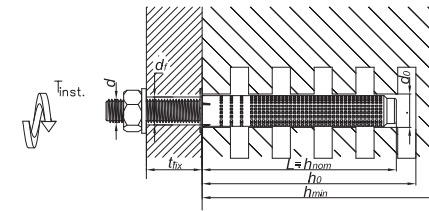

HOLLOW SUBSTRATES

Size		M8	M10	M12	M16
Thread diameter	d [mm]	8	10	12	16
Hole diameter in substrate	d ₀ [mm]	12	16	16	20
Installation torque	T _{inst} [Nm]	3	4	6	10
Min. hole depth in substrate	h ₀ [mm]	h _{nom} + 5	h _{nom} + 5	h _{nom} + 5	h _{nom} + 5
Min. installation depth	h _{nom} [mm]	50	80	85	125
Min. spacing	s _{min} [mm]	100	100	100	120
Min. edge distance	c _{min} [mm]	100	100	100	120
Plastic mesh sleeve size	dxl [mm]	12x50	12x80	16x85	16x130

Minimum working and curing time

Resin temperature [°C]	Concrete temperature [°C]	Curing time* [min]			Working time [min]		
		R-KEMII-S	R-KEMII	R-KEMII-W	R-KEMII-S	R-KEMII	R-KEMII-W
5	-20	-	-	24 h	-	-	45
5	-15	-	-	18 h	-	-	30
5	-10	-	-	8 h	-	-	20
5	-5	24 h	8 h	5 h	3 h	70	11
5	0	18 h	4 h	2 h	2 h	45	7
5	5	12 h	2 h	1 h	1 h	25	5
10	10	8 h	1.5 h	45	45	15	2
15	15	6 h	1 h	30	25	9	1.5
20	20	4 h	45	15	15	5	1
25	30	1.5 h	30	-	7	2	-
25	35	1 h	-	-	6	-	-
25	40	5	-	-	5	-	-

*For wet concrete the curing time must be doubled

R-KEM-II | RM50 WITH THREADED RODS FOR MASONRY

MECHANICAL PROPERTIES

Size			M8	M10	M12	M16
R-STUDS Metric Threaded Rods - Steel Class 5.8						
Nominal ultimate tensile strength - tension	F_{tk}	[N/mm ²]	500	500	500	500
Nominal yield strength - tension	F_{yk}	[N/mm ²]	400	400	400	400
Cross sectional area - tension	A_s	[mm ²]	36.6	58	84.3	157
Elastic section modulus	W_{el}	[mm ³]	31.2	62.3	109.2	277.5
Characteristic bending resistance	$M_{Rk,s}^0$	[Nm]	19	37	65	166
Design bending resistance	M	[Nm]	15	30	52	133
Allowable bending resistance	M_{rec}	[Nm]	11	21	37	95
R-STUDS Metric Threaded Rods - Steel Class 8.8						
Nominal ultimate tensile strength - tension	F_{tk}	[N/mm ²]	800	800	800	800
Nominal yield strength - tension	F_{yk}	[N/mm ²]	640	640	640	640
Cross sectional area - tension	A_s	[mm ²]	36.6	58	84.3	157
Elastic section modulus	W_{el}	[mm ³]	31.2	62.3	109.2	277.5
Characteristic bending resistance	$M_{Rk,s}^0$	[Nm]	30	60	105	266
Design bending resistance	M	[Nm]	24	48	84	213
Allowable bending resistance	M_{rec}	[Nm]	17	34	60	152
R-STUDS Metric Threaded Rods - A4						
Nominal ultimate tensile strength - tension	F_{tk}	[N/mm ²]	700	700	700	700
Nominal yield strength - tension	F_{yk}	[N/mm ²]	350	350	350	350
Cross sectional area - tension	A_s	[mm ²]	36.6	58	84.3	157
Elastic section modulus	W_{el}	[mm ³]	31.2	62.3	109.2	277.5
Characteristic bending resistance	$M_{Rk,s}^0$	[Nm]	26	52	92	233
Design bending resistance	M	[Nm]	17	34	59	149
Allowable bending resistance	M_{rec}	[Nm]	12	24	42	107

BASIC PERFORMANCE DATA

R-STUDS LIGHT

Performance data for single anchor without influence of edge distance and spacing

Size		M8	M10	M12	M16	
Substrate type	-	Hollow substrates				
Plastic mesh sleeve size	[mm]	12x50	12x80	16x85	16x130	20x85
MEAN ULTIMATE LOAD						
TENSION AND SHEAR LOAD F_{Rm}						
Silicate hollow block min 12MPa (eg KS Ratio Block 8 DF)	[kN]	3.42	3.50	3.73	5.11	4.16
Perforated ceramic blocks min 12MPa (eg Proton Hz 12/0.9 DF)	[kN]	3.21	3.54	3.87	4.03	3.97
Perforated ceramic blocks min 15MPa (eg Wienerberger Porotherm)	[kN]	2.04	2.84	3.07	3.68	3.74
Perforated ceramic blocks min 10MPa (eg Leiter Thermopor)	[kN]	2.08	2.98	3.19	3.78	3.68
Perforated ceramic blocks min 15MPa (eg MEGA MAX)	[kN]	2.86	3.43	3.74	3.59	3.71
Perforated ceramic blocks min 6.0MPa (eg LS Tableau Mono Rect)	[kN]	1.24	1.25	2.49	2.74	2.82
Perforated ceramic blocks min 6.0MPa (eg LS Tableau Rect)	[kN]	1.73	1.60	2.37	2.51	2.41
Perforated ceramic blocks min 6.0MPa (eg LS Monomur)	[kN]	1.30	1.39	1.99	2.06	2.05
Perforated ceramic blocks min 6MPa (eg SM BGV Thermo)	[kN]	1.45	1.45	2.22	2.17	2.19
Perforated ceramic blocks min 6.0MPa (eg SM BGV Thermo Plus)	[kN]	1.51	1.60	1.39	1.45	1.86
Lightweight concrete hollow block min 2.0MPa	[kN]	1.73	2.38	3.52	3.00	3.93
Substrate type	-	Hollow substrates				
Plastic mesh sleeve size	[mm]	12x50	12x80	16x85	16x130	20x85
CHARACTERISTIC LOAD						
TENSION AND SHEAR LOAD F_{Rk}						
Silicate hollow block min 12MPa (eg KS Ratio Block 8 DF)	[kN]	2.50	2.50	2.50	3.50	3.00
Perforated ceramic blocks min 12MPa (eg Proton Hz 12/0.9 DF)	[kN]	2.00	2.50	2.50	2.50	2.50
Perforated ceramic blocks min 15MPa (eg Wienerberger Porotherm)	[kN]	1.50	2.00	2.00	2.50	2.50
Perforated ceramic blocks min 10MPa (eg Leiter Thermopor)	[kN]	1.50	2.00	2.00	2.50	2.50
Perforated ceramic blocks min 15MPa (eg MEGA MAX)	[kN]	2.00	2.50	2.50	2.50	2.50
Perforated ceramic blocks min 6.0MPa (eg LS Tableau Mono Rect)	[kN]	0.90	0.90	1.50	2.00	2.00
Perforated ceramic blocks min 6.0MPa (eg LS Tableau Rect)	[kN]	0.90	1.20	1.50	1.50	2.00
Perforated ceramic blocks min 6.0MPa (eg LS Monomur)	[kN]	0.90	0.90	1.20	1.50	1.50
Perforated ceramic blocks min 6MPa (eg SM BGV Thermo)	[kN]	0.90	0.90	1.50	1.50	1.50
Perforated ceramic blocks min 6.0MPa (eg SM BGV Thermo Plus)	[kN]	0.90	1.20	0.90	0.90	1.20
Lightweight concrete hollow block min 2.0MPa	[kN]	1.20	1.50	2.50	2.00	2.50
DESIGN LOAD						
TENSION AND SHEAR LOAD F_{Rd}						
Silicate hollow block min 12MPa (eg KS Ratio Block 8 DF)	[kN]	1.00	1.00	1.00	1.40	1.20
Perforated ceramic blocks min 12MPa (eg Proton Hz 12/0.9 DF)	[kN]	0.88	1.00	1.20	1.40	1.60
Perforated ceramic blocks min 15MPa (eg Wienerberger Porotherm)	[kN]	0.60	0.80	1.00	1.40	1.40
Perforated ceramic blocks min 10MPa (eg Leiter Thermopor)	[kN]	0.60	0.80	0.80	1.00	1.40
Perforated ceramic blocks min 15MPa (eg MEGA MAX)	[kN]	0.80	1.00	1.40	1.60	1.60
Perforated ceramic blocks min 6.0MPa (eg LS Tableau Mono Rect)	[kN]	0.36	0.36	0.80	0.80	0.80
Perforated ceramic blocks min 6.0MPa (eg LS Tableau Rect)	[kN]	0.48	0.48	0.60	0.60	0.80
Perforated ceramic blocks min 6.0MPa (eg LS Monomur)	[kN]	0.36	0.36	0.60	0.60	0.60
Perforated ceramic blocks min 6MPa (eg SM BGV Thermo)	[kN]	0.36	0.36	0.60	0.60	0.60
Perforated ceramic blocks min 6.0MPa (eg SM BGV Thermo Plus)	[kN]	0.48	0.48	0.48	0.48	0.60
Lightweight concrete hollow block min 2.0MPa	[kN]	0.48	0.60	1.00	1.00	1.40

R-KEM-II | RM50 WITH THREADED RODS FOR MASONRY

BASIC PERFORMANCE DATA

Size		M8	M10	M12	M16
RECOMMENDED LOAD					
TENSION AND SHEAR LOAD F_{rec}					
Silicate hollow block min 12MPa (eg KS Ratio Block 8 DF)	[kN]	0.71	0.71	0.71	1.00
Perforated ceramic blocks min 12MPa (eg Proton Hz 12/0.9 DF)	[kN]	0.63	0.71	0.86	1.00
Perforated ceramic blocks min 15MPa (eg Wienerberger Porotherm)	[kN]	0.43	0.57	0.71	1.00
Perforated ceramic blocks min 10MPa (eg Leiter Thermopor)	[kN]	0.43	0.57	0.57	0.71
Perforated ceramic blocks min 15MPa (eg MEGA MAX)	[kN]	0.57	0.71	1.00	1.00
Perforated ceramic blocks min 6.0MPa (eg LS Tableau Mono Rect)	[kN]	0.26	0.26	0.57	0.57
Perforated ceramic blocks min 6.0MPa (eg LS Tableau Rect)	[kN]	0.34	0.34	0.43	0.43
Perforated ceramic blocks min 6.0MPa (eg LS Monomur)	[kN]	0.26	0.26	0.43	0.43
Perforated ceramic blocks min 6MPa (eg SM BGV Thermo)	[kN]	0.26	0.26	0.43	0.43
Perforated ceramic blocks min 6.0MPa (eg SM BGV Thermo Plus)	[kN]	0.34	0.34	0.34	0.34
Lightweight concrete hollow block min 2.0MPa	[kN]	0.34	0.43	0.71	0.71

BASIC PERFORMANCE DATA

R-STUDS LIGHT

Performance data for single anchor without influence of edge distance and spacing

Size		M8	M10	M12	M16	
Substrate type	-	Solid substrates				
Plastic mesh sleeve size	-	-	-	-	-	
MEAN ULTIMATE LOAD						
TENSION LOAD N_{Rm}						
Solid clay brick min 20MPa (eg Mz20/2.0)	[kN]	8.78	10.9	11.3	11.5	
Autoclaved aerated concrete block min 6.0MPa (AAC7)	[kN]	2.65	3.24	4.11	4.68	
Solid silicate brick min 20MPa (eg KS NF 20/2.0)	[kN]	7.54	8.00	8.30	8.50	
SHEAR LOAD V_{Rm}						
Solid clay brick min 20MPa (eg Mz20/2.0)	[kN]	5.79	8.35	11.6	11.5	
Autoclaved aerated concrete block min 6.0MPa (AAC7)	[kN]	2.43	3.41	4.36	4.48	
Solid silicate brick min 20MPa (eg KS NF 20/2.0)	[kN]	5.86	8.11	7.91	8.23	
CHARACTERISTIC LOAD						
TENSION LOAD N_{Rk}						
Solid clay brick min 20MPa (eg Mz20/2.0)	[kN]	6.00	7.00	7.00	7.00	
Autoclaved aerated concrete block min 6.0MPa (AAC7)	[kN]	1.50	2.00	2.50	3.00	
Solid silicate brick min 20MPa (eg KS NF 20/2.0)	[kN]	5.00	5.00	5.00	5.00	
SHEAR LOAD V_{Rk}						
Solid clay brick min 20MPa (eg Mz20/2.0)	[kN]	3.50	5.00	7.00	7.00	
Autoclaved aerated concrete block min 6.0MPa (AAC7)	[kN]	1.50	2.00	2.50	2.50	
Solid silicate brick min 20MPa (eg KS NF 20/2.0)	[kN]	3.50	5.00	5.00	5.00	
DESIGN LOAD						
TENSION LOAD N_{Rd}						
Solid clay brick min 20MPa (eg Mz20/2.0)	[kN]	2.40	2.80	2.80	2.80	
Autoclaved aerated concrete block min 6.0MPa (AAC7)	[kN]	0.75	1.00	1.25	1.50	
Solid silicate brick min 20MPa (eg KS NF 20/2.0)	[kN]	2.00	2.00	2.00	2.00	
SHEAR LOAD V_{Rd}						
Solid clay brick min 20MPa (eg Mz20/2.0)	[kN]	1.40	2.00	2.80	2.80	
Autoclaved aerated concrete block min 6.0MPa (AAC7)	[kN]	0.75	1.00	1.25	1.25	
Solid silicate brick min 20MPa (eg KS NF 20/2.0)	[kN]	1.40	2.00	2.00	2.00	
RECOMMENDED LOAD						
TENSION LOAD N_{rec}						
Solid clay brick min 20MPa (eg Mz20/2.0)	[kN]	1.71	2.00	2.00	2.00	
Autoclaved aerated concrete block min 6.0MPa (AAC7)	[kN]	0.54	0.71	0.89	1.07	
Solid silicate brick min 20MPa (eg KS NF 20/2.0)	[kN]	1.43	1.43	1.43	1.43	
SHEAR LOAD V_{rec}						
Solid clay brick min 20MPa (eg Mz20/2.0)	[kN]	1.00	1.43	2.00	2.00	
Autoclaved aerated concrete block min 6.0MPa (AAC7)	[kN]	0.54	0.71	0.89	0.89	
Solid silicate brick min 20MPa (eg KS NF 20/2.0)	[kN]	1.00	1.43	1.43	1.43	

R-BRUSH MANUAL CLEANING SYSTEM

Brush accessory for cleaning out holes prior to anchor installation



FEATURES AND BENEFITS

- Ideal for cleaning dust from drilled holes prior to applying bonded anchors or installing mechanical anchors
- Hole cleaning is necessary for correct loads
- Suitable for variable anchor embedment depths up to 2,5 m.
- Suitable for repetitive and frequent use.

APPLICATIONS

- Drilling holes in concrete, brick and stone
- Rebar missed-outs
- Rebar
- Post-installed rebar connections
- Formwork installation
- Securing formwork
- Shear dowel connections
- Foundation wall connections
- Renovation and modernization of bridges, buildings.

BASE MATERIALS

- Concrete C12/15-C50/60

INSTALLATION GUIDE

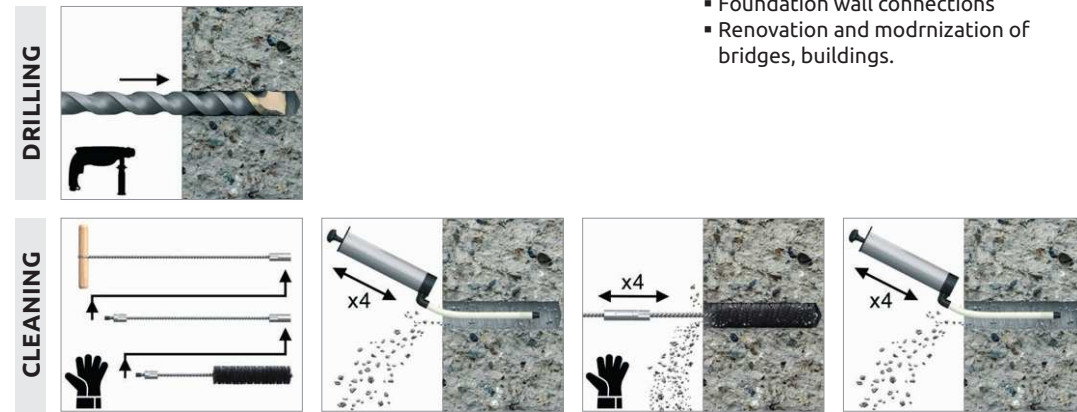

1. Drill hole to the required diameter and depth for stud size being used.
2. Before inserting anchor, clean inside of hole by compressed air starting from the drill hole bottom. Blow the hole at least twice by compressed air at minimum 6 bar.
3. Choose extensions and brushes to the selected depth and diameter of the hole, then combine them into one set.
4. Clean the hole twice with a prepared brush set.
5. Clean the hole again with compressed air.

PRODUCT INFORMATION

Product Code	Length [mm]	Diameter	Drill diameter [mm]	Stud size	Rebar diameter
		D [mm]			d _s [mm]
R-BRUSH-EXT-LH	360	-	-	-	-
R-BRUSH-EXT-LT	360	-	-	-	-
R-BRUSH-12-TC	200	12	10	M8	-
R-BRUSH-14-TC	200	14	12	M10	8
R-BRUSH-16-TC	200	16	14	M12	10
R-BRUSH-18-TC	200	18	16	-	12
R-BRUSH-20-TC	200	20	18	M16	14
R-BRUSH-22-TC	200	22	20	-	16
R-BRUSH-27-TC	200	27	25	M20	20
R-BRUSH-32-TC	200	32	30	M24	25
R-BRUSH-37-TC	200	37	35	M30	28
R-BRUSH-42-TC	200	42	40	-	32
R-BRUSH-52-TC	200	52	50	-	40

R-BRUSH FOR AUTOMATIC CLEANING SYSTEM

System for automatic cleaning deep holes before installing the anchor in a solid substrate

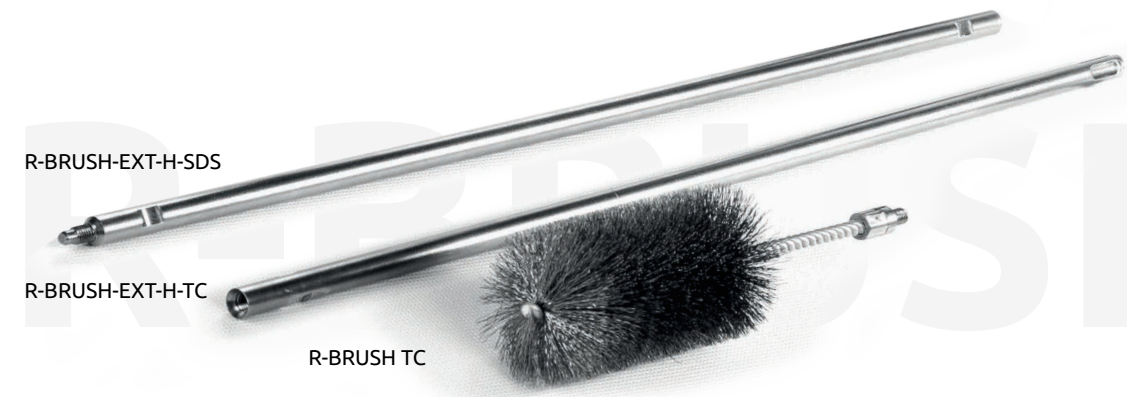

FEATURES AND BENEFITS

- Ideal for serial cleaning of deep holes.
- Ideal for cleaning dust from drilled holes prior to applying bonded anchors or installing mechanical anchors
- Hole cleaning is necessary for correct loads
- Suitable for variable anchor embedment depths.
- Suitable for repetitive and frequent use.

APPLICATIONS

- Drilling holes in concrete, brick and stone
- Rebar
- Rebar missed-outs
- Formwork installation
- Large panel reinforcing system - Copy Eco
- Securing formwork
- Shear dowel connections
- Renovation and modernization of bridges, buildings

BASE MATERIALS

- Concrete C12/15-C50/60

INSTALLATION GUIDE

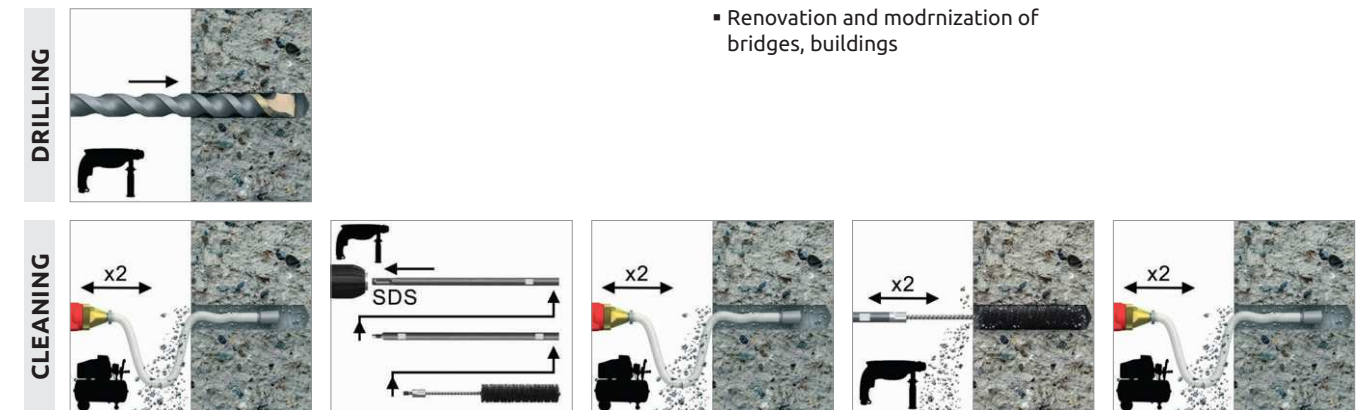

1. Drill hole to the required diameter and depth for stud size being used.
2. Before inserting anchor, clean inside of hole by compressed air starting from the drill hole bottom. Blow the hole at least twice by compressed air at minimum 6 bar.
3. Choose extensions and brushes to the selected depth and diameter of the hole, then combine them into one set.
4. Connect the drill set with the SDS tip.
5. Clean the hole twice with a prepared brush set.
6. Clean the hole again with compressed air.

PRODUCT INFORMATION

Product Code	Length [mm]	Diameter	Drill diameter [mm]	Stud size	Rebar diameter
		D [mm]			d _s [mm]
R-BRUSH-EXT-H-SDS	420	-	-	-	-
R-BRUSH-EXT-H-TC	420	-	-	-	-
R-BRUSH-12-TC	200	12	10	M8	-
R-BRUSH-14-TC	200	14	12	M10	8
R-BRUSH-16-TC	200	16	14	M12	10
R-BRUSH-18-TC	200	18	16	-	12
R-BRUSH-20-TC	200	20	18	M16	14
R-BRUSH-22-TC	200	22	20	-	16
R-BRUSH-27-TC	200	27	25	M20	20
R-BRUSH-32-TC	200	32	30	M24	25
R-BRUSH-37-TC	200	37	35	M30	28
R-BRUSH-42-TC	200	42	40	-	32
R-BRUSH-52-TC	200	52	50	-	40

R-BRUSH MANUAL WIRE BRUSHES

Brush accessory for cleaning out holes prior to anchor installation



FEATURES AND BENEFITS

- Ideal for cleaning dust from drilled holes prior to applying bonded anchors or installing mechanical anchors
- Hole cleaning is necessary for correct loads
- Suitable for variable anchor embedment depths
- Suitable for repetitive and frequent use

INSTALLATION GUIDE

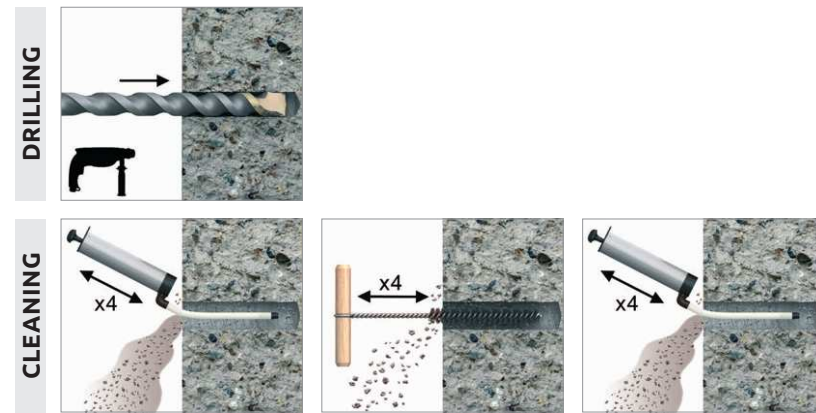

1. Drill hole to the required diameter and depth for stud size being used.
2. Before inserting anchor, clean inside of hole by compressed air starting from the drill hole bottom. Blow the hole at least twice by compressed air at minimum 6 bar.
3. Choose extensions and brushes to the selected depth and diameter of the hole, then combine them into one set.
4. Connect the drill set with the SDS tip.
5. Clean the hole twice with a prepared brush set.
6. Clean the hole again with compressed air.

PRODUCT INFORMATION

Product Code	Drill diameter [mm]	Stud size	Diameter
			D [mm]
R-BRUSH-M08/M	10	M8	12
R-BRUSH-M10/M	12	M10	14
R-BRUSH-M12/M	14	M12	16
R-BRUSH-M16/M	18	M16	20
R-BRUSH-M20/M	24	M20	26
R-BRUSH-M24/M	28	M24	30
R-BRUSH-M30/M	35	M30	37

R-BLOWPUMP BLOW PUMP

Manual blow pump ideal for cleaning dust from drilled holes

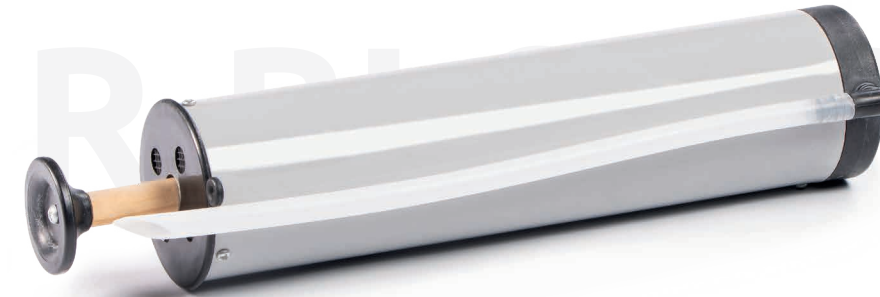

FEATURES AND BENEFITS

- Ideal for cleaning dust from drilled holes prior to applying bonded anchors or installing mechanical anchors
- Hole cleaning is necessary for correct loads
- Manual, easy to use
- Serial application

APPLICATIONS

- Accessory used for cleaning out anchoring holes in concrete and masonry

INSTALLATION GUIDE

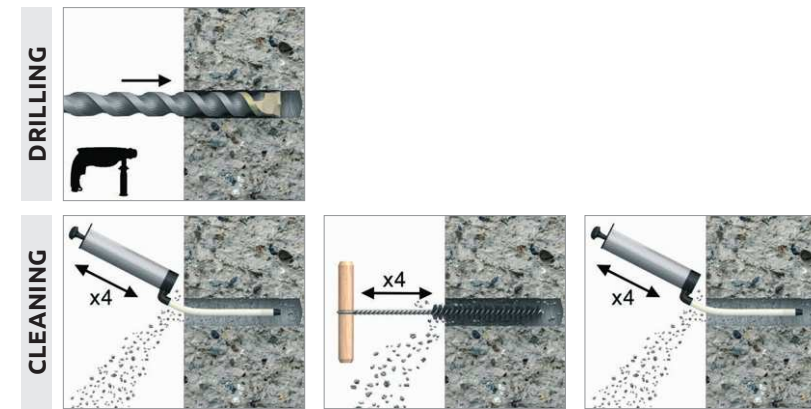

1. Before inserting anchor, clear debris from hole
2. Insert pipe to bottom of hole and pump air repeatedly four times
3. Additional use of hole brush is recommended, four times

PRODUCT INFORMATION

Product Code	Description
R-BLOWPUMP	Manual Blow pump

R-STUDS METRIC THREADED RODS - STEEL CLASS 1.4529 HCR, FLAT HEAD

Threaded rod made out of an austenitic special steel 1.4529 HCR classified in the highest corrosion resistance class



FEATURES AND BENEFITS

- High-performance bonded anchors offer high load-bearing capacities
- Can be post-installed through fixture in some cases. (Consult technical advisory service)
- Flat head for quick manual installation without a setting tool
- Stainless steel 1.4529 HCR is characterized by its high resistance to local corrosion phenomena, such as crevice corrosion, pitting, or chlorine-induced stress corrosion cracking
- It demonstrates excellent mechanical properties and can be used in a wide temperature range
- In contact with sulphuric or phosphoric acid, or chlorides and salts, it offers excellent resilience and resistance to wear

APPLICATIONS

- Shipbuilding
- Offshore technology
- Swimming pool technology
- Plants in the chemical industry
- Heat exchangers and evaporators
- Flue gas desulphurization plants
- Tanks for aggressive chemical products
- Tunnel construction

INSTALLATION GUIDE

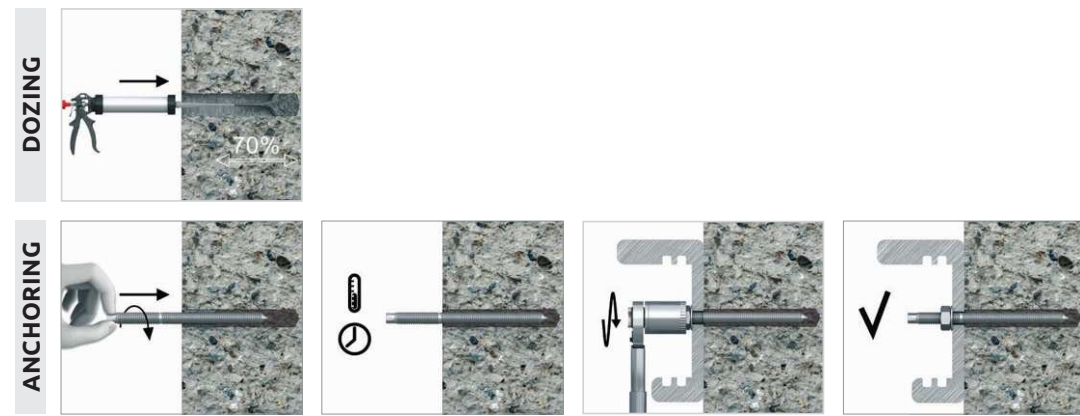

- Drill hole to the required diameter and depth for stud size being used.
- Clean the hole thoroughly with hand pump and hole brush
- If required, insert the mesh sleeve into position
- Fill hole with the required resin to the recommended fill level. (Follow the relevant instructions for the resin product)
- Insert the threaded stud slowly and with a slight twisting motion, until the required embedment depth is reached
- Leave undisturbed until curing time of resin has elapsed
- Attach fixture and tighten the nut to the required installation torque

PRODUCT INFORMATION

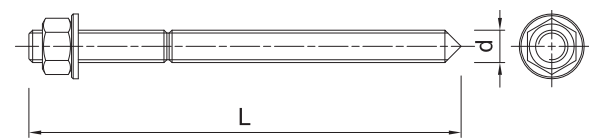

Size	Product Code	Anchor		Fixture				
		Diameter d [mm]	Length L [mm]	Max. thickness t_{fix} for:		Hole diameter d_f [mm]	Max. thickness t_{fix} for:	
				$h_{nom, 6d}$ [mm]	$h_{nom, 12d}$ [mm]		$h_{nom, min}$ [mm]	$h_{nom, 12d}$ [mm]
M8	R-STUDS-08110HCRFL	8	110	52	4	9	40	4
M10	R-STUDS-10130HCRFL	10	130	58	-	12	48	-
M12	R-STUDS-12160HCRFL	12	160	73	1	14	65	1
M16	R-STUDS-16190HCRFL	16	190	75	-	18	71	-
M20	R-STUDS-20260HCRFL	20	260	117	-	22	117	-

R-STUDS METRIC THREADED RODS - STEEL CLASS A4

A4 stainless steel threaded rod for outdoor and damp conditions



FEATURES AND BENEFITS

- High-performance bonded anchors offer high load-bearing capacities
- A4 stainless steel offers improved load-bearing capacities (relative to standard carbon steel)
- Can be post-installed through fixture in some cases. (Consult technical advisory service)
- Hexagonal bit for the wrench with appropriate tightening torque

APPLICATIONS

- Satellite dishes
- Balustrading & handrails
- Barriers
- Safety barriers
- Starter bars
- Gates, wickets, fences
- Stadium seating
- Fixing electrical boxes, sanitary ware, cable trunking, etc.
- Road Signs

INSTALLATION GUIDE

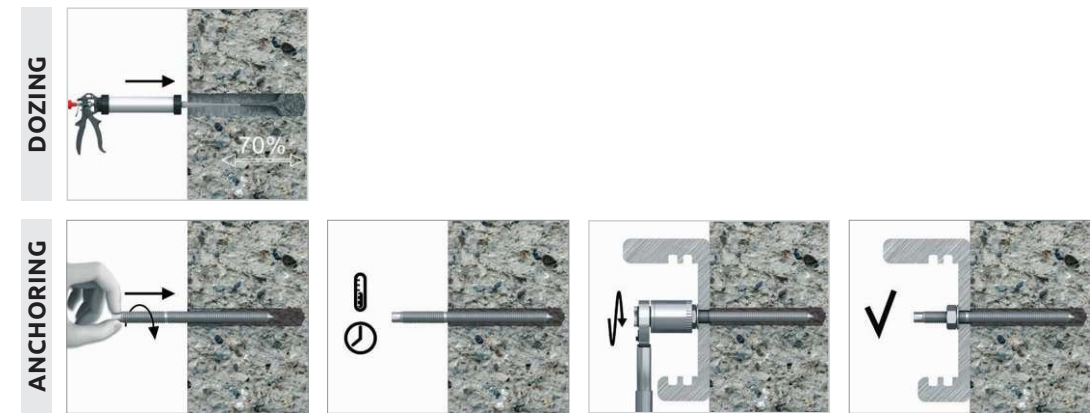

- Drill hole to the required diameter and depth for stud size being used.
- Clean the hole thoroughly with hand pump and hole brush
- If required, insert the mesh sleeve into position
- Fill hole with the required resin to the recommended fill level. (Follow the relevant instructions for the resin product)
- Insert the threaded stud slowly and with a slight twisting motion, until the required embedment depth is reached
- Leave undisturbed until curing time of resin has elapsed
- Attach fixture and tighten the nut to the required installation torque

PRODUCT INFORMATION

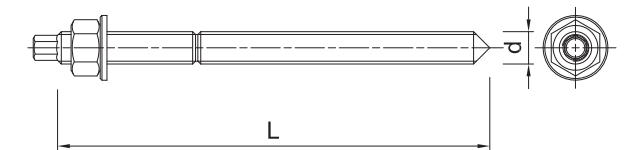

Size	Product Code	Anchor		Fixture				
		Diameter d [mm]	Length L [mm]	Max. thickness t_{fix} for:		Hole diameter d_f [mm]	Max. thickness t_{fix} for:	
				$h_{nom, 6d}$ [mm]	$h_{nom, 12d}$ [mm]		$h_{nom, min}$ [mm]	$h_{nom, 12d}$ [mm]
M8	R-STUDS-08110-A4	8	110	52	4	9	40	4
	R-STUDS-08160-A4	8	160	102	54	9	90	54
M10	R-STUDS-10130-A4	10	130	58	-	12	48	-
M12	R-STUDS-12160-A4	12	160	73	1	14	65	1
	R-STUDS-12300-A4	12	300	213	141	14	205	141
M16	R-STUDS-16190-A4	16	190	75	-	18	71	-
	R-STUDS-20260-A4	20	260	117	-	22	117	-
M24	R-STUDS-24300-A4	24	300	128	-	26	132	-

R-STUDS METRIC THREADED RODS - STEEL CLASS A4, FLAT HEAD

4 stainless steel threaded rod for outdoor and damp conditions



FEATURES AND BENEFITS

- High-performance bonded anchors offer high load-bearing capacities
- A4 stainless steel offers improved load-bearing capacities (relative to standard carbon steel)
- Can be post-installed through fixture in some cases. (Consult technical advisory service)
- Flat head for quick manual installation without a setting tool

APPLICATIONS

- Satellite dishes
- Balustrading & handrails
- Safety barriers
- Starter bars
- Gates, wickets, fences
- Lamps
- Stadium seating
- Gratings
- Fixing electrical boxes, sanitary ware, cable trunking, etc.

INSTALLATION GUIDE

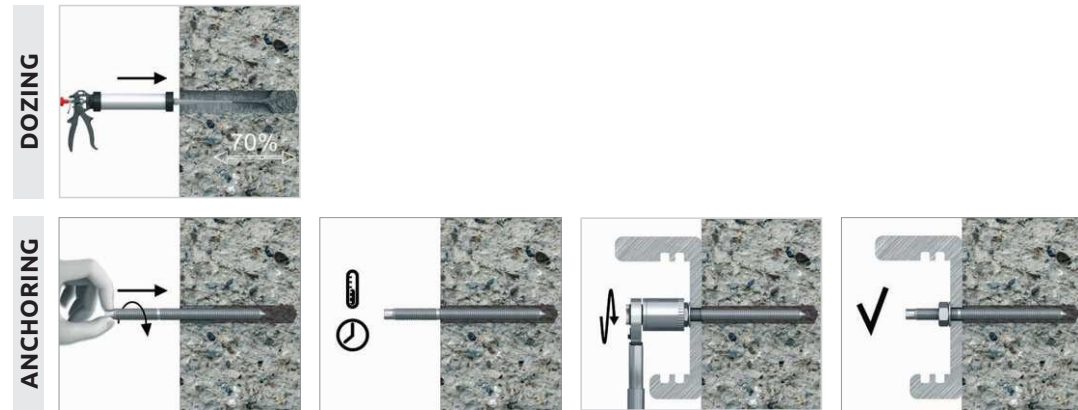

- Drill hole to the required diameter and depth for stud size being used.
- Clean the hole thoroughly with hand pump and hole brush
- If required, insert the mesh sleeve into position
- Fill hole with the required resin to the recommended fill level. (Follow the relevant instructions for the resin product)
- Insert the threaded stud slowly and with a slight twisting motion, until the required embedment depth is reached
- Leave undisturbed until curing time of resin has elapsed
- Attach fixture and tighten the nut to the required installation torque

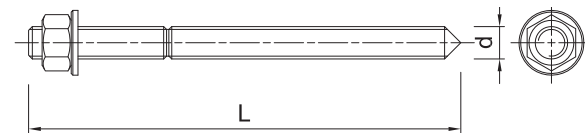

PRODUCT INFORMATION

Size	Product Code	Anchor		Fixture				
		Diameter	Length	Max. thickness t_{fix} for:		Hole diameter	Max. thickness t_{fix} for:	
		d [mm]	L [mm]	$h_{nom, 6d}$ [mm]	$h_{nom, 12d}$ [mm]	d_f [mm]	$h_{nom, min}$ [mm]	$h_{nom, 12d}$ [mm]
M8	R-STUDS-08110-A4FL	8	110	52	4	9	40	4
	R-STUDS-10130-A4FL	10	130	58	-	12	48	-
M10	R-STUDS-10170-A4FL	10	170	98	38	12	88	38
	R-STUDS-10240-A4FL	10	240	168	108	12	158	108
	R-STUDS-10300-A4FL	10	300	228	168	12	218	168
M12	R-STUDS-12140A4FL	12	140	53	-	14	45	-
	R-STUDS-12160-A4FL	12	160	73	1	14	65	1
	R-STUDS-12190-A4FL	12	190	103	31	14	95	31
	R-STUDS-12220-A4FL	12	220	133	61	14	125	61
	R-STUDS-16190-A4FL	16	190	75	-	18	71	-
M16	R-STUDS-16200-A4FL	16	200	85	-	18	81	-
	R-STUDS-16220-A4FL	16	220	105	9	18	101	9
	R-STUDS-16260-A4FL	16	260	145	49	18	141	49
	R-STUDS-20800-A4FL	20	800	657	537	22	657	537
M24	R-STUDS-24300-A4FL	24	300	128	-	26	132	-
M24	R-STUDS-24350-A4FL	24	350	178	34	26	182	34
M30	R-STUDS-30440-A4FF	30	440	226	46	32	241	46

R-STUDS METRIC THREADED RODS - STEEL CLASS A2, FLAT HEAD

A2 stainless steel threaded rod for outdoor and damp conditions



FEATURES AND BENEFITS

- Threaded rod made of A2 stainless steel for outdoor use and in damp conditions
- High-performance bonded anchors offer high load-bearing capacities
- Can be post-installed through fixture in some cases. (Consult technical advisory service)
- Flat head for quick manual installation without a setting tool
- Necessary for use in copy-eco system - reinforcement of suspension rod in large-panel construction systems

APPLICATIONS

- Fastening with bonded anchors
- Supports
- Barriers
- Racking systems
- Consoles
- Railings
- Window elements
- Scaffolding
- Heavy machinery
- Facades
- Copy-eco systems
- Cable trays
- Curtain walling
- Formwork support systems

INSTALLATION GUIDE

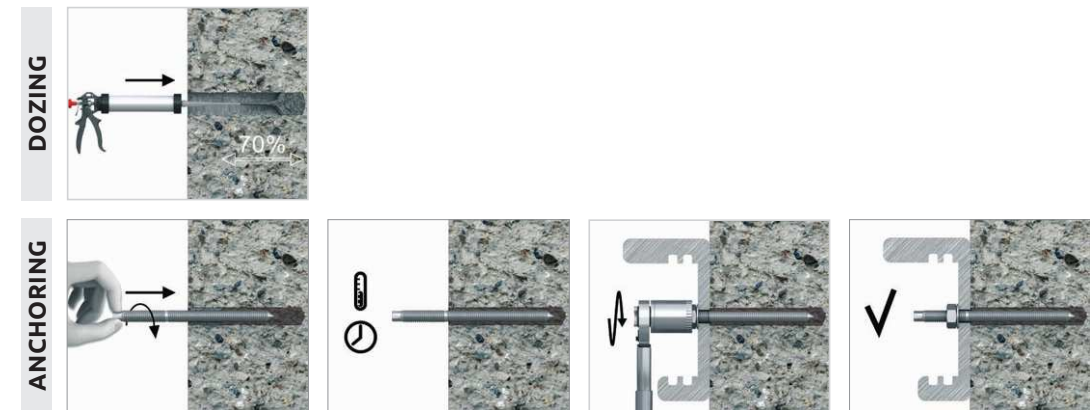

- Drill hole to the required diameter and depth for stud size being used.
- Clean the hole thoroughly with hand pump and hole brush
- If required, insert the mesh sleeve into position
- Fill hole with the required resin to the recommended fill level. (Follow the relevant instructions for the resin product)
- Insert the threaded stud slowly and with a slight twisting motion, until the required embedment depth is reached
- Leave undisturbed until curing time of resin has elapsed
- Attach fixture and tighten the nut to the required installation torque



PRODUCT INFORMATION

Size	Product Code	Anchor		Fixture		
		Diameter	Length	Max. thickness t_{fix} for:		Hole diameter
		d [mm]	L [mm]	$h_{nom, 6d}$ [mm]	$h_{nom, 12d}$ [mm]	d_f [mm]
M10	R-STUDS-10330-A2FL	10	330	258	198	12
	R-STUDS-12140A2FL	12	140	53	-	14
	R-STUDS-12200-A2FL	12	200	113	41	14
	R-STUDS-12220-A2FL	12	220	133	61	14
	R-STUDS-12250-A2FL	12	250	163	91	14
M12	R-STUDS-12260-A2FL	12	260	173	101	14
	R-STUDS-12280-A2FL	12	280	193	121	14
	R-STUDS-12330-A2FL	12	330	243	171	14
	R-STUDS-12350-A2FL	12	350	263	191	14
	R-STUDS-12380-A2FL	12	380	293	221	14
	R-STUDS-12400-A2FL	12	400	313	241	14
	R-STUDS-12440-A2FL	12	440	353	281	14
	R-STUDS-12490-A2FL	12	490	403	331	14
	R-STUDS-12500-A2FL	12	500	413	341	14
	R-STUDS-12550-A2FL	12	550	463	391	14

R-STUDS METRIC THREADED RODS - STEEL CLASS 10.9

Threaded rod 10.9 grade steel for use with bonded anchors



FEATURES AND BENEFITS

- Can be post-installed through fixture in some cases. (Consult technical advisory service)
- Hexagonal head for convenient use with torque wrench
- Threaded rod made of carbon steel class 10.9 is suitable for outdoor use and in damp conditions
- Class 10.9 provides much more greater tensile and yield strength than the ordinary class 8.8
- Threaded rods provide high strength and good wear resistance

APPLICATIONS

- Oil and gas industry
- Pharmaceutical processing industry
- Fastening with bonded anchors
- Barriers
- Curtain walling
- Heavy machinery
- Safety barriers
- Public seating
- Heat exchangers

INSTALLATION GUIDE

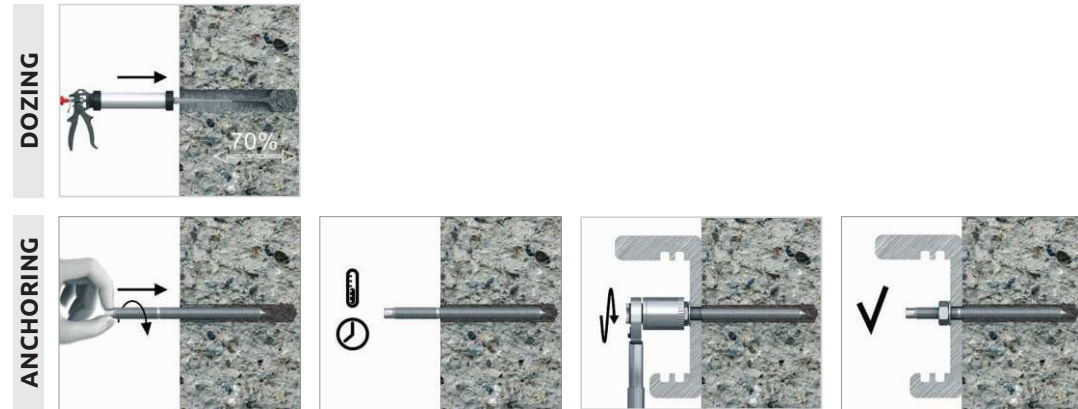

- Drill hole to the required diameter and depth for stud size being used.
- Clean the hole thoroughly with hand pump and hole brush
- If required, insert the mesh sleeve into position
- Fill hole with the required resin to the recommended fill level. (Follow the relevant instructions for the resin product)
- Insert the threaded stud slowly and with a slight twisting motion, until the required embedment depth is reached
- Leave undisturbed until curing time of resin has elapsed
- Attach fixture and tighten the nut to the required installation torque

PRODUCT INFORMATION

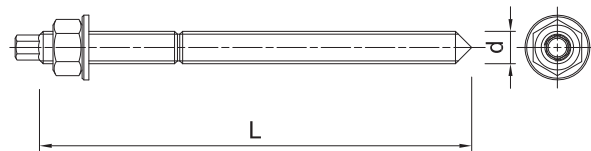

Size	Product Code	Anchor		Fixture				
		Diameter	Length	Max. thickness t_{fix} for:		Hole diameter	Max. thickness t_{fix} for:	
		d [mm]	L [mm]	$h_{nom,6d}$ [mm]	$h_{nom,12d}$ [mm]	d_f [mm]	$h_{nom,min}$ [mm]	$h_{nom,12d}$ [mm]
M22	R-STUDS-22280-109	22	280	123	-	24	123	-
	R-STUDS-22300-109	22	300	143	11	24	143	11
	R-STUDS-22350-109	22	350	193	61	24	193	61

R-STUDS METRIC THREADED RODS - STEEL CLASS 10.9, FLAT HEAD

Threaded rod 10.9 grade steel for use with bonded anchors



FEATURES AND BENEFITS

- Can be post-installed through fixture in some cases. (Consult technical advisory service)
- Flat head for quick manual installation without a setting tool
- Threaded rod made of carbon steel class 10.9 is suitable for outdoor use and in damp conditions
- Class 10.9 provides much more greater tensile and yield strength than the ordinary class 8.8
- Threaded rods provide high strength and good wear resistance

APPLICATIONS

- Oil and gas industry
- Pharmaceutical processing industry
- Fastening with bonded anchors
- Barriers
- Curtain walling
- Heavy machinery
- Safety barriers
- Public seating
- Heat exchangers

INSTALLATION GUIDE

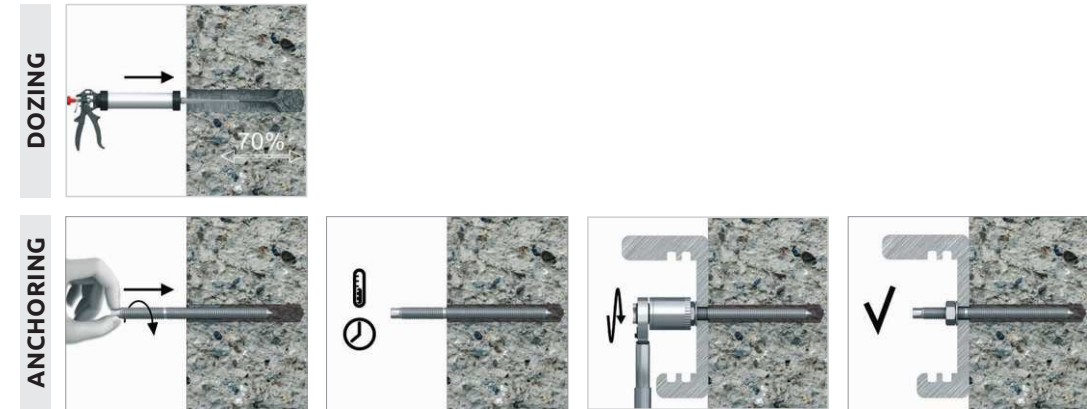

- Drill hole to the required diameter and depth for stud size being used.
- Clean the hole thoroughly with hand pump and hole brush
- If required, insert the mesh sleeve into position
- Fill hole with the required resin to the recommended fill level. (Follow the relevant instructions for the resin product)
- Insert the threaded stud slowly and with a slight twisting motion, until the required embedment depth is reached
- Leave undisturbed until curing time of resin has elapsed
- Attach fixture and tighten the nut to the required installation torque

PRODUCT INFORMATION

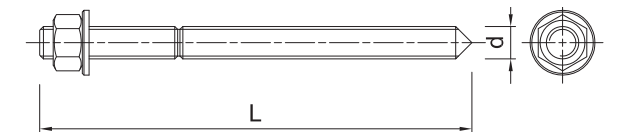

Size	Product Code	Anchor		Fixture				
		Diameter	Length	Max. thickness t_{fix} for:		Hole diameter	Max. thickness t_{fix} for:	
		d [mm]	L [mm]	$h_{nom,6d}$ [mm]	$h_{nom,12d}$ [mm]	d_f [mm]	$h_{nom,min}$ [mm]	$h_{nom,12d}$ [mm]
M20	R-STUDS-20200109FL	20	200	57	-	22	57	-

R-STUDS METRIC THREADED RODS - STEEL CLASS 8.8

Threaded rod 8.8 grade steel for use with bonded anchors.



FEATURES AND BENEFITS

- Threaded rod made of carbon steel class 8.8 is suitable for outdoor use and in damp conditions
- Can be post-installed through fixture in some cases. (Consult technical advisory service)
- Hexagonal head for convenient use with torque wrench

APPLICATIONS

- Fastening with bonded anchors
- Balustrading & handrails
- Barriers
- Cable trays
- Consoles
- Curtain walling
- Formwork support systems
- Heavy machinery
- Lamps
- Safety barriers
- Road Signs
- Railings
- Public seating

INSTALLATION GUIDE

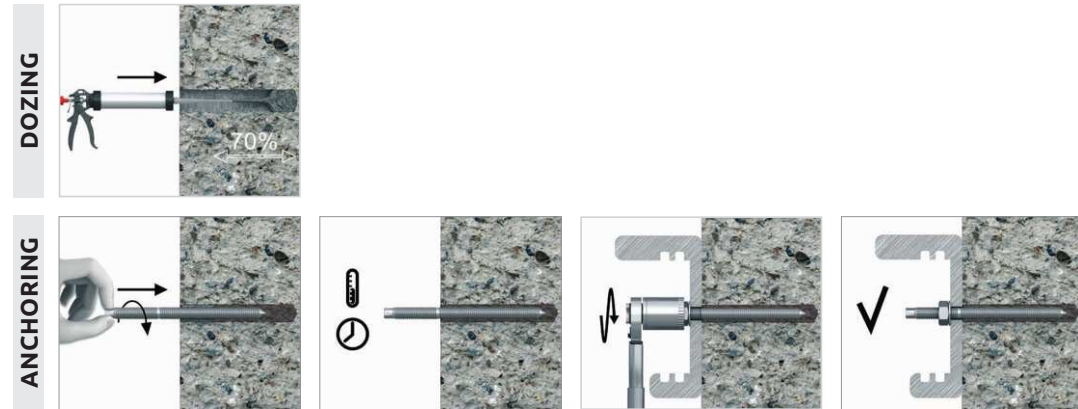

1. Drill hole to the required diameter and depth for stud size being used.
2. Clean the hole thoroughly with hand pump and hole brush
3. If required, insert the mesh sleeve into position
4. Fill hole with the required resin to the recommended fill level. (Follow the relevant instructions for the resin product)
5. Insert the threaded stud slowly and with a slight twisting motion, until the required embedment depth is reached
6. Leave undisturbed until curing time of resin has elapsed
7. Attach fixture and tighten the nut to the required installation torque

PRODUCT INFORMATION

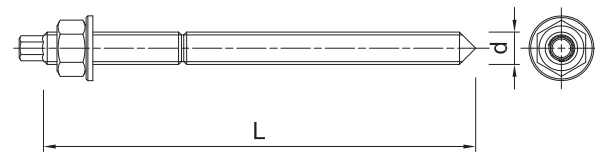

Size	Product Code	Anchor		Fixture				
		Diameter d	Length L	Max. thickness t_{fix} for:		Hole diameter d_f	Max. thickness t_{fix} for:	
				$h_{nom, 6d}$	$h_{nom, 12d}$		$h_{nom, min}$	$h_{nom, 12d}$
[mm]	[mm]	[mm]	[mm]	[mm]	[mm]	[mm]	[mm]	
M8	R-STUDS-08110-88	8	110	52	4	9	40	4
M10	R-STUDS-10130-88	10	130	58	-	12	48	-
M12	R-STUDS-12160-88	12	160	73	1	14	65	1
	R-STUDS-12300-88	12	300	213	141	14	205	141
M16	R-STUDS-16190-88	16	190	75	-	18	71	-
	R-STUDS-16220-88	16	220	105	9	18	101	9
M20	R-STUDS-20220-88	20	220	77	-	22	77	-
	R-STUDS-20260-88	20	260	117	-	22	117	-
M24	R-STUDS-20300-88	20	300	157	37	22	157	37
	R-STUDS-24300-88	24	300	128	-	26	132	-
M30	R-STUDS-30380-88	30	380	166	-	32	181	-
	R-STUDS-30710-88FL	30	710	496	316	32	511	316

R-STUDS METRIC THREADED RODS - STEEL CLASS 8.8, FLAT HEAD

Threaded rod 8.8 grade steel for use with bonded anchors



FEATURES AND BENEFITS

- Threaded rod made of carbon steel class 8.8 is suitable for outdoor use and in damp conditions
- Possibility of removal when used with internally threaded socket
- Can be post-installed through fixture in some cases. (Consult technical advisory service)
- No screwdriver needed for installation

APPLICATIONS

- Fastening with bonded anchors
- Balustrading & handrails
- Barriers
- Cable trays
- Consoles
- Curtain walling
- Formwork support systems
- Heavy machinery
- Lamps
- Safety barriers
- Road Signs
- Railings
- Public seating
- Copy-eco systems

INSTALLATION GUIDE

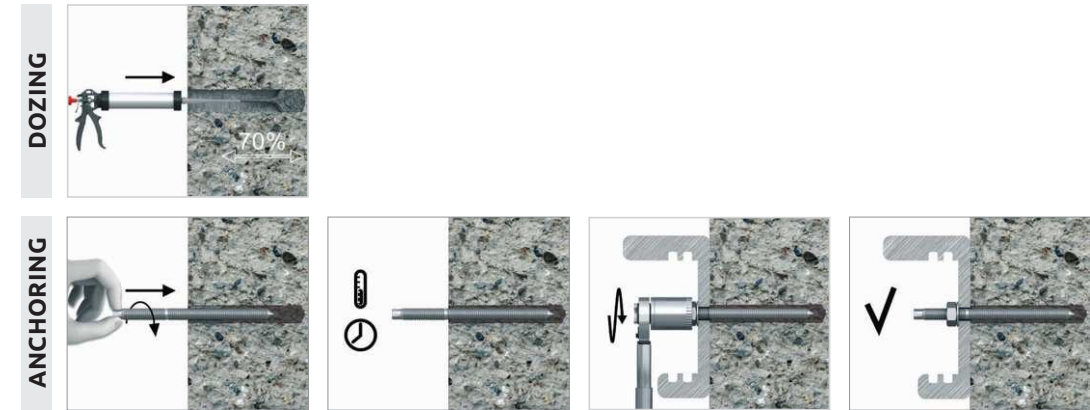

1. Drill hole to the required diameter and depth for stud size being used.
2. Clean the hole thoroughly with hand pump and hole brush
3. If required, insert the mesh sleeve into position
4. Fill hole with the required resin to the recommended fill level. (Follow the relevant instructions for the resin product)
5. Insert the threaded stud slowly and with a slight twisting motion, until the required embedment depth is reached
6. Leave undisturbed until curing time of resin has elapsed
7. Attach fixture and tighten the nut to the required installation torque

PRODUCT INFORMATION

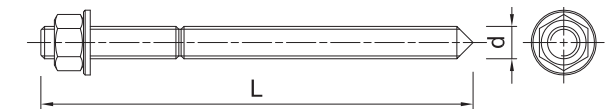

Size	Product Code	Anchor		Fixture				
		Diameter d	Length L	Max. thickness t_{fix} for:		Hole diameter d_f	Max. thickness t_{fix} for:	
				$h_{nom, 6d}$	$h_{nom, 12d}$		$h_{nom, min}$	$h_{nom, 12d}$
[mm]	[mm]	[mm]	[mm]	[mm]	[mm]	[mm]	[mm]	
M8	R-STUDS-08130-88FL	8	130	72	24	9	60	24
M10	R-STUDS-10130-88FL	10	130	58	-	12	48	-
	R-STUDS-10190-88FL	10	190	118	58	12	108	58
M12	R-STUDS-12260-88FL	12	260	173	101	14	165	101
	R-STUDS-16150-88FL	16	150	35	-	18	31	-
M16	R-STUDS-16190-88FL	16	190	75	-	18	71	-
	R-STUDS-16200-88FL	16	200	85	-	18	81	-
	R-STUDS-16220-88FL	16	220	105	9	18	101	9
	R-STUDS-16260-88FL	16	260	145	49	18	141	49
	R-STUDS-16300-88FL	16	300	185	89	18	181	89
	R-STUDS-16450-88FL	16	450	335	239	18	331	239
M20	R-STUDS-16500-88FL	16	500	385	289	18	381	289
	R-STUDS-20260-88FL	20	260	117	-	22	117	-
	R-STUDS-20350-88FL	20	350	207	87	22	207	87
	R-STUDS-20450-88FL	20	450	307	187	22	307	187
	R-STUDS-20500-88FL	20	500	357	237	22	357	237
M24	R-STUDS-20600-88FL	20	600	457	337	22	457	337
	R-STUDS-24300-88FL	24	300	128	-	26	132	-
M24	R-STUDS-24600-88FL	24	600	428	284	26	432	284
	R-STUDS-30380-88FL	30	380	166	-	32	181	-
M30	R-STUDS-30380-88FL	30	380	166	-	32	181	-
	R-STUDS-30710-88FL	30	710	496	316	32	511	316

R-STUDS METRIC THREADED RODS - STEEL CLASS 8.8, HOT DIP GALVANIZED

Threaded rod 8.8 grade steel, hot-dip galvanized (HDG) with increased corrosion resistance, for use with bonded anchors



FEATURES AND BENEFITS

- Threaded rod made of hot dip galvanized steel is suitable for outdoor use and in damp conditions
- Can be post-installed through fixture in some cases. (Consult technical advisory service)
- Hexagonal head for convenient use with torque wrench

APPLICATIONS

- Fastening with bonded anchors
- Balustrading & handrails
- Barriers
- Cable trays
- Consoles
- Curtain walling
- Formwork support systems
- Heavy machinery
- Lamps
- Safety barriers
- Road Signs
- Railings
- Public seating

INSTALLATION GUIDE

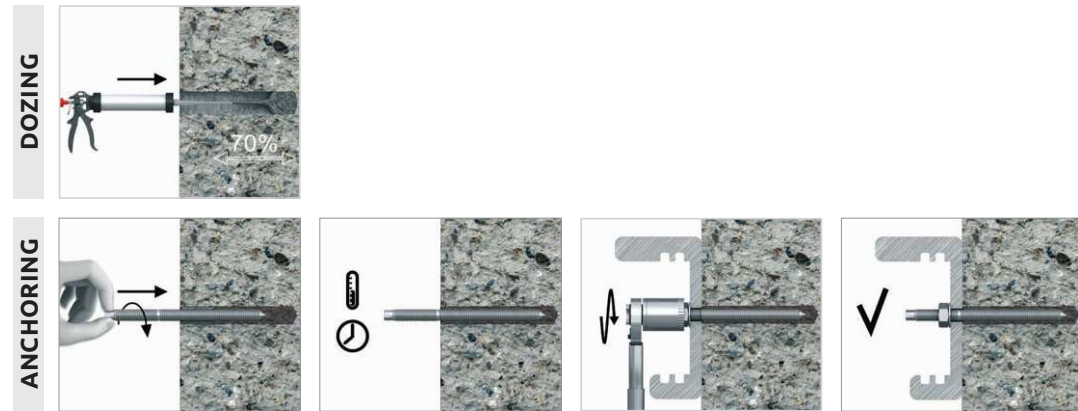

1. Drill hole to the required diameter and depth for stud size being used.
2. Clean the hole thoroughly with hand pump and hole brush
3. If required, insert the mesh sleeve into position
4. Fill hole with the required resin to the recommended fill level. (Follow the relevant instructions for the resin product)
5. Insert the threaded stud slowly and with a slight twisting motion, until the required embedment depth is reached
6. Leave undisturbed until curing time of resin has elapsed
7. Attach fixture and tighten the nut to the required installation torque

PRODUCT INFORMATION

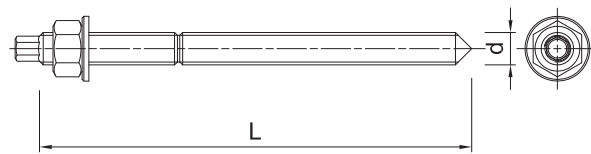

Size	Product Code	Anchor		Fixture				
		Diameter d [mm]	Length L [mm]	Max. thickness t_{fix} for:		Hole diameter d_f [mm]	Max. thickness t_{fix} for:	
				$h_{nom, 6d}$ [mm]	$h_{nom, 12d}$ [mm]		$h_{nom, min}$ [mm]	$h_{nom, 12d}$ [mm]
M8	R-STUDS-0816088ZFF	8	160	102	54	9	90	54
M10	R-STUDS-1013088ZFF	10	130	58	-	12	48	-
	R-STUDS-1211088ZFF	12	110	23	-	14	15	-
M12	R-STUDS-1216088ZFF	12	160	73	1	14	65	1
	R-STUDS-1220088ZFF	12	200	113	41	14	105	41
	R-STUDS-1222088ZFF	12	220	133	61	14	125	61
	R-STUDS-1233088ZFF	12	330	243	171	14	235	171
	R-STUDS-1235088ZFF	12	350	263	191	14	255	191
	R-STUDS-1238088ZFF	12	380	293	221	14	285	221
	R-STUDS-1240088ZFF	12	400	313	241	14	305	241

R-STUDS METRIC THREADED RODS - STEEL CLASS 8.8, HOT DIP GALVANIZED, FLAT HEAD

Threaded rod 8.8 grade steel, hot-dip galvanized (HDG) with increased corrosion resistance, for use with bonded anchors



FEATURES AND BENEFITS

- Threaded rod made of hot dip galvanized steel is suitable for outdoor use and in damp conditions
- Can be post-installed through fixture in some cases. (Consult technical advisory service)

APPLICATIONS

- Fastening with bonded anchors
- Balustrading & handrails
- Barriers
- Cable trays
- Consoles
- Curtain walling
- Formwork support systems
- Heavy machinery
- Lamps
- Safety barriers
- Road Signs
- Railings
- Public seating

INSTALLATION GUIDE

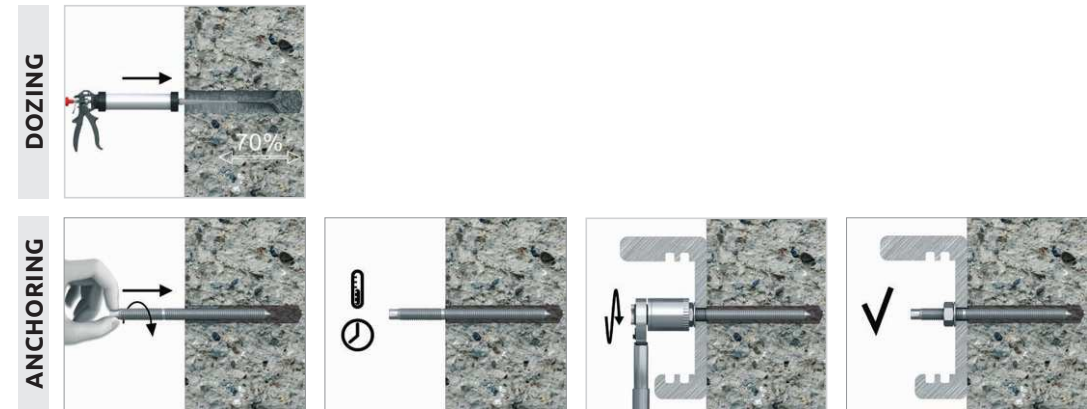

1. Drill hole to the required diameter and depth for stud size being used.
2. Clean the hole thoroughly with hand pump and hole brush
3. If required, insert the mesh sleeve into position
4. Fill hole with the required resin to the recommended fill level. (Follow the relevant instructions for the resin product)
5. Insert the threaded stud slowly and with a slight twisting motion, until the required embedment depth is reached
6. Leave undisturbed until curing time of resin has elapsed
7. Attach fixture and tighten the nut to the required installation torque

PRODUCT INFORMATION

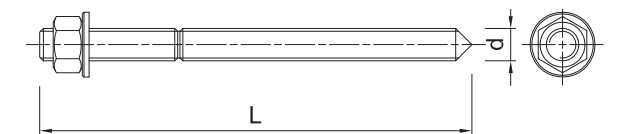

Size	Product Code	Anchor		Fixture				
		Diameter d [mm]	Length L [mm]	Max. thickness t_{fix} for:		Hole diameter d_f [mm]	Max. thickness t_{fix} for:	
				$h_{nom, 6d}$ [mm]	$h_{nom, 12d}$ [mm]		$h_{nom, min}$ [mm]	$h_{nom, 12d}$ [mm]
M12	R-STUDS-1235088HDF	12	350	263	191	14		
M16	R-STUDS-1621088HDF	16	210	95	-	18		
	R-STUDS-1622088HDF	16	220	105	9	18		
	R-STUDS-1626088HDF	16	260	145	49	18		
M20	R-STUDS-1640088HDF	16	400	285	189	18		
	R-STUDS-2026088HDF	20	260	117	-	22		
	R-STUDS-2030088HDF	20	300	157	37	22		
	R-STUDS-2032088HDF	20	320	177	57	22		

R-STUDS METRIC THREADED RODS

- STEEL CLASS 8.8, ZINC FLAKE, FLAT HEAD

Threaded rod 8.8 grade steel, zinc flake (ZF) with increased corrosion resistance, for use with bonded anchors

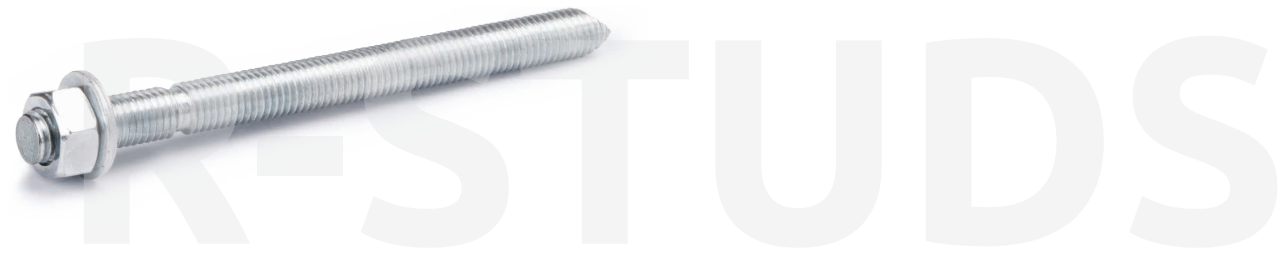

FEATURES AND BENEFITS

- Special zinc flake corrosion-resistant coating
- Can be post-installed through fixture in some cases. (Consult technical advisory service)

APPLICATIONS

- Fastening with bonded anchors
- Balustrading & handrails
- Barriers
- Cable trays
- Consoles
- Curtain walling
- Formwork support systems
- Heavy machinery
- Lamps
- Safety barriers
- Road Signs
- Railings
- Public seating

INSTALLATION GUIDE

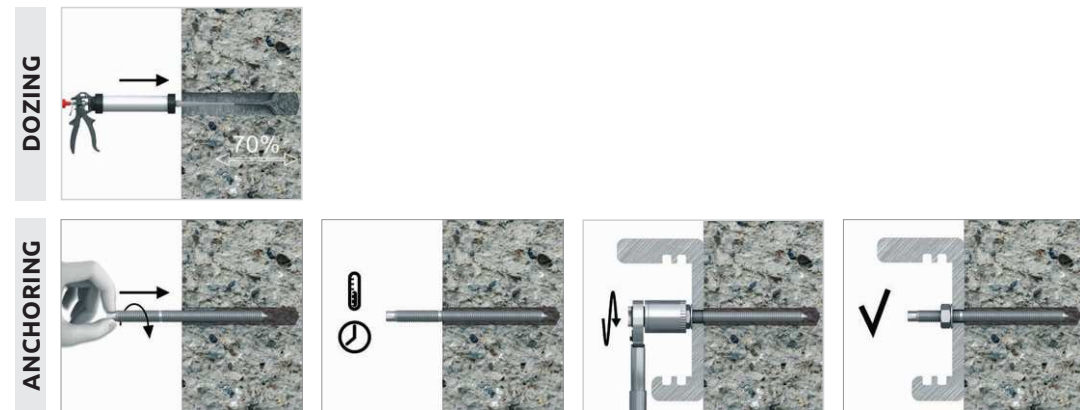

- Drill hole to the required diameter and depth for stud size being used.
- Clean the hole thoroughly with hand pump and hole brush
- If required, insert the mesh sleeve into position
- Fill hole with the required resin to the recommended fill level. (Follow the relevant instructions for the resin product)
- Insert the threaded stud slowly and with a slight twisting motion, until the required embedment depth is reached
- Leave undisturbed until curing time of resin has elapsed
- Attach fixture and tighten the nut to the required installation torque

PRODUCT INFORMATION

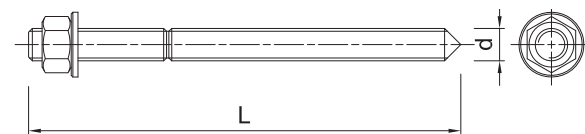

Size	Product Code	Anchor		Fixture				
		Diameter	Length	Max. thickness t_{fix} for:		Hole diameter	Max. thickness t_{fix} for:	
				$h_{nom, 6d}$	$h_{nom, 12d}$		d_f	$h_{nom, min}$
M8	R-STUDS-0816088ZFF	8	160	102	54	9	90	54
M10	R-STUDS-1013088ZFF	10	130	58	-	12	48	-
	R-STUDS-1211088ZFF	12	110	23	-	14	15	-
M12	R-STUDS-1216088ZFF	12	160	73	1	14	65	1
	R-STUDS-1220088ZFF	12	200	113	41	14	105	41
	R-STUDS-1222088ZFF	12	220	133	61	14	125	61
	R-STUDS-1226088ZFF	12	260	173	101	14	165	101
	R-STUDS-1230088ZFF	12	300	213	141	14	205	141
	R-STUDS-1235088ZFF	12	350	263	191	14	255	191
	R-STUDS-1238088ZFF	12	380	293	221	14	285	221
	R-STUDS-1240088ZFF	12	400	313	241	14	305	241

R-STUDS METRIC THREADED RODS

- STEEL CLASS 5.8

Threaded rod 5.8 grade steel for use with bonded anchors



FEATURES AND BENEFITS

- High-performance bonded anchors offer high load-bearing capacities
- Suitable for use with special mesh sleeves in hollow substrates.
- Can be post-installed through fixture in some cases. (Consult technical advisory service)
- Hexagonal head for convenient use with torque wrench
- Possibility of removal when used with internally threaded socket

APPLICATIONS

- Balustrading & handrails
- Supports
- Barriers
- Racking systems
- Consoles
- Railings
- Window elements
- Scaffolding
- Heavy machinery
- Facades
- Copy-eco systems
- Cable trays
- Curtain walling
- Formwork support systems
- Lamps
- Safety barriers
- Road Signs

INSTALLATION GUIDE

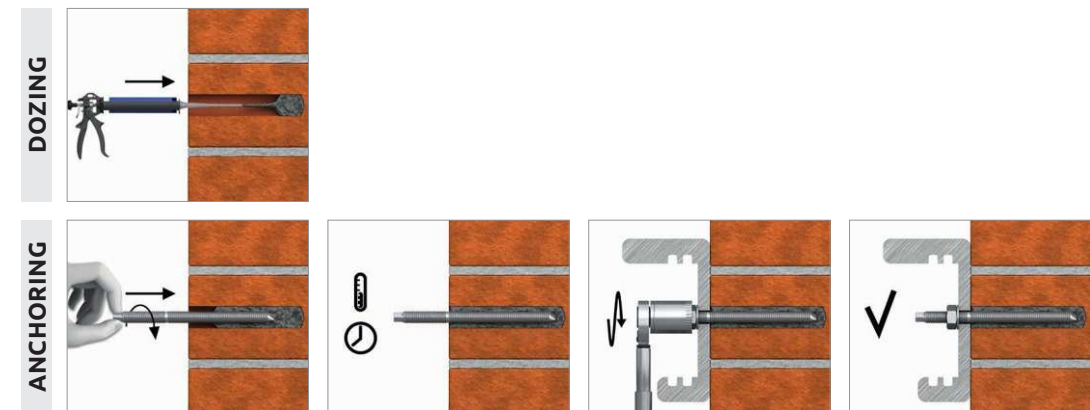

- Drill hole to the required diameter and depth for stud size being used.
- Clean the hole thoroughly with hand pump and hole brush
- If required, insert the mesh sleeve into position
- Fill hole with the required resin to the recommended fill level. (Follow the relevant instructions for the resin product)
- Insert the threaded stud slowly and with a slight twisting motion, until the required embedment depth is reached
- Leave undisturbed until curing time of resin has elapsed
- Attach fixture and tighten the nut to the required installation torque

PRODUCT INFORMATION

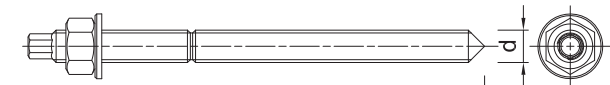

Size	Product Code	Anchor		Fixture				
		Diameter	Length	Max. thickness t_{fix} for:		Hole diameter	Max. thickness t_{fix} for:	
				$h_{nom, 6d}$	$h_{nom, 12d}$		d_f	$h_{nom, min}$
M8	R-STUDS-081110	8	110	52	4	9	40	4
	R-STUDS-08160	8	160	102	54	9	90	54
M10	R-STUDS-10130	10	130	58	-	12	48	-
	R-STUDS-10170	10	170	98	38	12	88	38
M12	R-STUDS-10190	10	190	118	58	12	108	58
	R-STUDS-12160	12	160	73	1	14	65	1
	R-STUDS-12190	12	190	103	31	14	95	31
	R-STUDS-12220	12	220	133	61	14	145	61
	R-STUDS-12260	12	260	173	101	14	165	101
	R-STUDS-12300	12	300	213	141	14	205	141
	R-STUDS-16190	16	190	75	-	18	71	-
	R-STUDS-16220	16	220	105	9	18	101	9
M16	R-STUDS-16260	16	260	145	49	18	141	49
	R-STUDS-16300	16	300	185	89	18	181	89
	R-STUDS-16380	16	380	265	169	18	261	169
	R-STUDS-20260	20	260	117	-	22	117	-
M20	R-STUDS-20300	20	300	157	37	22	157	37
	R-STUDS-20350	20	350	207	87	22	207	87
M24	R-STUDS-24300	24	300	128	-	26	132	-
M30	R-STUDS-30380	30	380	166	-	32	181	-

R-STUDS METRIC THREADED RODS

- STEEL CLASS 8.8, ZINC FLAKE, FLAT HEAD

Threaded rod 5.8 grade steel for use with bonded anchors



FEATURES AND BENEFITS

- High-performance bonded anchors offer high load-bearing capacities
- Suitable for use with special mesh sleeves in hollow substrates
- Flat head for quick manual installation without a setting tool
- Can be post-installed through fixture in some cases. (Consult technical advisory service)
- Possibility of removal when used with internally threaded socket

APPLICATIONS

- Fastening with bonded anchors
- Supports
- Barriers
- Racking systems
- Consoles
- Railings
- Window elements
- Scaffolding
- Heavy machinery

INSTALLATION GUIDE

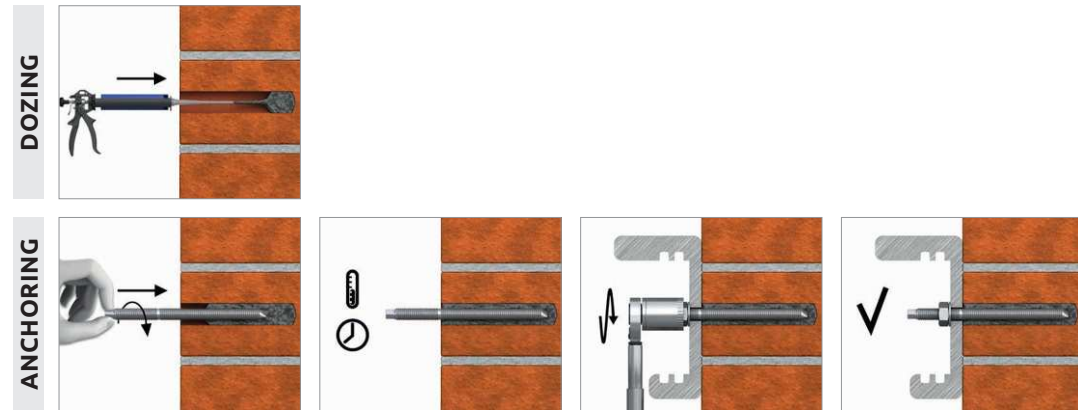

- Drill hole to the required diameter and depth for stud size being used.
- Clean the hole thoroughly with hand pump and hole brush
- If required, insert the mesh sleeve into position
- Fill hole with the required resin to the recommended fill level. (Follow the relevant instructions for the resin product)
- Insert the threaded stud slowly and with a slight twisting motion, until the required embedment depth is reached
- Leave undisturbed until curing time of resin has elapsed
- Attach fixture and tighten the nut to the required installation torque



PRODUCT INFORMATION

Size	Product Code	Anchor		Fixture				
		Diameter	Length	Max. thickness t_{fix} for:		Hole diameter	Max. thickness t_{fix} for:	
		d [mm]	L [mm]	$h_{nom, 6d}$ [mm]	$h_{nom, 12d}$ [mm]	d_f [mm]	$h_{nom, min}$ [mm]	$h_{nom, 12d}$ [mm]
M8	R-STUDS-08110-FL	8	110	52	4	9	40	4
	R-STUDS-08160-FL	8	160	102	54	9	90	54
	R-STUDS-10080-FL	10	80	8	-	12	-	-
M10	R-STUDS-10130-FL	10	130	58	-	12	48	-
	R-STUDS-10170-FL	10	170	98	38	12	88	38
	R-STUDS-10280-FL	10	280	208	148	12	198	148
M12	R-STUDS-12110-FL	12	110	23	-	14	15	-
	R-STUDS-12160-FL	12	160	73	1	14	65	1
	R-STUDS-12190-FL	12	190	103	31	14	95	31
	R-STUDS-12220-FL	12	220	133	61	14	125	61
	R-STUDS-12260-FL	12	260	173	101	14	165	101
M16	R-STUDS-16190-FL	16	190	75	-	18	71	-
	R-STUDS-16220-FL	16	220	105	9	18	101	9
	R-STUDS-16260-FL	16	260	145	49	18	141	49
M20	R-STUDS-20260-FL	20	260	117	-	22	117	-
	R-STUDS-20300-FL	20	300	157	37	22	157	37
	R-STUDS-20350-FL	20	350	207	87	22	207	87
M24	R-STUDS-24300-FL	24	300	128	-	26	132	-
M30	R-STUDS-30380-FL	30	380	166	-	32	181	-

R-STUDS METRIC THREADED RODS

- STEEL CLASS 5.8, HOT DIP GALVANIZED

Threaded rod 5.8 grade steel, hot-dip galvanized (HDG) with increased corrosion resistance, for use with bonded anchors



FEATURES AND BENEFITS

- Threaded rod made of hot dip galvanized steel is suitable for outdoor use and in damp conditions
- Hexagonal head for convenient use with torque wrench

APPLICATIONS

- Fastening with bonded anchors
- Balustrading & handrails
- Barriers
- Cable trays
- Consoles
- Curtain walling
- Formwork support systems
- Heavy machinery
- Lamps
- Safety barriers
- Road Signs
- Railings
- Public seating

INSTALLATION GUIDE

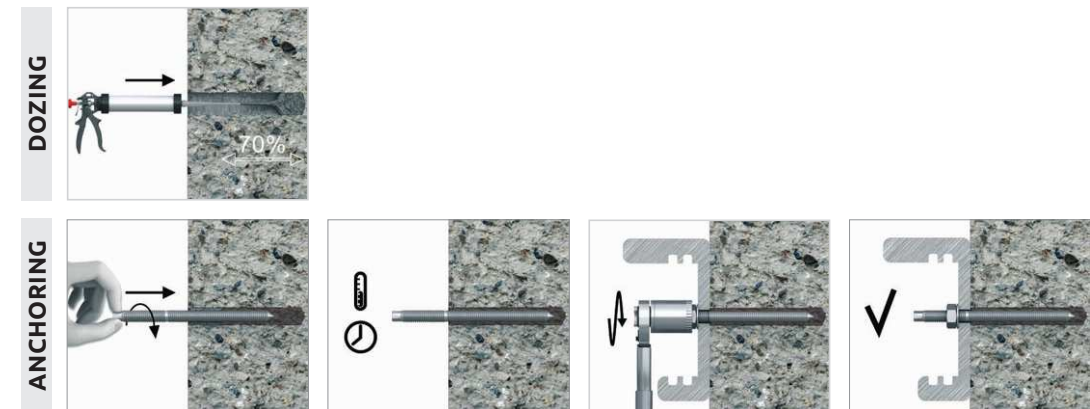

- Drill hole to the required diameter and depth for stud size being used.
- Clean the hole thoroughly with hand pump and hole brush
- If required, insert the mesh sleeve into position
- Fill hole with the required resin to the recommended fill level. (Follow the relevant instructions for the resin product)
- Insert the threaded stud slowly and with a slight twisting motion, until the required embedment depth is reached
- Leave undisturbed until curing time of resin has elapsed
- Attach fixture and tighten the nut to the required installation torque

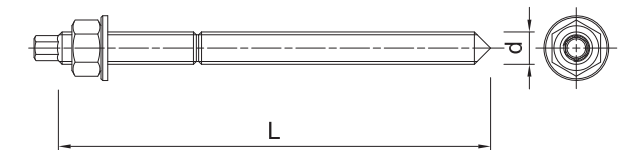

PRODUCT INFORMATION

Size	Product Code	Anchor		Fixture				
		Diameter	Length	Max. thickness t_{fix} for:		Hole diameter	Max. thickness t_{fix} for:	
		d [mm]	L [mm]	$h_{nom, 6d}$ [mm]	$h_{nom, 12d}$ [mm]	d_f [mm]	$h_{nom, min}$ [mm]	$h_{nom, 12d}$ [mm]
M8	R-STUDS-08110-HDG	8	110	52	4	9	40	4
M12	R-STUDS-12160-HDG	12	160	73	1	14	65	1
	R-STUDS-20220-HDG	20	220	77	-	22	77	-
M20	R-STUDS-20260-HDG	20	260	117	-	22	117	-
	R-STUDS-20270-HDG	20	270	127	7	22	127	7
M24	R-STUDS-24300-HDG	24	300	128	-	26	132	-

R-STUDS

METRIC THREADED RODS
- STEEL CLASS 5.8, HOT DIP GALVANIZED, FLAT HEAD

Threaded rod 5.8 grade steel, hot-dip galvanized (HDG) with increased corrosion resistance, for use with bonded anchors



FEATURES AND BENEFITS

- Threaded rod made of hot dip galvanized steel is suitable for outdoor use and in damp conditions
- High-performance bonded anchors offer high load-bearing capacities
- Suitable for use with special mesh sleeves in hollow substrates.
- Flat head for quick manual installation without a setting tool
- Can be post-installed through fixture in some cases. (Consult technical advisory service)
- Possibility of removal when used with internally threaded socket

APPLICATIONS

- Fastening with bonded anchors
- Supports
- Barriers
- Racking systems
- Consoles
- Railings
- Window elements
- Scaffolding
- Heavy machinery

INSTALLATION GUIDE

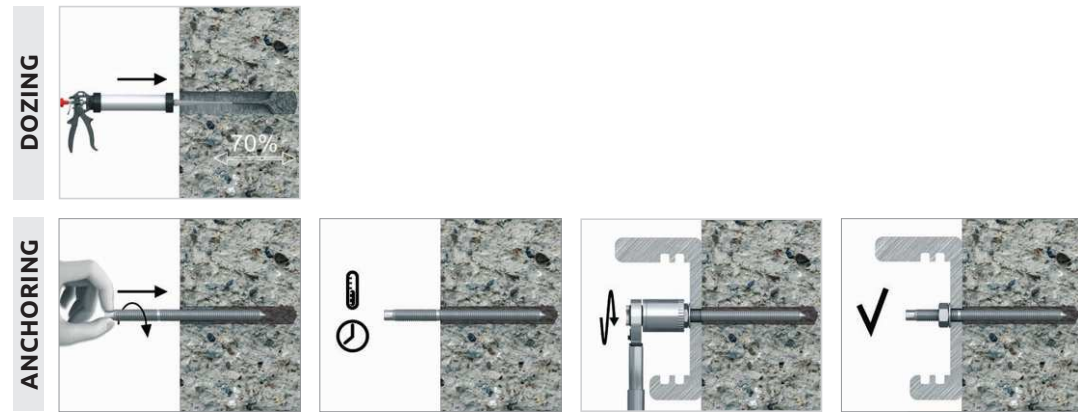

1. Drill hole to the required diameter and depth for stud size being used.
2. Clean the hole thoroughly with hand pump and hole brush
3. If required, insert the mesh sleeve into position
4. Fill hole with the required resin to the recommended fill level. (Follow the relevant instructions for the resin product)
5. Insert the threaded stud slowly and with a slight twisting motion, until the required embedment depth is reached
6. Leave undisturbed until curing time of resin has elapsed
7. Attach fixture and tighten the nut to the required installation torque

PRODUCT INFORMATION

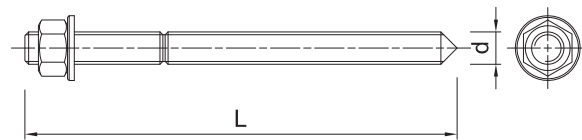

Size	Product Code	Anchor		Fixture				
		Diameter	Length	Max. thickness t_{fix} for:		Hole diameter	Max. thickness t_{fix} for:	
		d [mm]	L [mm]	$h_{nom, 6d}$ [mm]	$h_{nom, 12d}$ [mm]	d_f [mm]	$h_{nom, min}$ [mm]	$h_{nom, 12d}$ [mm]
M12	R-STUDS-12150-HDFL	12	150	63	-	14	55	-
	R-STUDS-16190-HDFL	16	190	75	-	18	71	-
	R-STUDS-16240-HDFL	16	240	125	29	18	121	29
M16	R-STUDS-16270-HDFL	16	270	155	59	18	151	59
	R-STUDS-16290-HDFL	16	290	175	79	18	171	79
	R-STUDS-16320-HDFL	16	320	205	109	18	201	108
	R-STUDS-16370-HDFL	16	370	255	159	18	251	159
M20	R-STUDS-20260-HDFL	20	260	117	-	22	117	-
	R-STUDS-20300-HDFL	20	300	157	37	22	157	37

R-STUDS

METRIC THREADED RODS
- STEEL CLASS 5.8, ZINC FLAKE

Threaded rod 5.8 grade steel, zinc flake (ZF) with increased corrosion resistance, for use with bonded anchors



FEATURES AND BENEFITS

- Hexagonal head for convenient use with torque wrench
- Special zinc flake corrosion-resistant coating
- Can be post-installed through fixture in some cases. (Consult technical advisory service)

APPLICATIONS

- Fastening with bonded anchors
- Balustrading & handrails
- Barriers
- Cable trays
- Consoles
- Curtain walling
- Formwork support systems
- Heavy machinery
- Lamps
- Safety barriers
- Road Signs
- Railings
- Public seating

INSTALLATION GUIDE

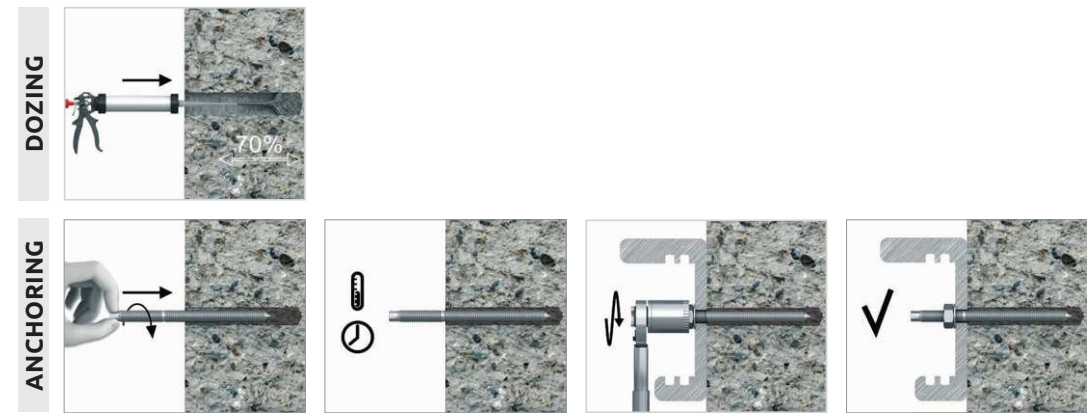

1. Drill hole to the required diameter and depth for stud size being used.
2. Clean the hole thoroughly with hand pump and hole brush
3. If required, insert the mesh sleeve into position
4. Fill hole with the required resin to the recommended fill level. (Follow the relevant instructions for the resin product)
5. Insert the threaded stud slowly and with a slight twisting motion, until the required embedment depth is reached
6. Leave undisturbed until curing time of resin has elapsed
7. Attach fixture and tighten the nut to the required installation torque

PRODUCT INFORMATION

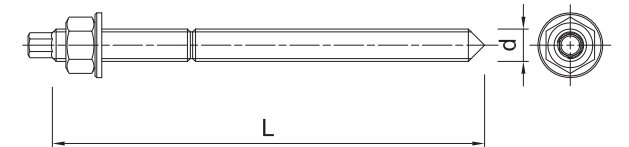

Size	Product Code	Anchor		Fixture				
		Diameter	Length	Max. thickness t_{fix} for:		Hole diameter	Max. thickness t_{fix} for:	
		d [mm]	L [mm]	$h_{nom, 6d}$ [mm]	$h_{nom, 12d}$ [mm]	d_f [mm]	$h_{nom, min}$ [mm]	$h_{nom, 12d}$ [mm]
M10	R-STUDS-10130-ZF	10	130	58	-	12	48	-
M12	R-STUDS-12160-ZF	12	160	73	1	14	65	1

R-STUDS METRIC THREADED RODS - STEEL CLASS 5.8, ZINC FLAKE, FLAT HEAD

Threaded rod 5.8 grade steel, zinc flake (ZF) with increased corrosion resistance, for use with bonded anchors



FEATURES AND BENEFITS

- Special zinc flake corrosion-resistant coating
- Can be post-installed through fixture in some cases. (Consult technical advisory service)

APPLICATIONS

- Fastening with bonded anchors
- Balustrading & handrails
- Barriers
- Cable trays
- Consoles
- Curtain walling
- Formwork support systems
- Heavy machinery
- Lamps
- Safety barriers
- Road Signs
- Railings
- Public seating

INSTALLATION GUIDE

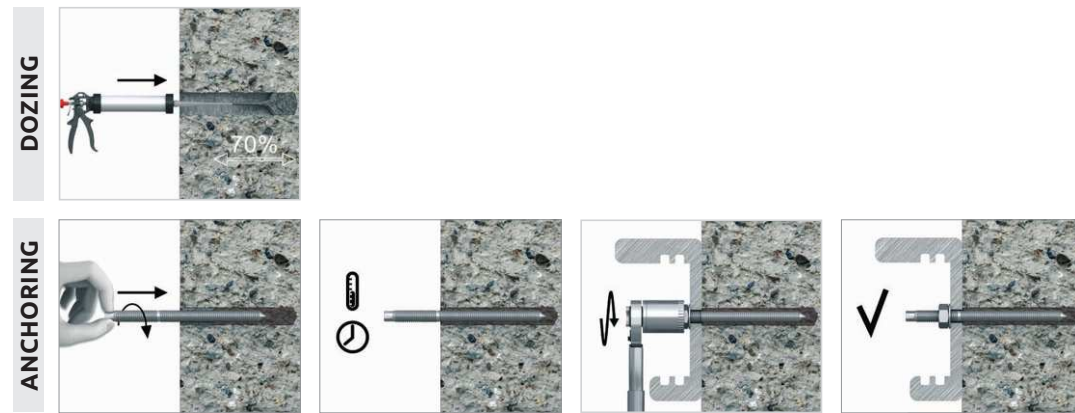

1. Drill hole to the required diameter and depth for stud size being used.
2. Clean the hole thoroughly with hand pump and hole brush
3. If required, insert the mesh sleeve into position
4. Fill hole with the required resin to the recommended fill level. (Follow the relevant instructions for the resin product)
5. Insert the threaded stud slowly and with a slight twisting motion, until the required embedment depth is reached
6. Leave undisturbed until curing time of resin has elapsed
7. Attach fixture and tighten the nut to the required installation torque

PRODUCT INFORMATION

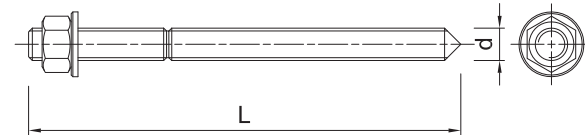

Size	Product Code	Anchor		Fixture				
		Diameter	Length	Max. thickness t_{fix} for:		Hole diameter	Max. thickness t_{fix} for:	
		d [mm]	L [mm]	$h_{nom,6d}$ [mm]	$h_{nom,12d}$ [mm]	d_f [mm]	$h_{nom,min}$ [mm]	$h_{nom,12d}$ [mm]
M8	R-STUDS-08110FL-ZF	8	110	52	4	9	40	4
M10	R-STUDS-10130FL-ZF	10	130	58	-	12	58	-
	R-STUDS-10170FL-ZF	10	170	98	38	12	88	38
M12	R-STUDS-12110FL-ZF	12	110	23	-	14	15	-
	R-STUDS-12160FL-ZF	12	160	73	1	14	65	1
	R-STUDS-12450FL-ZF	12	450	363	291	14	355	291
M16	R-STUDS-16190FL-ZF	16	190	75	-	18	71	-
M24	R-STUDS-24300FL-ZF	24	300	128	-	26	132	-

R-ITS-A4 INTERNALLY THREADED SOCKETS STAINLESS STEEL

Internally threaded socket for the attachment of suitable bolt or threaded rod. ETA Approved with pure epoxy resin



FEATURES AND BENEFITS

- Allows removal of bolt to leave a re-usable socket in place
- High load-bearing capacity
- Close edge and spacing distances
- Expansion free functioning
- Available in zinc plated and stainless steel versions

APPLICATIONS

- For fastening bolts
- Safety barriers
- Temporary works/formworks support systems

BASE MATERIALS

- Approved for use in:
- Non-cracked concrete C20/25-C50/60

INSTALLATION GUIDE

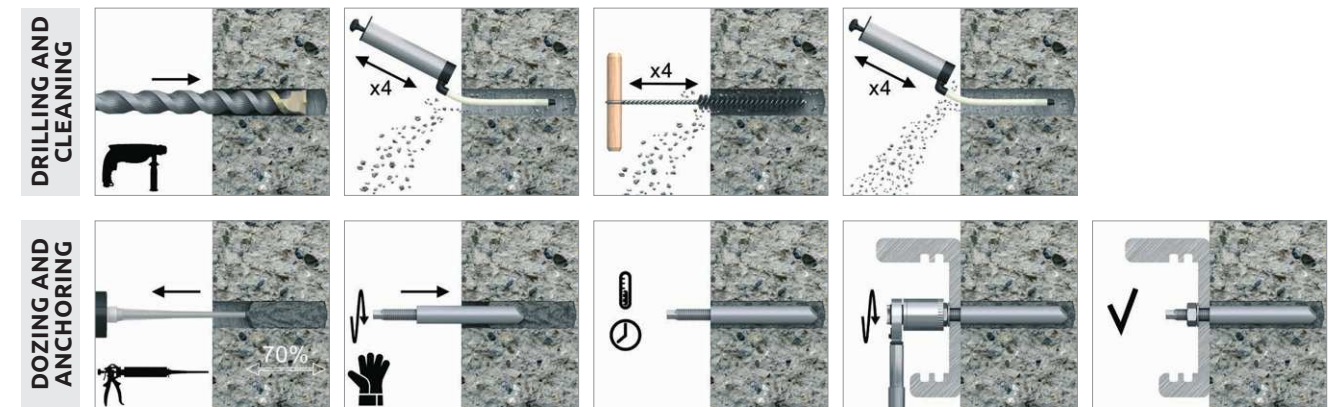

1. After injecting resin, immediately insert the socket anchor, slowly and with a slight twisting motion until flush with surface
2. Remove excess resin, then leave anchorage undisturbed until curing time has elapsed
3. Fill hole with the required resin to the recommended fill level. (Follow the relevant instructions for the resin product)
4. Attach fixture and tighten the nut to the required torque.

PRODUCT INFORMATION

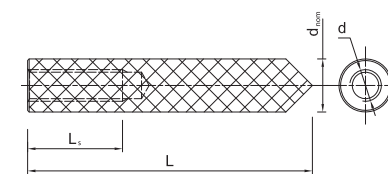

Size	Product Code	Anchor			Fixture	
		Socket diameter	Length	Internal thread length	Max. thickness t_{fix} for:	Hole diameter
		d [mm]	L [mm]	l_s [mm]	$h_{nom,std}$ [mm]	d_f [mm]
M6	R-ITS-A4-06075	10	75	24	-	7
M8	R-ITS-A4-08075	12	75	25	-	9
	R-ITS-A4-08090	12	90	25	-	9
M10	R-ITS-A4-10075	16	75	30	-	12
	R-ITS-A4-10100	16	100	30	-	12
M12	R-ITS-A4-12100	16	100	35	-	14
M16	R-ITS-A4-16125	24	125	50	-	18

R-ITS-Z INTERNALLY THREADED SOCKETS

High load-bearing capacity



FEATURES AND BENEFITS

- Allows removal of bolt to leave a re-usable socket in place
- High load-bearing capacity
- Close edge and spacing distances
- Expansion free functioning
- Available in zinc plated and stainless steel versions

APPLICATIONS

- For fastening bolts
- Safety barriers
- Temporary works/formworks support systems

BASE MATERIALS

- Approved for use in:
- Non-cracked concrete C20/25-C50/60

INSTALLATION GUIDE

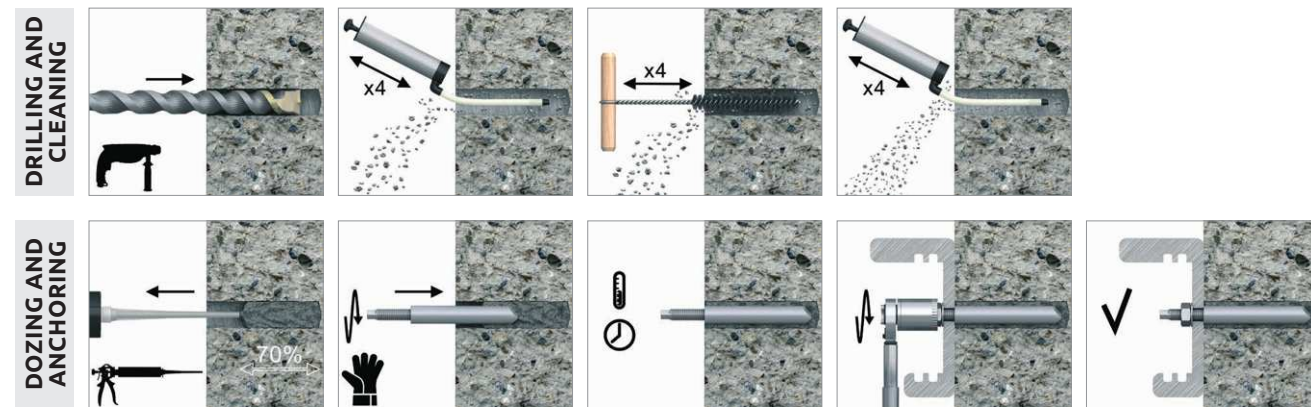

- After injecting resin, immediately insert the socket anchor, slowly and with a slight twisting motion until flush with surface
- Remove excess resin, then leave anchorage undisturbed until curing time has elapsed
- Fill hole with the required resin to the recommended fill level. (Follow the relevant instructions for the resin product)
- Attach fixture and tighten the nut to the required torque.

PRODUCT INFORMATION

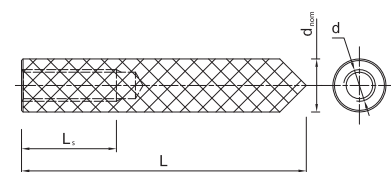

Size	Product Code	Anchor			Fixture	
		Socket diameter	Length	Internal thread length	Max. thickness t_{fx} for:	Hole diameter
		d [mm]	L [mm]	l_t [mm]	$h_{nom, std}$ [mm]	d_f [mm]
M6	R-ITS-Z-06075	10	75	24	-	7
M8	R-ITS-Z-08075	12	75	25	-	9
	R-ITS-Z-08090	12	90	25	-	9
M10	R-ITS-Z-10075	16	75	30	-	12
	R-ITS-Z-10100	16	100	30	-	12
M12	R-ITS-Z-12100	16	100	35	-	14
M16	R-ITS-Z-16125	24	125	50	-	18

R-NOZ MIXER NOZZLE

Static mixer for bonded anchors in cartridges and CFS+ system

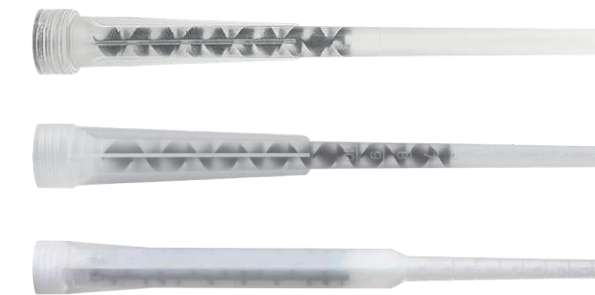

R-NOZ

R-NOZ-KER-II

R-NOZ-KEX-II

FEATURES AND BENEFITS

- Convenient extrusion and mixing of resin and hardener
- Available with or without hanger
- Ideal for serial applications: rebar or anchoring
- Specially dedicated nozzle fits for anchoring systems R-KEM II, R-KER, R-CFS+
- Possibility of extension- attach SP-CE-ED-1m extension nozzle

APPLICATIONS

- For use in a wide range of fastening applications in concrete and solid masonry structures

INSTALLATION GUIDE



- Simply screw the mixer nozzle onto the resin cartridge (after removing cap) or CFS+ system
- Before inserting nozzle to the hole inject resin until even colour is obtained
- Insert mixing nozzle to the far end the hole and inject resin, slowly withdrawing the nozzle

PRODUCT INFORMATION

Product Code	Length		Diameter	
	L			D
	[mm]	-		[mm]
R-NOZ-10	200	10 element Mixer Nozzle	-	
R-NOZ-100/100	200	10 element Mixer Nozzle	-	
R-NOZ-EXT-200	200	Extension for mixer nozzle R-NOZ	9.5	
R-NOZ-EXT-300	300	Extension for mixer nozzle R-NOZ	9.5	
R-NOZ-EXT-3000	3000	Extension for mixer nozzle R-NOZ	12	
SP-CE-ED-1M	1000	Extension for mixer nozzle R-NOZ	12	

R-PLS PLASTIC MESH SLEEVES

The sleeve for reduced mortar consumption and optimal mechanical interlock

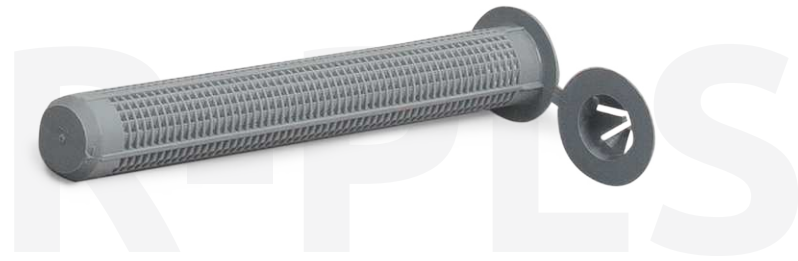

FEATURES AND BENEFITS

- Ensures that the anchor rod is properly centred.
- Reduces consumption of resin
- User-friendly installation in hollow substrates
- Size must be adjusted to the hole depth and diameter
- Hole cleaning is not necessary

APPLICATIONS

- For use with R-STUDS threaded rods in hollow base materials

INSTALLATION GUIDE

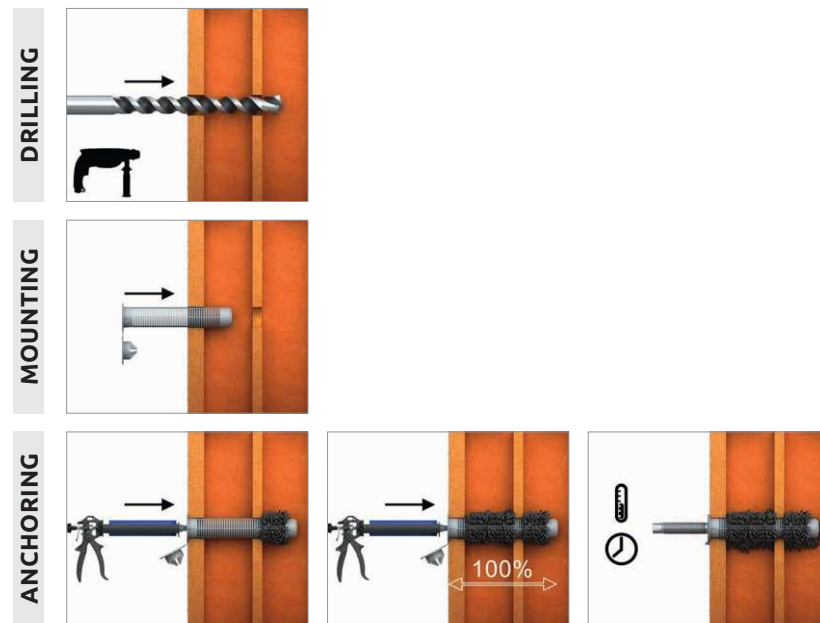

- Drill the hole and clean it up.
- Insert the sleeve in the hole.
- Apply the resin in 100 % of depth of the hole and close the cap.
- Place the stud in the sleeve and wait until full curing of the resin, as stated on the product label.
- After full curing of the anchor, install the fixed element with proper torque.

PRODUCT INFORMATION

Size	Product Code	Plastic mesh sleeve size	Stud size	Raw material	Colour
		d x l [mm]			
Ø 12	R-PLS-12050-10	12x50	M8	polypropylene	transparent
Ø 16	R-PLS-16085-10	16x85	M10-M12	polypropylene	transparent
	R-PLS-16130-10	16x130	M10-M12	polypropylene	transparent
Ø 20	R-PLS-20085-10	20x85	M16	polypropylene	transparent

SP-CE WIRE MESH SLEEVES

Metal, zinc-plated mesh sleeve for use with bonded anchors in hollow substrates and concrete

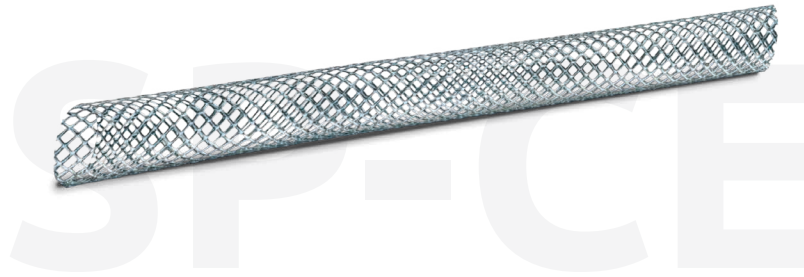

FEATURES AND BENEFITS

- Reduces consumption of resin and holds threaded rod in position
- Optimal mechanical interlock
- Dedicated for deep anchorage
- Necessary for use in copy-eco system - reinforcement of suspension rod in large-panel construction systems

APPLICATIONS

- For use with R-STUDS threaded rods in hollow base materials

INSTALLATION GUIDE

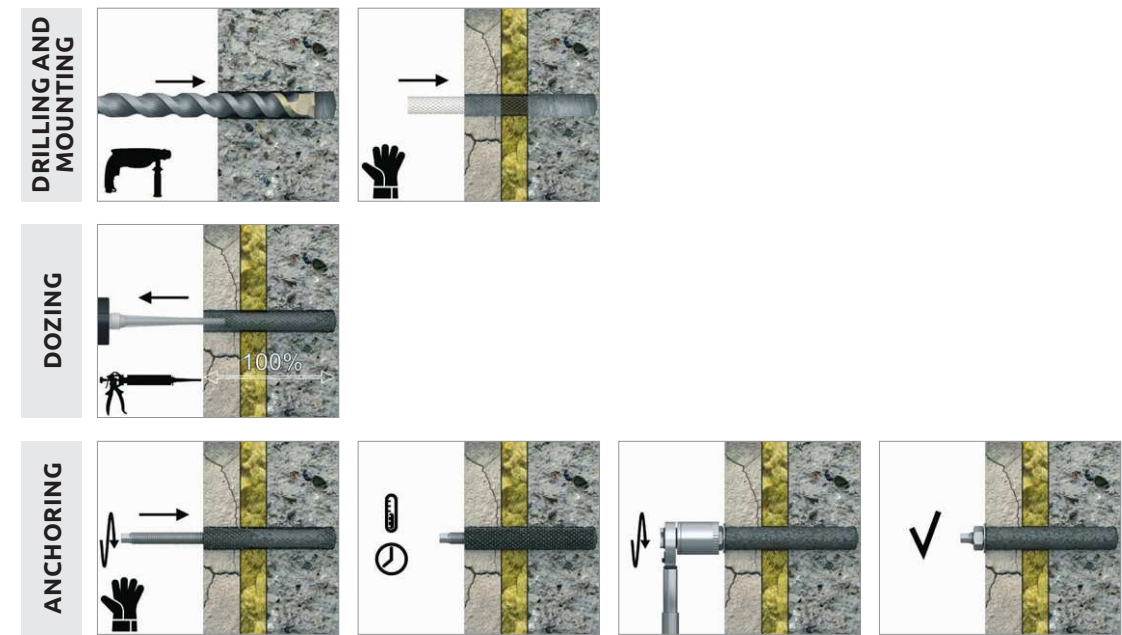

- Drill the hole and clear it with steps proper for the used substrate.
- Insert the mesh into pre-drilled hole, inject the resin and apply the stud.
- Apply the curing time given on the label of bonded anchor.
- After full curing of the resin complete the installation using torque indicated in proper ETA assesment.

PRODUCT INFORMATION

Size	Product Code	Diameter	Hole diameter	Length	Stud size
		d [mm]	d, [mm]	L [mm]	
Ø 12	SP-CE-R08	10	12	1000	M8
Ø 14	SP-CE-R10	12	14	1000	M8-M10
Ø 16	SP-CE-R12	14	16	1000	M12
Ø 20	SP-CE-R16	20	22	1000	M16
Ø 24	SP-CE-R20	26	28	1000	M20

R-NOZ-P FOR AUTOMATIC CLEANING SYSTEM

System for automatic cleaning deep holes before installing the anchor in a solid substrate



FEATURES AND BENEFITS

- Full control over the degree to which the hole is filled with resin
- Uniform resin injection into the hole
- Absence of air bubbles in the hole.
- Dispensing of the appropriate volume of the resin.

APPLICATIONS

- For use in a wide range of fastening applications in concrete and solid masonry structures
- Extending existing buildings and structures.
- Rebar dowelling
- Drilling holes in concrete, brick and stone
- Copy-eco systems
- Rebar missed-outs
- Rebar
- Post-installed rebar connections
- Formwork installation
- Shear dowel connections
- Renovation and modernization of bridges, buildings.

INSTALLATION GUIDE



1. Prepare the resin for the application.
2. Cut the PISTON PLUG with the required hole diameter.
3. Insert the hose with piston plug into the bottom hole.
4. Discard about 10 cm of unmixed resin, then connect the other end of the hose to the resin mixer.
5. Start dispensing the resin: the resin being injected will now be pushing the plug out of the hole (like a piston)

PRODUCT INFORMATION

Product Code	Suitable for	Drill diameter
	[mm]	[mm]
R-NOZ-P-16-26	Piston Plug dosing	16-26
R-NOZ-P-28-50	Piston Plug dosing	28-50
R-NOZ-P-SET	Piston Plug dosing	16-50

R-NOZ-ADAPTER AIR ADAPTER

Air Adapter R-NOZ-ADAPTER



FEATURES AND BENEFITS

- Thanks to the use of a compressor speed up work.
- Ideal for serial cleaning of deep holes.
- Enables precise cleaning of holes - especially in deep anchoring.
- Uniform removes dust and dust from the hole.

INSTALLATION GUIDE

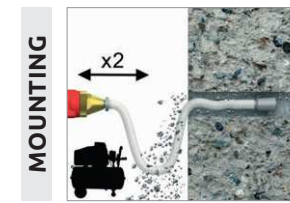

1. Select the right air adapter to the required hole size.
2. Connected adapter to the flexible hose insert in the hole, reaching the bottom.
3. The other end of the flexible hose connect to the compressor and start cleaning the hole with dust.
4. Clean the hole with compressed air starting from the drill hole bottom, blow the hole at least twice by compressed air minimum 6 bar.

PRODUCT INFORMATION

Product Code	Description	Size
		[mm]
R-NOZ-ADAPTER-14	Air adapter	14 - 20
R-NOZ-ADAPTER-22	Air adapter	22 - 26
R-NOZ-ADAPTER-28	Air adapter	28 - 50

APPLICATIONS

- For use in a wide range of fastening applications in concrete and solid masonry structures
- Drilling holes in concrete, brick and stone
- Rebar missed-outs
- Formwork installation
- Shear dowel connections
- Renovation and modernization of bridges, buildings.
- Securing formwork

BASE MATERIALS

- Approved for use in:
- Non-cracked concrete C12/15-C50/60

R-GUN DISPENSER GUN 175 - 310 ML, 345 ML

Professional dispensing system for resin anchors in cartridges

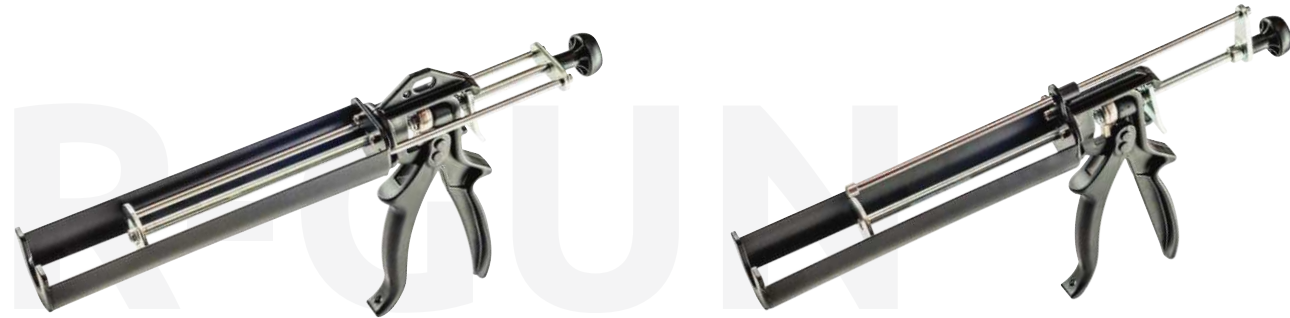

R-GUN-300-N

FEATURES AND BENEFITS

- Fast and effortless resin injection
- Convenient dispensing tool for a range of situations
- Type of gun used for anchoring strictly depends on the type of cartridge
- Robust design for all jobsite conditions

R-GUN-345-N

APPLICATIONS

- Dispenser gun suitable for 175ml, 280ml, 300ml, 310ml, 345ml cartridges
- Manual operation - no need for external power supply
- For use in a wide range of fastening applications in concrete and solid masonry structures

INSTALLATION GUIDE



1. Open the cartridge and attach the proper nozzle.
2. Put the cartridge into the gun thoroughly.
3. Make sure that the nozzle is in correct position and lies in the fence.
4. By pressing the trigger dose the required amount of the product.
5. After finished work empty the gun and clean if necessary.

PRODUCT INFORMATION

Product Code	Description	Suitable for
R-GUN-300-N	300 ml CARTRIDGE GUN	Cartridges 175 ml, 280 ml, 300ml, 310ml R-KEM+, R-KEM-II, R-KER, R-KER-II
R-GUN-345-N	345 ml CARTRIDGE GUN	R-KER-345, R-KER-II-345

PRODUCT COMMERCIAL DATA

Product Code	Description	Quantity [pcs]			Weight [kg]			Bar Codes
		Box	Outer	Pallet	Box	Outer	Pallet	
R-GUN-300-N	300 ml CARTRIDGE GUN	1	12	360	1.00	12.0	388.9	5906675280141
R-GUN-345-N	345 ml CARTRIDGE GUN	12	12	300	12.0	12.0	329.1	5906675280158

R-GUN DISPENSER GUN FOR 380-410ML CARTRIDGES

Professional dispensing system for resin anchors in cartridges



FEATURES AND BENEFITS

- Manual operation - no need for external power supply
- Type of gun used for anchoring strictly depends on the type of cartridge
- Fast and effortless resin injection
- Convenient dispensing tool for a range of situations
- Robust design for all jobsite conditions

APPLICATIONS

- Dosing of bonded resins and other mediums from coaxial 380 -410 ml cartridges.
- Manual operation - no need for external power supply
- For use in a wide range of fastening applications in concrete and solid masonry structures

INSTALLATION GUIDE



1. Open the cartridge and attach the proper nozzle.
2. Put the cartridge into the gun thoroughly.
3. Make sure that the nozzle is in correct position and lies in the fence.
4. By pressing the trigger dose the required amount of the product.
5. After finished work empty the gun and clean if necessary.

PRODUCT INFORMATION

Product Code	Description	Suitable for
R-GUN-380-P	380 ml CARTRIDGE GUN	R-KEM-II-380,410, R-KF2-380,400, R-KER-II-400, R-KER-380, R-KER-400

R-GUN-MULTI MANUAL DISPENSER FOR BONDED ANCHORS IN CARTRIDGES

Professional dispensing system for resin anchors in cartridges



FEATURES AND BENEFITS

- Fast and effortless resin injection
- Manual operation - no need for external power supply
- Convenient dispensing tool for a range of situations
- Robust design for all jobsite conditions
- One dispenser for all types of cartridges

APPLICATIONS

- Dosing of bonded resins and other mediums from coaxial 380-410 ml cartridges.
- Manual operation - no need for external power supply
- For use in a wide range of fastening applications in concrete and solid masonry structures

BASE MATERIALS

- Approved for use in:
- Cracked Concrete
 - Non-cracked Concrete
 - Ceramics
 - Solid Brick
 - Silicate Blocks
 - Solid Concrete Block

INSTALLATION GUIDE



1. Open the cartridge and attach the proper nozzle.
2. Put the cartridge into the gun thoroughly.
3. Make sure that the nozzle is in correct position and lies in the fence.
4. By pressing the trigger dose the required amount of the product.
5. After finished work empty the gun and clean if necessary.

PRODUCT INFORMATION

Product Code	Description	Suitable for
R-GUN-MULTI	Universal cartridge dispenser	For R-KEX, R-KER-II, R-KER, R-KEM-II in 300, 380-410ml coaxial, 385, 600ml side by side cartridges

R-GUN DISPENSER GUN 600 ML

Professional dispensing system for resin anchors in cartridges



FEATURES AND BENEFITS

- Manual operation - no need for external power supply
- Type of gun used for anchoring strictly depends on the type of cartridge
- Fast and effortless resin injection
- Convenient dispensing tool for a range of situations
- Robust design for all jobsite conditions
- Gun dedicated for side-by-side cartridges of 600, 385 ml

APPLICATIONS

- Manual operation - no need for external power supply
- Pneumatic gun ideal for serial application
- For use in a wide range of fastening applications in concrete and solid masonry structures

BASE MATERIALS

- Approved for use in:
- Cracked Concrete
 - Non-cracked Concrete
 - Solid Brick
 - Solid Concrete Block
 - Solid Sand-lime Brick
 - Hollow Brick
 - Hollow Lightweight Concrete Block
 - Hollow Sand-lime Brick
 - Hollow-core Slab

INSTALLATION GUIDE



1. Open the cartridge and attach the proper nozzle.
2. Put the cartridge into the gun thoroughly.
3. Make sure that the nozzle is in correct position and lies in the fence.
4. By pressing the trigger dose the required amount of the product.
5. After finished work empty the gun and clean if necessary.

PRODUCT INFORMATION

Product Code	Description	Suitable for
R-GUN-600-P	385, 600 ml CARTRIDGE GUN	R-KEX-II

R-GUN DISPENSER GUN CFS+

Professional dispensing system for bonded anchors in 300 ml foil loads



FEATURES AND BENEFITS

- Manual operation - no need for external power supply
- Type of gun used for anchoring strictly depends on the type of cartridge
- Fast and effortless resin injection
- Convenient dispensing tool for a range of situations
- Robust design for all jobsite conditions

APPLICATIONS

- Gun dedicated for 300 ml CFS+ system
- For use in a wide range of fastening applications in concrete and solid masonry structures

INSTALLATION GUIDE



- Drill hole to the required diameter and depth for threaded rods size being used.
- Clean the hole thoroughly with brush and hand pump at least four times before installation.
- Insert foil into gun and attach nozzle.
- Dispense to waste until even colour is obtained.
- Insert the mixer nozzle to the bottom of the drill hole and inject resin, slowly withdrawing the nozzle as the hole is filled to 70% of its depth.
- Immediately insert the rebar, slowly and with slight twisting motion. Remove any excess resin around the hole before it sets and leave it undisturbed until the curing time elapses.
- Attach fixture and tighten the nut to the required torque.

PRODUCT INFORMATION

Product Code	Description	Suitable for	Colour
R-CFS+-GUN	300 ml CFS+ GUN	RV200, RM50, RP30	-
R-CFS+GUN-600	600 ml CFS+ GUN	RV200, RM50, RP30	transparent

R-GUN PNEUMATIC DISPENSER GUN 380ML

Professional dispensing system for resin anchors in cartridges



FEATURES AND BENEFITS

- Type of gun used for anchoring strictly depends on the type of cartridge
- Fast and effortless resin injection
- Convenient dispensing tool for a range of situations
- Robust design for all jobsite conditions

APPLICATIONS

- Dosing of bonded resins and other mediums from coaxial 380 -410 ml cartridges.
- For use in a wide range of fastening applications in concrete and solid masonry structures
- Pneumatic gun ideal for serial application

INSTALLATION GUIDE



- Join the gun with the source of compressed air.
- Open the cartridge and attach the proper nozzle.
- Open the gun, press the cartridge into the gun and close it thoroughly.
- Make sure that the nozzle is in correct position and lies in the fence.
- By pressing the trigger dose the required amount of the product. Air flow might be adjusted by regulator in the back part of gun.
- After finished work empty the gun and clean if necessary.

PRODUCT INFORMATION

Product Code	Description	Suitable for	Box	Weight	Pneumatic system	Magnitude of force exerted by the applicator
			[pcs]	[kg]	[bar]	Magnitude of force exerted by the applicator [kN]
R-GUN-380-PNEU	380 ml Cartridge Pneumatic Gun	For 380ml coaxial cartridges only	1	1.81	6.8	2.2

R-GUN PNEUMATIC DISPENSER GUN CFS+

Professional dispensing system for resin anchors in foil packs



FEATURES AND BENEFITS

- Type of gun used for anchoring strictly depends on the type of cartridge
- Fast and effortless resin injection
- Convenient dispensing tool for a range of situations
- Robust design for all jobsite conditions

APPLICATIONS

- Pneumatic gun dedicated for 300/600 ml CFS+ system
- Pneumatic gun ideal for serial application
- For use in a wide range of fastening applications in concrete and solid masonry structures

BASE MATERIALS

- Approved for use in:
- Cracked Concrete
 - Non-cracked Concrete
 - Solid Brick
 - Solid Concrete Block
 - Solid Sand-lime Brick
 - Hollow Brick
 - Hollow Lightweight Concrete Block
 - Hollow Sand-lime Brick
 - Hollow-core Slab

INSTALLATION GUIDE



- Charge the battery and install it in the dispenser handle. Release the squeezing piston with the button and pull it backwards.
- Open the cartridge and attach the proper nozzle.
- Put the cartridge into the powered gun thoroughly.
- By pressing the trigger dose the required amount of the product. Dispense to waste until even colour is obtained (min. 10 cm).
- Resin dosaging can be performed in a manual or repetitive function. The setting is possible by selecting the manual or repate button
- After finished work empty the gun and clean if necessary.

PRODUCT INFORMATION

Product Code	Description	Suitable for
R-CFS+-GUN-PNEU	300/600 ml CARTRIDGE GUN	RV200, RM50, RP30

R-GUN DISPENSER GUN CFS+

Professional dispensing system for bonded anchors in 300 ml foil packs



FEATURES AND BENEFITS

- Manual operation - no need for external power supply
- Type of gun used for anchoring strictly depends on the type of cartridge
- Fast and effortless resin injection
- Convenient dispensing tool for a range of situations
- Robust design for all jobsite conditions

APPLICATIONS

- Gun dedicated for 300 ml CFS+ system
- For use in a wide range of fastening applications in concrete and solid masonry structures

INSTALLATION GUIDE



- Drill hole to the required diameter and depth for threaded rods size being used.
- Clean the hole thoroughly with brush and hand pump at least four times before installation.
- Insert foil into gun and attach nozzle.
- Dispense to waste until even colour is obtained.
- Insert the mixer nozzle to the bottom of the drill hole and inject resin, slowly withdrawing the nozzle as the hole is filled to 70% of its depth.
- Immediately insert the rebar, slowly and with slight twisting motion. Remove any excess resin around the hole before it sets and leave it undisturbed until the curing time elapses.
- Attach fixture and tighten the nut to the required torque.

PRODUCT INFORMATION

Product Code	Description	Suitable for	Colour
R-CFS+-GUN	300 ml CFS+ GUN	RV200, RM50, RP30	-
R-CFS+-GUN-600	600 ml CFS+ GUN	RV200, RM50, RP30	transparent
R-GUN-CFS+300-P	300 ml CFS+ GUN	RV200, RM50, RP30	transparent

R-GUN BATTERY DISPENSER GUN 380 ML

Professional dispensing system for resin anchors in cartridges



FEATURES AND BENEFITS

- Fast and effortless resin injection
- Wireless work thanks to a powerful battery.
- Light and ergonomic design.
- Controlled speed ensures controlled dosing.
- Safety switch in case of excessive overload prevents damage.
- Anti-drip function

APPLICATIONS

- Dosing of bonded resins and other mediums from coaxial 380 -410 ml cartridges.

INSTALLATION GUIDE



1. Charge the battery and install it in the dispenser handle. Release the squeezing piston with the button and pull it backwards.
2. Open the cartridge and attach the proper nozzle. Put the cartridge into the powered gun thoroughl
3. By pressing the trigger dose the required amount of the product. Dispense to waste until even colour is obtained (min. 10 cm).
4. Resin dosaging can be performed in a manual function

PRODUCT INFORMATION

Product Code	Suitable for	Magnitude of force exerted by the applicator [kN]	Voltage [V]	Battery capacity [Ah]	Charging time [h]
R-GUN-380-AKU-T	For 380ml (10:1 ratio) coaxial cartridges	6,86	18	2	0,5

R-GUN BATTERY EXTRUSION GUN WITH DOSING 380 ML

Memory function - enables precise dispensing of a repetitive amount of resin



FEATURES AND BENEFITS

- Quick and easy application of resins.
- Wireless work thanks to a powerful battery.
- Option of memorizing the dose.
- Regulation of the dosing speed.
- Anti-drip function
- Battery powered - high performance lithium-ion battery.
- Memory function - enables precise dispensing of a repetitive amount of resin

APPLICATIONS

- Dosing of bonded resins and other mediums from coaxial 380 -410 ml cartridges.

INSTALLATION GUIDE



1. Charge the battery and install it in the dispenser handle. Release the squeezing piston with the button and pull it backwards.
2. Open the cartridge and attach the proper nozzle.
3. Put the cartridge into the powered gun thoroughly.
4. By pressing the trigger dose the required amount of the product. Dispense to waste until even colour is obtained (min. 10 cm).
5. Resin dosaging can be performed in a manual or repetitive function. The setting is possible by selecting the manual or repate button
6. After finished work empty the gun and clean if necessary.

PRODUCT INFORMATION

Product Code	Suitable for	Box	Weight	Magnitude of force exerted by the applicator	Voltage [V]	Range of temperatures for application	Battery capacity [Ah]	Performance	Charging time [min]	Dosing speed [mm/s]	Description
		[pcs]	[kg]	[kN]		[°C]					
R-GUN-380-AKU DOSE	For 380ml (10:1 ratio) coaxial cartridges	1	1.82	max 5	18	+5 - +40	2	up to 50 cartridges on 1 battery	100% - 65 min	4.5	-
RT-CGB-18V-DB2	R-GUN-380-AKU DOSE, R-GUN-KEX600AKUDOS	-	-	-	18	-	2	-	-	-	Li-ion Battery pack 2,0 Ah 18V

R-GUN BATTERY GUN WITH DOSING 600 ML FOR R-KEX-II

Professional dispensing system for resin anchors in cartridges



FEATURES AND BENEFITS

- Quick and easy application of resins.
- Wireless work thanks to a powerful battery.
- Option of memorizing the dose.
- Regulation of the dosing speed.
- Anti-drip function
- Battery powered - high performance lithium-ion battery.
- Memory function - enables precise dispensing of a repetitive amount of resin

APPLICATIONS

- Dosing of bonded resins in Side by Side cartridges 385 and 600ml R-KEX-II

INSTALLATION GUIDE



1. Charge the battery and install it in the dispenser handle. Release the squeezing piston with the button and pull it backwards.
2. Open the cartridge and attach the proper nozzle.
3. Put the cartridge into the powered gun thoroughly.
4. By pressing the trigger dose the required amount of the product. Dispense to waste until even colour is obtained (min. 10 cm).
5. Resin dosaging can be performed in a manual or repetitive function. The setting is possible by selecting the manual or repate button.
6. After finished work empty the gun and clean if necessary.

PRODUCT INFORMATION

Product Code	Suitable for	Box	Weight	Magnitude of force exerted by the applicator	Voltage	Range of temperatures for application	Battery capacity	Performance	Charging time	Dosing speed	Description
		[pcs]	[kg]	[kN]	[V]	[°C]	[Ah]	up to 50 cartridges on 1 battery	[min]	[mm/s]	
R-GUN-KEX600A-KUDOS	For 385 and 600 ml (3:1 ratio) side by side cartridges eg R-KEX-II-385, R-KEX-II-600	1	1.82	max 5	18	+5 - +40	2	up to 50 cartridges on 1 battery	100% - 65 min	4.5	-
RT-CGB-18V-DB2	R-GUN-380-AKUDOSE, R-GUN-KEX600AKUDOS	-	-	-	18	-	2	-	-	-	Li-ion Battery pack 2,0 Ah 18V

R-GUN ELECTRIC DISPENSER GUN CFS+

Professional dispensing system for resin anchors in foil packaging



FEATURES AND BENEFITS

- Fast and effortless resin injection
- Wireless work thanks to a powerful battery.
- Light and ergonomic design.
- Controlled speed ensures controlled dosing.
- Safety switch in case of excessive overload prevents damage.
- Anti-drip function

APPLICATIONS

- Gun dedicated for CFS+ system
- For use in a wide range of fastening applications in concrete and solid masonry structures

INSTALLATION GUIDE



1. Charge the battery and install it in the dispenser handle. Release the squeezing piston with the button and pull it backwards.
2. Open the cartridge and attach the proper nozzle. Put the cartridge into the powered gun thoroughl
3. By pressing the trigger dose the required amount of the product. Dispense to waste until even colour is obtained (min. 10 cm).
4. Resin dosaging can be performed in a manual function

PRODUCT INFORMATION

Product Code	Suitable for	Magnitude of force exerted by the applicator	Voltage	Battery capacity	Charging time
		[kN]	[V]	[Ah]	[h]
R-CFS-GUN-600-AKU	For 380ml (10:1 ratio) coaxial cartridges	max 2,5	10.8	1.5	0.5



Mechanical Anchors

	R-LX Countersunk screw anchors - structural fixings	222
	R-HPTIIA4 Stainless Steel Throughbolt	230
	R-HPTII-ZF Zinc Flake Throughbolt	235
	R-XPTII-A4 Stainless Steel Throughbolt	239
STRUCTURAL	R-XPTIII-HD Hot Dip Galvanized Throughbolt	242
	R-XPT Throughbolt	244
	R-RB Rawlbolt® for use in cracked and non-cracked concrete	247
	R-SPL Safety Plus	252
	R-DCA-A4 Stainless Steel Wedge Anchor	256
	R-DCA Wedge Anchor	258
	R-DCL Lipped Wedge Anchors	260
NON STRUCTURAL	R-LX Concrete screw anchors - multipoint structural fixings	263
	R-RB Rawlbolt® for use in hollow core slab and ceramic substrates	272

OVERVIEW OF OUR RANGE - MECHANICAL ANCHOR SELECTOR

MECHANICAL ANCHORS - OUR RANGE

THROUGHBOLTS

Throughbolt anchors designed for use in cracked and non-cracked concrete



SHIELD ANCHORS

World's most popular all-purpose expanding shield anchor for use in cracked and non-cracked concrete



HEAVY DUTY EXPANSION ANCHORS

Heavy duty expansion anchor, suitable for demanding safety-critical applications



FEATURES AND BENEFITS

- » High performance in cracked and non-cracked concrete confirmed by ETA Option 1 or ETA Option 7
 - » Stainless steel material for the highest corrosion resistance
 - » New generation of throughbolt with unique corrosion-resistant coating
 - » Throughbolts are suitable for reduced embedment to avoid contact with reinforcement
 - » Embedment depth markings help to ensure precise installation
 - » Design allows drilling and installation directly through the fixture and reduces overall installation effort
- » For use in cracked and non-cracked concrete (ETA option 1), hollow-core slabs, flooring blocks and ceramics
 - » Shield anchor (shield also available separately)
 - » Product recommended for applications requiring fire resistance
 - » Bolt lengths suitable for fixture thicknesses of up to 150 mm
 - » Ferrule marked with hole diameter to ensure correct installation
 - » Optimum geometry for maximum expansion in all recommended substrates
 - » Excellent tolerance to variation in hole size
- » Mechanical anchor for highest tension and shear loads
 - » For usage with required fire resistance
 - » Option 7 ETA for Non-Cracked Concrete

ANCHOR PRODUCTS AVAILABLE:

R-HPTIIA4, R-HPTIIF, R-XPTIIA4, R-XPT, R-XPTIII-HD RAWLBOLT: R-RBL, R-RBP, R-RB-PF, R-RBL-E, R-RBL-H, R-RB SAFETY PLUS: R-SPL, R-SPL-BP, R-SPL-C

WEDGE ANCHORS

Internally threaded wedge anchors for simple hammer-set installation



SCREW ANCHORS

Self-tapping and removable concrete screw anchor for through-fixing installation



FEATURES AND BENEFITS

- » High performance in cracked and non-cracked concrete confirmed by ETA
 - » Product recommended for applications requiring fire resistance
 - » Internally threaded to be used with threaded studs, rods or bolts
 - » Easy to install by hammer action
 - » Slotted sleeve and internal wedge component together facilitate easy setting and expansion
 - » Allows bolts or studs to be installed or removed without damaging the anchorage
- » Time-efficient installation through streamlined procedure - simply drill and drive
 - » Completely removable, allows repeatable use
 - » Unique design with patented threadform ensures high performance for relatively small hole diameter
 - » Integral washer ensures a neat overall appearance
 - » Non-expansion functioning ensures low risk of damage to base material and makes R-LX ideal for installation near edges and adjacent anchors
 - » Performance data at two embedment depths (reduced embedment to avoid contact with reinforcement)

ANCHOR PRODUCTS AVAILABLE:

R-DCA, R-DCL, R-DCA-A4 R-LX-HF-ZP, R-LX-H-ZP, R-LX-CS-ZP, R-LX-HF-ZF, R-LX-H-ZF, R-LX-CS-ZF,

MECHANICAL ANCHORS - DESIGN SOFTWARE



CONCRETE MODULE

The filters and optimisation functions make it possible to choose the right type and size of fixing in a simple and quick way.

The module also makes it possible to calculate the required thickness of the slab.

A wide range of options for placing the fasteners on the element to be fixed is available. Option of using the original REDM (Rawlplug Engineering Design Method) based on the many years of experience of RAWLPLUG's engineers and on European guidelines. This makes it possible to design more complex anchoring systems.

Possibility of entering design loads, characteristic loads with region-specific safety factors, seismic and fire loads.

Possibility of designing according to different calculation standards, US and European ones (e.g. EN, ETAG, ACI) and Rawlplug's original method. This allows the calculations to be adjusted to the needs and legal requirements of all global markets. Australian and Russian standards are planned to be included in the program.



BALUSTRADE MODULE

Makes it possible to design fixings intended for concrete substrates.

Includes diagrams that match the systems used when installing safety barriers.

The module makes use of a simplified model for entering load parameters.

They are assumed on the basis of the guidelines laid down in the EN 1991-1-1 standard which recommends the range of characteristic loads for different use categories.

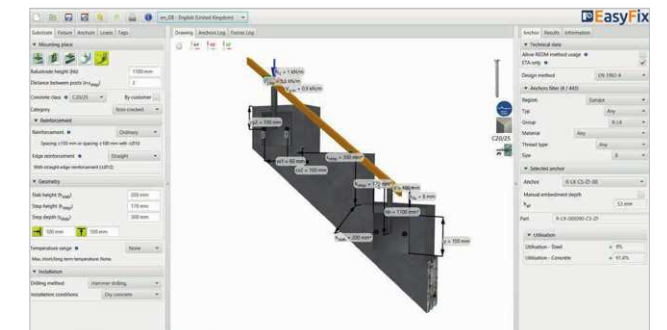

R-LX CONCRETE SCREW ANCHORS
- STRUCTURAL FIXINGS

Self-tapping concrete screwbolt



Hexagonal head screw with washer
R-LX-HF



Countersunk head screw
R-LX-CS



Internally threaded head screw
R-LX-I



Externally threaded head screw
R-LX-E



Panhead XL screw
R-LX-PX-ZP



Hexagonal head screw for temporary installation
R-LX-H*

*not included in the approval



FEATURES AND BENEFITS

- Time-efficient installation through streamlined procedure - simply drill and drive
- Completely removable with possibility of reuse
- Unique design with patented threadform ensures high performance for relatively small hole diameter
- Non-expansion functioning ensures low risk of damage to base material and makes R-LX ideal for installation near edges and adjacent anchors
- Special zinc flake corrosion-resistant coating
- High performance in both uncracked and cracked concrete
- Different head types for any application
- Oversize head for fixtures with elongated holes
- Excellent product for temporary fixing
- Suitable for standard and reduced embedment depth

APPLICATIONS

- Through-fixing
- Temporary anchorages
- Formwork support systems
- Balustrading & handrails
- Fencing & gates manufacturing and installation
- Racking systems
- Public seating
- Scaffolding

BASE MATERIALS

- Approved for use in:
- Cracked concrete C20/25-C50/60
 - Non-cracked concrete C20/25-C50/60
 - Reinforced concrete
 - Unreinforced concrete
- Also suitable for use in:
- Natural Stone (after site testing)

R-LX CONCRETE SCREW ANCHORS
- STRUCTURAL FIXINGS

INSTALLATION GUIDE



1. Drill the hole with rotary percussive machine. Drill to a required depth.
2. Blow out dust at least 4 times with a hand pump.

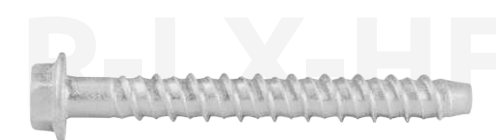

3. Possibility of unscrewing and re-screwing
4. Tighten to the recommended torque
5. After installation.

R-LX CONCRETE SCREW ANCHORS - STRUCTURAL FIXINGS

PRODUCT INFORMATION

R-LX-HF HEXAGONAL HEAD SCREW WITH WASHER

	Product Code		Drill	Anchor		Fixture		Hole diameter d _f [mm]
				Diameter	Length	Max. thickness t _{fix} for:		
				d [mm]	L [mm]	h _{nom,std} [mm]	h _{nom,red} [mm]	
	R-LX-HF-ZF	R-LX-HF-ZP						
5	-	R-LX-05X035-HF-ZP		6.3	35	-	-	7
	R-LX-05X050-HF-ZF	R-LX-05X050-HF-ZP	5	6.3	50	7	-	7
	R-LX-05X075-HF-ZF	R-LX-05X075-HF-ZP	5	6.3	75	32	-	7
6	R-LX-06X050-HF-ZF	R-LX-06X050-HF-ZP	6	7.5	50	-	7	9
	-	R-LX-06X060-HF-ZP	6	7.5	60	5	17	9
	R-LX-06X075-HF-ZF	R-LX-06X075-HF-ZP	6	7.5	75	20	32	9
	-	R-LX-06X090-HF-ZP	6	7.5	90	35	47	9
	R-LX-06X100-HF-ZF	R-LX-06X100-HF-ZP	6	7.5	100	45	57	9
	R-LX-06X130-HF-ZF	R-LX-06X130-HF-ZP	6	7.5	130	75	87	9
8	R-LX-08X060-HF-ZF	R-LX-08X060-HF-ZP	8	10	60	-	10	12
	R-LX-08X075-HF-ZF	R-LX-08X075-HF-ZP	8	10	75	5	30	12
	R-LX-08X090-HF-ZF	R-LX-08X090-HF-ZP	8	10	90	20	40	12
	R-LX-08X100-HF-ZF	R-LX-08X100-HF-ZP	8	10	100	30	50	12
	-	R-LX-08X120-HF-ZP	8	10	120	50	70	12
	R-LX-08X130-HF-ZF	R-LX-08X130-HF-ZP	8	10	130	60	80	12
10	R-LX-10X085-HF-ZF	R-LX-10X085-HF-ZP	10	12.5	85	-	30	14
	-	R-LX-10X090-HF-ZP	10	12.5	90	5	35	14
	R-LX-10X100-HF-ZF	R-LX-10X100-HF-ZP	10	12.5	100	15	45	14
	-	R-LX-10X110-HF-ZP	10	12.5	110	25	55	14
	R-LX-10X120-HF-ZF	R-LX-10X120-HF-ZP	10	12.5	120	35	65	14
	-	R-LX-10X130-HF-ZP	10	12.5	130	45	75	14
	R-LX-10X140-HF-ZF	R-LX-10X140-HF-ZP	10	12.5	140	55	85	14
	-	R-LX-10X150-HF-ZP	10	12.5	150	65	95	14
	R-LX-12X075-HF-ZF	R-LX-12X075-HF-ZP	12	14	75	-	10	16
	R-LX-12X100-HF-ZF	R-LX-12X100-HF-ZP	12	14	100	-	35	16
12	R-LX-12X130-HF-ZF	R-LX-12X130-HF-ZP	12	14	130	30	65	16
	R-LX-12X150-HF-ZF	R-LX-12X150-HF-ZP	12	14	150	50	85	16
	R-LX-14X080-HF-ZF	R-LX-14X080-HF-ZP	14	17	80	-	5	18
14	R-LX-14X105-HF-ZF	R-LX-14X105-HF-ZP	14	17	105	-	30	18
	R-LX-14X115-HF-ZF	R-LX-14X115-HF-ZP	14	17	115	-	40	18
	R-LX-14X135-HF-ZF	R-LX-14X135-HF-ZP	14	17	135	15	60	18
	-	R-LX-14X160-HF-ZP	14	17	160	40	85	18

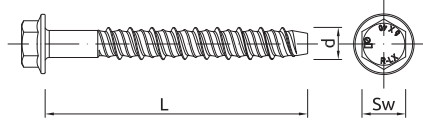

R-LX-CS COUNTERSUNK HEAD SCREW

	Product Code		Drill	Anchor		Fixture		Hole diameter d _f [mm]
				Diameter	Length	Max. thickness t _{fix} for:		
				d [mm]	L [mm]	h _{nom,std} [mm]	h _{nom,red} [mm]	
	R-LX-CS-ZF	R-LX-CS-ZP						
5	R-LX-05X050-CS-ZF	R-LX-05X050-CS-ZP	5	6.3	50	7	-	7
	R-LX-05X075-CS-ZF	R-LX-05X075-CS-ZP	5	6.3	75	32	-	7
	R-LX-06X050-CS-ZF	R-LX-06X050-CS-ZP	6	7.5	50	-	7	9
6	-	R-LX-06X060-CS-ZP	6	7.5	60	5	17	9
	R-LX-06X075-CS-ZF	R-LX-06X075-CS-ZP	6	7.5	75	20	32	9
	-	R-LX-06X090-CS-ZP	6	7.5	90	35	47	9
	R-LX-06X100-CS-ZF	R-LX-06X100-CS-ZP	6	7.5	100	45	57	9
	R-LX-06X120-CS-ZF	R-LX-06X120-CS-ZP	6	7.5	120	65	75	9
	R-LX-06X130-CS-ZF	R-LX-06X130-CS-ZP	6	7.5	130	75	87	9
8	R-LX-08X060-CS-ZF	R-LX-08X060-CS-ZP	8	10	60	-	10	12
	R-LX-08X075-CS-ZF	R-LX-08X075-CS-ZP	8	10	75	5	30	12
	R-LX-08X090-CS-ZF	R-LX-08X090-CS-ZP	8	10	90	20	40	12
	R-LX-08X100-CS-ZF	R-LX-08X100-CS-ZP	8	10	100	30	50	12
	-	R-LX-08X120-CS-ZP	8	10	120	50	70	12
	R-LX-08X130-CS-ZF	R-LX-08X130-CS-ZP	8	10	130	60	80	12
8	R-LX-08X150-CS-ZF	R-LX-08X150-CS-ZP	8	10	150	80	100	12

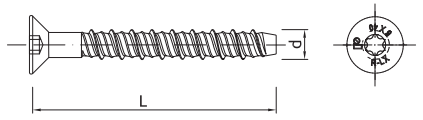

R-LX CONCRETE SCREW ANCHORS - STRUCTURAL FIXINGS

PRODUCT INFORMATION (cont.)

R-LX-CS COUNTERSUNK HEAD SCREW (cont.)

	Product Code		Drill	Anchor		Fixture		Hole diameter d _f [mm]
				Diameter	Length	Max. thickness t _{fix} for:		
				d [mm]	L [mm]	h _{nom,std} [mm]	h _{nom,red} [mm]	
	-	R-LX-10X060-CS-ZP	10	12.5	60	-	5	14
5	R-LX-10X065-CS-ZF	R-LX-10X065-CS-ZP	10	12.5	65	-	10	14
	R-LX-10X075-CS-ZF	R-LX-10X075-CS-ZP	10	12.5	75	-	20	14
	R-LX-10X085-CS-ZF	R-LX-10X085-CS-ZP	10	12.5	85	-	30	14
10	-	R-LX-10X090-CS-ZP	10	12.5	90	5	35	14
	R-LX-10X100-CS-ZF	R-LX-10X100-CS-ZP	10	12.5	100	15	45	14
	-	R-LX-10X110-CS-ZP	10	12.5	110	25	55	14
	R-LX-10X120-CS-ZF	R-LX-10X120-CS-ZP	10	12.5	120	35	65	14
	-	R-LX-10X130-CS-ZP	10	12.5	130	45	75	14
	R-LX-10X140-CS-ZF	R-LX-10X140-CS-ZP	10	12.5	140	55	85	14
	-	R-LX-10X150-CS-ZP	10	12.5	150	65	95	14
	R-LX-10X160-CS-ZF	R-LX-10X160-CS-ZP	10	12.5	160	75	105	14

R-LX-I, R-LX-I 8/10 INTERNALLY THREADED HEAD SCREW

	Product Code		Drill	Anchor		Fixture		Hole diameter d _f [mm]
				Diameter	Length	Max. thickness t _{fix} for:		
				d [mm]	L [mm]	h _{nom,std} [mm]	h _{nom,red} [mm]	
	-	R-LX-I-ZP						
6	-	R-LX-06X055-I08-ZP	6	7.5	55	-	-	-
	-	R-LX-06X055-I10-ZP	6	7.5	55	-	-	-
	-	R-LX-06X035-I8/10Z	6	7.5	35	-	-	-

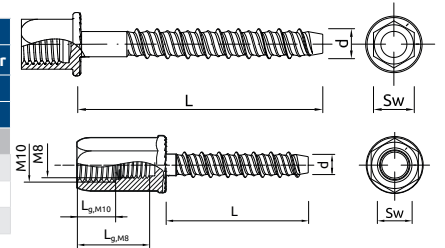

R-LX-E EXTERNALLY THREADED HEAD SCREW

	Product Code		Drill	Anchor		Fixture		Hole diameter d _f [mm]
				Diameter	Length	Max. thickness t _{fix} for:		
				d [mm]	L [mm]	h _{nom,std} [mm]	h _{nom,red} [mm]	
	-	R-LX-E-ZP						
6	-	R-LX-06X055-E8-ZP	6	7.5	55	-	-	-

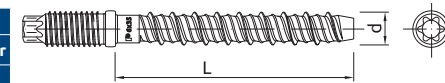

R-LX-PX-ZP PANHEAD XL SCREW

	Product Code		Drill	Anchor		Fixture		Hole diameter d _f [mm]
				Diameter	Length	Max. thickness t _{fix} for:		
				d [mm]	L [mm]	h _{nom,std} [mm]	h _{nom,red} [mm]	
	-	R-LX-PX-ZP						
6	-	R-LX-06X050-PX-ZP	6	7.5	50	-	7	9
	-	R-LX-06X055-PX-ZP	6	7.5	55	-	12	9

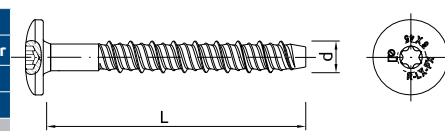

R-LX-H HEXAGONAL HEAD SCREW FOR TEMPORARY INSTALLATION

	Product Code		Drill	Anchor		Fixture		Hole diameter d _f [mm]
				Diameter	Length	Max. thickness t _{fix} for:		
				d [mm]	L [mm]	h _{nom,std} [mm]	h _{nom,red} [mm]	
	R-LX-H-ZF	R-LX-H-ZP						
8	*R-LX-08X060-H-ZF	*R-LX-08X060-H-ZP	8	10	60	-	10	12
	*R-LX-08X075-H-ZF	*R-LX-08X075-H-ZP	8	10	75	5	25	12
	*R-LX-08X090-H-ZF	*R-LX-08X090-H-ZP	8	10	90	20	40	12
	*R-LX-08X100-H-ZF	*R-LX-08X100-H-ZP	8	10	100	30	50	12
	*R-LX-08X130-H-ZF	*R-LX-08X130-H-ZP	8	10	130	60	80	12
	*R-LX-08X150-H-ZF	*R-LX-08X150-H-ZP	8	10	150	80	100	12
10	*R-LX-10X065-H-ZF	*R-LX-10X065-H-ZP	10	12.5	65	-	10	14
	*R-LX-10X075-H-ZF	*R-LX-10X075-H-ZP	10	12.5	75	-	20	14
	*R-LX-10X085-H-ZF	*R-LX-10X085-H-ZP	10	12.5	85	-	30	14
	*R-LX-10X100-H-ZF	*R-LX-10X100-H-ZP	10	12.5	100	15	45	14
	*R-LX-10X120-H-ZF	*R-LX-10X120-H-ZP	10	12.5	120	35	65	14
	*R-LX-10X140-H-ZF	*R-LX-10X140-H-ZP	10	12.5	140	55	85	14
14	-	*R-LX-10X160-H-ZP	10	12.5	160	75	105	14
	*R-LX-14X105-H-ZF	*R-LX-14X105-H-ZP	14	17	105	-	30	18
	*R-LX-14X135-H-ZF	*R-LX-14X135-H-ZP	14	17	135	15	60	18

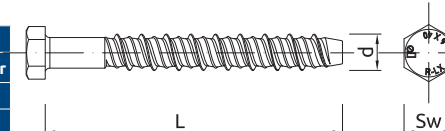

*not included in the approval

R-LX CONCRETE SCREW ANCHORS - STRUCTURAL FIXINGS

INSTALLATION DATA

R-LX-HF

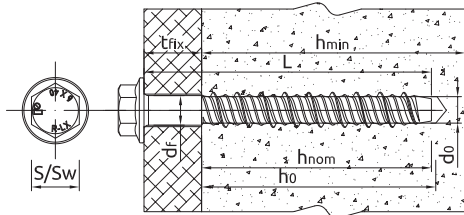

R-LX-CS

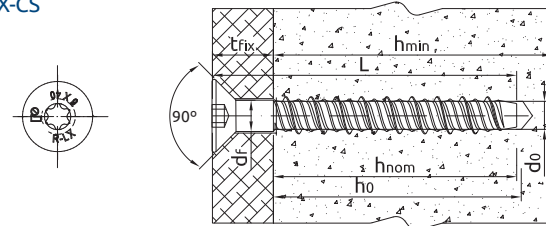

R-LX-I

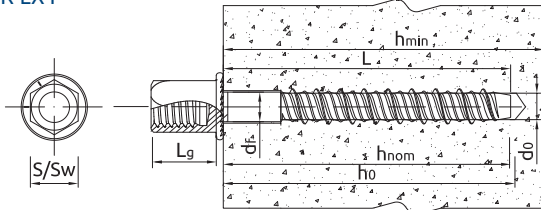

R-LX-I 8/10

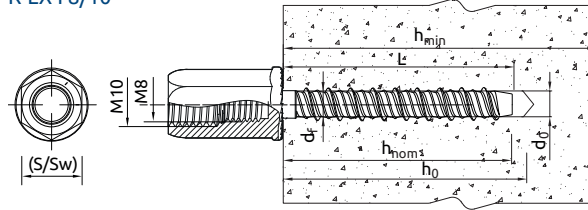

R-LX-E

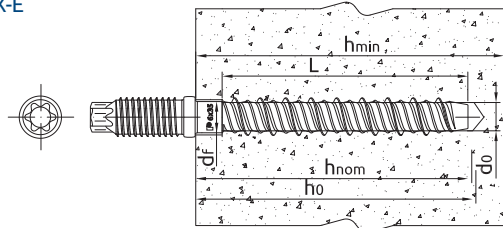

R-LX-H

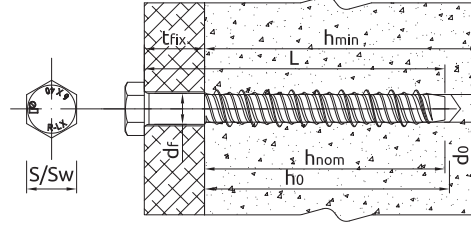

R-LX-PX-ZP

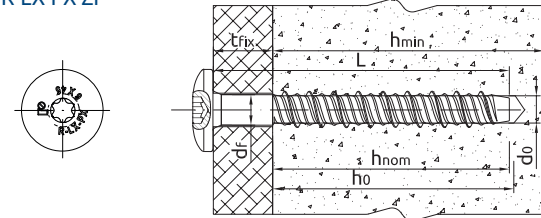

Size	5	6	8	10	12	14		
Thread diameter	d	[mm]	6.3	7.5	10	12.5	14.9	17
Hole diameter in substrate	d ₀	[mm]	5	6	8	10	12	14
Wrench size	Sw	[mm]	8	10	13	15	16	19
External diameter of washer		[mm]	12	14	18	22	27	32
Max. torque for impact screw driver	T _{imp,max}	[Nm]	200	400	900	950	950	950
STANDARD EMBEDMENT DEPTH								
Min. hole depth in substrate	h _{0,s}	[mm]	50	65	80	95	110	130
Real hole depth in substrate	h ₀	[mm]	L + 10 - t _{fix}	L + 10 - t _{fix}	L + 10 - t _{fix}	L + 10 - t _{fix}	L + 10 - t _{fix}	L + 10 - t _{fix}
Min. installation depth	h _{nom,s}	[mm]	43	55	70	85	100	120
Min. substrate thickness	h _{min,s}	[mm]	100	100	110	130	155	190
Min. spacing	s _{min,s}	[mm]	40	45	50	60	80	100
Min. edge distance	c _{min,s}	[mm]	40	45	50	60	80	100
REDUCED EMBEDMENT DEPTH								
Min. hole depth in substrate	h _{0,r}	[mm]	-	50	60	65	70	85
Real hole depth in substrate	h ₀	[mm]	-	L + 10 - t _{fix}	L + 10 - t _{fix}	L + 10 - t _{fix}	L + 10 - t _{fix}	L + 10 - t _{fix}
Min. installation depth	h _{nom,r}	[mm]	-	43	50	55	60	75
Min. substrate thickness	h _{min,r}	[mm]	-	100	100	100	110	110
Min. spacing	s _{min,r}	[mm]	-	45	50	60	80	100
Min. edge distance	c _{min,r}	[mm]	-	45	50	60	80	100

MECHANICAL PROPERTIES

Size	5	6	8	10	12	14		
Nominal ultimate tensile strength - tension	F _{uk}	[N/mm ²]	1300	1250	1200	1050	1000	1020
Nominal yield strength - tension	F _{yk}	[N/mm ²]	1150	1100	1050	950	900	800
Cross section area - tension	A _s	[mm ²]	19.6	28.3	50.3	78.5	113	153.9
Elastic section modulus	W _{el}	[mm ³]	12.2	21.2	50.3	98.1	169.4	269.3
Characteristic bending resistance	M ⁰ _{Rk,s}	[Nm]	19	31.8	72.4	123.6	203.3	329.6
Design bending resistance	M	[Nm]	12.7	21.2	48.3	82.4	135.5	219.7

R-LX CONCRETE SCREW ANCHORS - STRUCTURAL FIXINGS

BASIC PERFORMANCE DATA

Performance data for single anchor without influence of edge distance and spacing

Size	5	6	8	10	12	14	
NON-CRACKED CONCRETE C20/25							
Standard embedment depth h _{nom}	[mm]	43	35	70	85	100	120
Reduced embedment depth h _{nom}	[mm]	-	43	50	55	60	75
CRACKED CONCRETE C20/25							
Standard embedment depth h _{nom}	[mm]	43	35	70	85	100	120
Reduced embedment depth h _{nom}	[mm]	-	43	50	55	60	75
MEAN ULTIMATE LOAD							
TENSION LOAD N_{Ru,m}							
NON-CRACKED CONCRETE C20/25							
Standard embedment depth	[kN]	10.10	14.80	26.04	35.37	44.72	59.96
Reduced embedment depth	[kN]	-	12.22	14.58	17.08	18.37	26.79
CRACKED CONCRETE C20/25							
Standard embedment depth	[kN]	7.10	11.10	16.10	24.89	31.47	41.92
Reduced embedment depth	[kN]	-	8.60	10.10	10.70	10.80	17.40
SHEAR LOAD V_{Ru,m}							
NON-CRACKED CONCRETE C20/25							
Standard embedment depth	[kN]	14.66	18.37	26.04	51.91	71.19	98.91
Reduced embedment depth	[kN]	-	12.22	14.58	17.08	18.37	26.79
CRACKED CONCRETE C20/25							
Standard embedment depth	[kN]	10.32	12.93	18.33	49.78	62.94	83.83
Reduced embedment depth	[kN]	-	8.60	10.26	12.02	12.93	18.85
CHARACTERISTIC LOAD							
TENSION LOAD N_{Rk}							
NON-CRACKED CONCRETE C20/25							
Standard embedment depth	[kN]	7.00	12.00	18.98	25.78	32.59	43.41
Reduced embedment depth	[kN]	-	8.90	10.63	12.45	13.39	19.52
CRACKED CONCRETE C20/25							
Standard embedment depth	[kN]	4.50	7.00	13.00	18.05	22.82	30.39
Reduced embedment depth	[kN]	-	6.23	7.00	8.00	7.00	13.00
SHEAR LOAD V_{Rk}							
NON-CRACKED CONCRETE C20/25							
Standard embedment depth	[kN]	8.90	13.39	18.98	41.20	57.00	78.50
Reduced embedment depth	[kN]	-	8.90	10.63	12.45	13.39	19.52
CRACKED CONCRETE C20/25							
Standard embedment depth	[kN]	6.23	9.37	13.29	36.09	45.63	60.77
Reduced embedment depth	[kN]	-	6.23	7.44	8.71	9.37	13.66
DESIGN LOAD							
TENSION LOAD N_{Rd}							
NON-CRACKED CONCRETE C20/25							
Standard embedment depth	[kN]	3.89	8.00	12.65	17.19	21.73	28.94
Reduced embedment depth	[kN]	-	5.94	7.08	8.30	8.93	13.01
CRACKED CONCRETE C20/25							
Standard embedment depth	[kN]	2.50	4.67	8.67	12.03	15.21	20.26
Reduced embedment depth	[kN]	-	4.16	4.67	5.33	4.67	8.67
SHEAR LOAD V_{Rd}							
NON-CRACKED CONCRETE C20/25							
Standard embedment depth	[kN]	5.94	8.93	12.65	27.47	38.00	52.33
Reduced embedment depth	[kN]	-	5.94	7.08	8.30	8.93	13.01
CRACKED CONCRETE C20/25							
Standard embedment depth	[kN]	4.16	6.25	8.86	24.06	30.42	40.52
Reduced embedment depth	[kN]	-	4.16	4.96	5.81	6.25	9.11

R-LX CONCRETE SCREW ANCHORS - STRUCTURAL FIXINGS

DESIGN PERFORMANCE DATA

(-) failure is not decisive

Size			5	6	8	10	12	14					
Min. installation depth	h_{nom}	[mm]	43	43	55	50	70	55	85	60	100	75	120
Effective embedment depth	h_{ef}	[mm]	32	32	42	36	53	40	65	42	76	54	92
TENSION LOAD													
STEEL FAILURE													
Characteristic resistance	$N_{Rk,s}$	[kN]	25.50	35.40	35.40	60.40	60.40	82.40	82.40	113.00	113.00	157.00	157.00
Partial safety factor	γ_{Ms}	-	1.40	1.40	1.40	1.40	1.40	1.40	1.40	1.40	1.40	1.50	1.50
PULL-OUT FAILURE; NON-CRACKED CONCRETE C20/25													
Characteristic resistance	$N_{Rk,p}$	[kN]	7.00	-	12.00	-	-	-	-	-	-	-	-
PULL-OUT FAILURE; CRACKED CONCRETE C20/25													
Characteristic resistance	$N_{Rk,p}$	[kN]	4.50	-	7.00	7.00	13.00	8.00	-	7.00	-	13.00	-
PULL-OUT FAILURE													
Installation safety factor	V_{inst}	-	1.20	1.00	1.00	1.00	1.00	1.00	1.00	1.00	1.00	1.00	1.00
Increasing factors for $N_{Rk,p}$ - C30/37	ψ_c	-	1.08	1.08	1.08	1.08	1.08	1.08	1.08	1.08	1.08	1.08	1.08
Increasing factors for $N_{Rk,p}$ - C40/50	ψ_c	-	1.15	1.15	1.15	1.15	1.15	1.15	1.15	1.15	1.15	1.15	1.15
Increasing factors for $N_{Rk,p}$ - C50/60	ψ_c	-	1.19	1.19	1.19	1.19	1.19	1.19	1.19	1.19	1.19	1.19	1.19
CONCRETE CONE FAILURE													
Installation safety factor	V_{inst}	-	1.20	1.00	1.00	1.00	1.00	1.00	1.00	1.00	1.00	1.00	1.00
Factor for cracked concrete	$k_{cr,N}$	-	7.70	7.70	7.70	7.70	7.70	7.70	7.70	7.70	7.70	7.70	7.70
Factor for non-cracked concrete	$k_{ucr,N}$	-	11	11	11	11	11	11	11	11	11	11	11
Spacing	$s_{cr,N}$	[mm]	90	90	126	112	160	120	196	126	228	165	276
Edge distance	$c_{cr,N}$	[mm]	45	45	63	56	80	60	98	63	114	83	138
CONCRETE SPLITTING FAILURE													
Installation safety factor	V_{inst}	-	1.20	1.00	1.00	1.00	1.00	1.00	1.00	1.00	1.00	1.00	1.00
Spacing	$s_{cr,sp}$	[mm]	90	90	126	112	160	136	222	126	228	188	312
Edge distance	$c_{cr,sp}$	[mm]	45	45	63	56	80	68	111	63	114	94	156
SHEAR LOAD													
STEEL FAILURE													
Characteristic resistance without lever arm	$V_{Rk,s}$	[kN]	12.70	17.70	17.70	30.20	30.20	41.20	41.20	57.00	57.00	78.50	78.50
Ductility factor	k_{γ}	-	0.80	0.80	0.80	0.80	0.80	0.80	0.80	0.80	0.80	0.80	0.80
Characteristic resistance with lever arm	$M_{Rk,s}$	[Nm]	19.00	31.80	31.80	72.40	72.40	123.60	123.60	203.30	203.30	329.60	329.60
Partial safety factor	γ_{Ms}	-	1.50	1.50	1.50	1.50	1.50	1.50	1.50	1.50	1.50	1.50	1.50
CONCRETE PRY-OUT FAILURE													
Factor	k	-	1.00	1.00	1.00	1.00	1.00	2.00	1.00	2.00	1.00	2.00	1.00
Installation safety factor	V_{inst}	-	1.00	1.00	1.00	1.00	1.00	1.00	1.00	1.00	1.00	1.00	1.00
CONCRETE EDGE FAILURE													
Effective length of anchor	ℓ_f	[mm]	43	43	35	50	70	55	85	60	100	75	120
Anchor diameter	d_{nom}	[mm]	5	6	6	8	8	10	10	12	12	14	14
Installation safety factor	V_{inst}	-	1.00	1.00	1.00	1.00	1.00	1.00	1.00	1.00	1.00	1.00	1.00

Characteristic Resistance under fire exposure in concrete C20/25 to C50/60

Size			5	6	8	10	12	14					
Effective embedment depth	h_{ef}	[mm]	32.00	32.00	42.00	36.00	53.00	40.00	65.00	42.00	76.00	54.00	92.00
R (for EI) = 30 min													
TENSION LOAD													
STEEL FAILURE													
Characteristic resistance	$N_{Rk,s}$	[kN]	0.20	0.28	0.28	0.75	0.75	1.57	1.57	2.26	2.26	3.08	3.08
PULL-OUT FAILURE													
Characteristic resistance	$N_{Rk,p}$	[kN]	1.13	1.38	1.75	1.88	3.25	2.00	4.75	1.75	6.50	3.25	8.50
SHEAR LOAD													
STEEL FAILURE													
Characteristic resistance without lever arm	$V_{Rk,s}$	[kN]	0.20	0.28	0.28	0.75	0.75	1.57	1.57	2.26	2.26	3.08	3.08
Characteristic resistance with lever arm	$M_{Rk,s}$	[Nm]	0.15	0.25	0.25	0.90	0.90	2.36	2.36	4.07	4.07	6.47	6.47
R (for EI) = 60 min													
TENSION LOAD													
STEEL FAILURE													
Characteristic resistance	$N_{Rk,s}$	[kN]	0.18	0.25	0.25	0.65	0.65	1.18	1.18	1.70	1.70	2.31	2.31
PULL-OUT FAILURE													
Characteristic resistance	$N_{Rk,p}$	[kN]	1.13	1.38	1.75	1.88	3.25	2.00	4.75	1.75	6.50	3.25	8.50
SHEAR LOAD													
STEEL FAILURE													
Characteristic resistance without lever arm	$V_{Rk,s}$	[kN]	0.18	0.25	0.25	0.65	0.65	1.18	1.18	1.70	1.70	2.31	2.31
Characteristic resistance with lever arm	$M_{Rk,s}$	[Nm]	0.13	0.23	0.23	0.78	0.78	1.77	1.77	3.05	3.05	4.85	4.85

R-LX CONCRETE SCREW ANCHORS - STRUCTURAL FIXINGS

DESIGN PERFORMANCE DATA

Characteristic Resistance under fire exposure in concrete C20/25 to C50/60

Size			5	6	8	10	12	14					
R (for EI) = 90 min													
TENSION LOAD													
STEEL FAILURE													
Characteristic resistance	$N_{Rk,s}$	[kN]	0.14	0.20	0.20	0.50	0.50	1.02	1.02	1.47	1.47	2.00	2.00
PULL-OUT FAILURE													
Characteristic resistance	$N_{Rk,p}$	[kN]	1.13	1.38	1.75	1.88	3.25	2.00	4.75	1.75	6.50	3.25	8.50
SHEAR LOAD													
STEEL FAILURE													
Characteristic resistance without lever arm	$V_{Rk,s}$	[kN]	0.14	0.20	0.20	0.50	0.50	1.02	1.02	1.47	1.47	2.00	2.00
Characteristic resistance with lever arm	$M_{Rk,s}$	[Nm]	0.10	0.18	0.18	0.60	0.60	1.53	1.53	2.65	2.65	4.20	4.20
R (for EI) = 120 min													
TENSION LOAD													
STEEL FAILURE													
Characteristic resistance	$N_{Rk,s}$	[kN]	0.10	0.14	0.14	0.40	0.40	0.79	0.79	1.13	1.13	1.54	1.54
PULL-OUT FAILURE													
Characteristic resistance	$N_{Rk,p}$	[kN]	0.90	1.10	1.40	1.50	2.60	1.60	3.80	1.40	5.20	2.60	6.80
SHEAR LOAD													
STEEL FAILURE													
Characteristic resistance without lever arm	$V_{Rk,s}$	[kN]	0.10	0.14	0.14	0.40	0.40	0.79	0.79	1.13	1.13	1.54	1.54
Characteristic resistance with lever arm	$M_{Rk,s}$	[Nm]	0.07	0.13	0.13	0.48	0.48	1.18	1.18	2.04	2.04	3.23	3.23

Allowable values for resistance in case of Seismic performance category C1

Size			8	10	14
Effective embedment depth	h_{ef}	[mm]	53	65	92
TENSION LOAD, STEEL FAILURE					
Characteristic resistance	$N_{Rk,s}$	[kN]	60.40	82.40	157.00
Partial safety factor	$\gamma_{Ms,seisC1}$	-	1.40	1.40	1.50
TENSION LOAD, PULL-OUT FAILURE					
Characteristic resistance	$N_{Rk,p}$	[kN]	5.40	13.50	19.20
Installation safety factor	V_{inst}	-	1.00	1.00	1.00
SHEAR LOAD, STEEL FAILURE					
Characteristic resistance without lever arm	$V_{Rk,s}$	[kN]	15.10	27.40	52.30
Partial safety factor	$\gamma_{Ms,seisC1}$	-	1.50	1.50	1.50

Allowable values for resistance in case of Seismic performance category C2

Size			8	10	14
Effective embedment depth	h_{ef}	[mm]	53	65	92
TENSION LOAD, STEEL FAILURE					
Characteristic resistance	$N_{Rk,s}$	[kN]	60.40	82.40	157.00
Partial safety factor	$\gamma_{Ms,seisC2}$	-	1.40	1.40	1.50
TENSION LOAD, PULL-OUT FAILURE					
Characteristic resistance	$N_{Rk,p}$	[kN]	1.57	4.91	14.87
Installation safety factor	V_{inst}	-	1.00	1.00	1.00
SHEAR LOAD, STEEL FAILURE					
Characteristic resistance without lever arm	$V_{Rk,s}$	[kN]	9.90	20.60	35.10
Partial safety factor	$\gamma_{Ms,seisC2}$	-	1.50	1.50	1.50

R-HPTIIA4 STAINLESS STEEL THROUGH BOLT

Stainless steel throughbolt anchor for cracked and non-cracked concrete



FEATURES AND BENEFITS

- Stainless steel anchor for the highest corrosion resistance
- High performance in cracked and non-cracked concrete confirmed by ETA Option 1
- Highest quality ensures maximum load capability
- For applications requiring fire resistance up to 120 minutes
- Suitable for reduced embedment to avoid contact with reinforcement
- Embedment depth markings help to ensure precise installation of the anchor
- Design of R-HPTII allows drilling and installing directly through the fixture and helps to reduce installation time
- Suitable for installation in corrosive environments category C1, C2, C3, C4 and C5

APPLICATIONS

- Cladding restraints
- Barriers
- Structural steel
- Curtain walling
- Handrails
- Heavy Plant
- Balustrading
- Passenger lifts
- Facades
- Fencing & gates manufacturing and installation
- Masonry support
- Platforms
- Public seating
- Racking systems

BASE MATERIALS

- Approved for use in:
- Cracked concrete C20/25-C50/60
 - Non-cracked concrete C20/25-C50/60
 - Reinforced concrete
 - Unreinforced concrete
- Also suitable for use in:
- Natural Stone (after site testing)

INSTALLATION GUIDE



- Drill a hole of required diameter and depth.
- Clear the hole of drilling dust and debris (using blow pump and brush or equivalent method).
- Lightly tap the throughbolt through the fixture into hole with a hammer, until fixing depth is reached.
- Tighten to the recommended torque.
- After installation.

PRODUCT INFORMATION

Size	Product Code		Anchor		Fixture		
	Regular washer DIN 125A	Large washer DIN 9021	Diameter	Length	Max. thickness t_{fix} for:		Hole diameter
			d [mm]	L [mm]	$h_{nom,red}$ [mm]	$h_{nom,std}$ [mm]	d_f [mm]
M8	R-HPTIIA4-08060/10	R-HPTIIA4D08060/10	8	60	10	-	9
	R-HPTIIA4-08075/10	R-HPTIIA4D08075/10	8	75	25	10	9
	R-HPTIIA4-08085/20	R-HPTIIA4D08085/20	8	85	35	20	9
	R-HPTIIA4-08095/30	R-HPTIIA4D08095/30	8	95	45	30	9
	R-HPTIIA4-08105/40	R-HPTIIA4D08105/40	8	105	55	40	9
	R-HPTIIA4-08115/50	R-HPTIIA4D08115/50	8	115	65	50	9
M10	R-HPTIIA4-10065/5	R-HPTIIA4D10065/5	10	65	5	-	11
	R-HPTIIA4-10080/20	R-HPTIIA4D10080/20	10	80	20	-	11
	R-HPTIIA4-10095/15	R-HPTIIA4D10095/15	10	95	35	15	11
	R-HPTIIA4-10115/35	R-HPTIIA4D10115/35	10	115	55	35	11
	R-HPTIIA4-10130/50	R-HPTIIA4D10130/50	10	130	70	50	11
	R-HPTIIA4-10140/60	R-HPTIIA4D10140/60	10	140	80	60	11

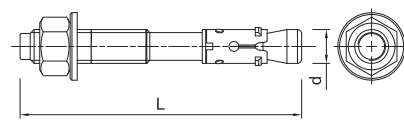

R-HPTIIA4 STAINLESS STEEL THROUGH BOLT

PRODUCT INFORMATION

Size	Product Code		Anchor		Fixture		
	Regular washer DIN 125A	Large washer DIN 9021	Diameter	Length	Max. thickness t_{fix} for:		Hole diameter
			d [mm]	L [mm]	$h_{nom,red}$ [mm]	$h_{nom,std}$ [mm]	d_f [mm]
M12	R-HPTIIA4-12080/5	R-HPTIIA4D12080/5	12	80	5	-	13
	R-HPTIIA4-12100/5	R-HPTIIA4D12100/5	12	100	25	5	13
	R-HPTIIA4-12115/20	R-HPTIIA4D12115/20	12	115	40	20	13
	R-HPTIIA4-12125/30	R-HPTIIA4D12125/30	12	125	50	30	13
	R-HPTIIA4-12150/55	R-HPTIIA4D12150/55	12	150	75	55	13
	R-HPTIIA4-12180/85	R-HPTIIA4D12180/85	12	180	105	85	13
M16	R-HPTIIA4-16125/5	R-HPTIIA4D16125/5	16	125	25	5	18
	R-HPTIIA4-16140/20	R-HPTIIA4D16140/20	16	140	40	20	18
	R-HPTIIA4-16150/30	R-HPTIIA4D16150/30	16	150	50	30	18
	R-HPTIIA4-16180/60	R-HPTIIA4D16180/60	16	180	80	60	18

INSTALLATION DATA

Size		M8	M10	M12	M16	
Thread diameter	d	[mm]	8	10	12	16
Hole diameter in substrate	d_o	[mm]	8	10	12	16
Installation torque	T_{inst}	[Nm]	15	30	50	100
Wrench size	Sw	[mm]	13	17	19	24
External diameter of washer		[mm]	16	20	24	30
STANDARD EMBEDMENT DEPTH						
Min. hole depth in substrate	$h_{0,s}$	[mm]	65	80	90	110
Min. installation depth	$h_{nom,s}$	[mm]	55	69	80	100
Min. substrate thickness	$h_{min,s}$	[mm]	100	120	140	170
Min. spacing (Non-cracked concrete)	$s_{min,s}$	[mm]	55	70	90	135
Min. spacing (Cracked concrete)	$s_{min,s}$	[mm]	55	70	90	135
Min. edge distance (Non-cracked concrete)	$c_{min,s}$	[mm]	40	50	55	80
Min. edge distance (Cracked concrete)	$c_{min,s}$	[mm]	40	45	55	70
REDUCED EMBEDMENT DEPTH						
Min. hole depth in substrate	$h_{0,r}$	[mm]	50	60	70	90
Min. installation depth	$h_{nom,r}$	[mm]	40	49	60	80
Min. substrate thickness	$h_{min,r}$	[mm]	100	100	100	130
Min. spacing (Non-cracked concrete)	$s_{min,r}$	[mm]	50	70	120	150
Min. spacing (Cracked concrete)	$s_{min,r}$	[mm]	50	70	120	150
Min. edge distance (Non-cracked concrete)	$c_{min,r}$	[mm]	50	60	70	90
Min. edge distance (Cracked concrete)	$c_{min,r}$	[mm]	40	50	70	85

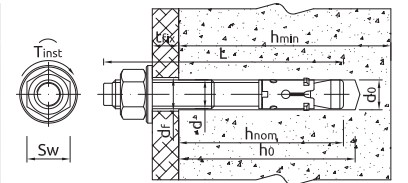

MECHANICAL PROPERTIES

Size		M8	M10	M12	M16	
Nominal ultimate tensile strength - tension	F_{tk}	[N/mm ²]	600	600	550	550
Nominal yield strength - tension	F_{yk}	[N/mm ²]	450	450	413	413
Cross sectional area - tension	A_s	[mm ²]	36.6	58	84.3	157
Elastic section modulus	W_{el}	[mm ³]	50.27	98.17	169.65	402.12
Characteristic bending resistance	$M^0_{Rk,s}$	[Nm]	22	45	72	180
Design bending resistance	M	[Nm]	18	36	57	144

BASIC PERFORMANCE DATA

Performance data for single anchor without influence of edge distance and spacing

Size		M8	M10	M12	M16
NON-CRACKED CONCRETE					
Standard embedment depth h_{ef}	[mm]	47	59	68	85
Reduced embedment depth h_{ef}	[mm]	32	39	48	65
CRACKED CONCRETE					
Standard embedment depth h_{ef}	[mm]	47	59	68	85
Reduced embedment depth h_{ef}	[mm]	32	39	48	65

R-HPTIIA4 STAINLESS STEEL THROUGH BOLT

BASIC PERFORMANCE DATA

Size		M8	M10	M12	M16
MEAN ULTIMATE LOAD					
TENSION LOAD $N_{Ru,m}$					
NON-CRACKED CONCRETE					
Standard embedment depth	[kN]	15.40	22.80	29.20	55.80
Reduced embedment depth	[kN]	10.40	16.00	22.10	37.90
CRACKED CONCRETE					
Standard embedment depth	[kN]	9.70	11.50	18.60	30.40
Reduced embedment depth	[kN]	5.60	9.80	13.40	22.20
SHEAR LOAD $V_{Ru,m}$					
NON-CRACKED CONCRETE					
Standard embedment depth	[kN]	14.00	22.20	29.60	54.50
Reduced embedment depth	[kN]	12.22	19.73	22.45	54.50
CRACKED CONCRETE					
Standard embedment depth	[kN]	12.87	21.20	29.60	54.50
Reduced embedment depth	[kN]	8.60	13.88	15.80	49.78
CHARACTERISTIC LOAD					
TENSION LOAD N_{Rk}					
NON-CRACKED CONCRETE					
Standard embedment depth	[kN]	9.00	16.00	25.00	38.55
Reduced embedment depth	[kN]	7.50	11.98	16.36	25.78
CRACKED CONCRETE					
Standard embedment depth	[kN]	6.00	9.00	12.00	25.00
Reduced embedment depth	[kN]	3.00	7.50	9.00	16.00
SHEAR LOAD V_{Rk}					
NON-CRACKED CONCRETE					
Standard embedment depth	[kN]	11.70	18.50	24.60	45.40
Reduced embedment depth	[kN]	8.90	14.38	16.36	45.40
CRACKED CONCRETE					
Standard embedment depth	[kN]	11.10	15.61	24.60	45.40
Reduced embedment depth	[kN]	6.23	10.06	11.45	36.09
DESIGN LOAD					
TENSION LOAD N_{Rd}					
NON-CRACKED CONCRETE					
Standard embedment depth	[kN]	5.00	10.67	16.70	25.70
Reduced embedment depth	[kN]	4.17	6.66	10.91	17.19
CRACKED CONCRETE					
Standard embedment depth	[kN]	3.33	6.00	8.00	16.67
Reduced embedment depth	[kN]	1.67	4.17	6.00	10.67
SHEAR LOAD V_{Rd}					
NON-CRACKED CONCRETE					
Standard embedment depth	[kN]	9.36	14.80	19.68	36.32
Reduced embedment depth	[kN]	5.94	9.59	10.91	34.37
CRACKED CONCRETE					
Standard embedment depth	[kN]	7.40	10.40	19.68	35.98
Reduced embedment depth	[kN]	4.16	6.71	7.63	24.06

DESIGN PERFORMANCE DATA

(-) failure is not decisive

Size		M8	M10	M12	M16				
Effective embedment depth	h_{ef} [mm]	32	47	39	59	48	68	65	85
TENSION LOAD									
STEEL FAILURE									
Characteristic resistance	$N_{Rk,s}$ [kN]	21.20	21.20	33.60	33.60	44.80	44.80	82.60	82.60
Partial safety factor	γ_{Ms}	1.50	1.50	1.50	1.50	1.50	1.50	1.50	1.50
PULL-OUT FAILURE; NON-CRACKED CONCRETE C20/25									
Characteristic resistance	$N_{Rk,p}$ [kN]	7.50	9.00	12.00	16.00	-	25.00	-	-

R-HPTIIA4 STAINLESS STEEL THROUGH BOLT

DESIGN PERFORMANCE DATA (cont.)

Size		M8	M10	M12	M16				
PULL-OUT FAILURE; CRACKED CONCRETE C20/25									
Characteristic resistance	$N_{Rk,p}$ [kN]	3.00	6.00	7.50	9.00	9.00	12.00	16.00	25.00
PULL-OUT FAILURE									
Installation safety factor	γ_{inst}	-	1.20	1.20	1.20	1.00	1.00	1.00	1.00
Increasing factors for $N_{Rd,p}$ - C30/37	ψ_c	-	1.07	1.16	1.07	1.26	1.16	1.23	1.18
Increasing factors for $N_{Rd,p}$ - C40/50	ψ_c	-	1.13	1.33	1.13	1.52	1.32	1.45	1.37
Increasing factors for $N_{Rd,p}$ - C50/60	ψ_c	-	1.20	1.50	1.20	1.78	1.49	1.67	1.55
CONCRETE CONE FAILURE									
Factor for cracked concrete	$k_{cr,N}$	-	7.70	7.70	7.70	7.70	7.70	7.70	7.70
Factor for non-cracked concrete	$k_{ucr,N}$	-	11.00	11.00	11.00	11.00	11.00	11.00	11.00
Installation safety factor	γ_{inst}	-	1.20	1.20	1.20	1.00	1.00	1.00	1.00
Spacing	$s_{cr,N}$ [mm]	96	141	117	177	144	204	195	255
Edge distance	$c_{cr,N}$ [mm]	48	71	59	89	72	102	98	128
CONCRETE SPLITTING FAILURE									
Spacing	$s_{cr,sp}$ [mm]	160	240	200	300	250	340	320	430
Edge distance	$c_{cr,sp}$ [mm]	80	120	100	150	125	170	160	215
Installation safety factor	γ_{inst}	-	1.20	1.20	1.20	1.00	1.00	1.00	1.00
SHEAR LOAD									
STEEL FAILURE									
Characteristic resistance without lever arm	$V_{Rk,s}$ [kN]	11.70	11.70	18.50	18.50	24.60	24.60	45.40	45.40
Ductility factor	k_γ	-	0.80	0.80	0.80	0.80	0.80	0.80	0.80
Characteristic resistance with lever arm	$M_{Rk,s}$ [Nm]	22.00	22.00	42.00	45.00	72.00	72.00	180.00	180.00
Partial safety factor	γ_{Ms}	-	1.25	1.25	1.25	1.25	1.25	1.25	1.25
CONCRETE PRY-OUT FAILURE									
Factor	k	-	1.00	1.00	1.20	1.00	1.00	2.00	2.00
Installation safety factor	γ_{inst}	-	1.00	1.00	1.00	1.00	1.00	1.00	1.00
CONCRETE EDGE FAILURE									
Effective length of anchor	l_f [mm]	32	47	39	59	48	68	65	85
Anchor diameter	d_{nom} [mm]	8	8	10	10	12	12	16	16
Installation safety factor	γ_{inst}	-	1.00	1.00	1.00	1.00	1.00	1.00	1.00

The use of the reduced embedment depth M8 and M10 is restricted to anchoring statically indeterminate structural components.

DESIGN PERFORMANCE DATA

Resistance to tension and shear loads under fire exposure - Reduced embedment depth

Size		M8	M10	M12	M16				
Effective embedment depth	h_{ef} [mm]	32	47	39	59	48	68	65	85
R (for EI) = 30 min									
TENSION LOAD									
STEEL FAILURE									
Characteristic resistance	$N_{Rk,s}$ [kN]	0.70	0.70	1.50	1.50	2.50	2.50	4.70	4.70
PULL-OUT FAILURE									
Characteristic resistance	$N_{Rk,p}$ [kN]	0.80	1.50	1.90	2.30	2.30	3.00	4.00	6.30
SHEAR LOAD									
STEEL FAILURE									
Characteristic resistance without lever arm	$V_{Rk,s}$ [kN]	0.70	0.70	1.50	1.50	2.50	2.50	4.70	4.70
Characteristic resistance with lever arm	$M_{Rk,s}$ [Nm]	0.70	0.70	1.90	1.90	3.90	3.90	10.00	10.00
R (for EI) = 60 min									
TENSION LOAD									
STEEL FAILURE									
Characteristic resistance	$N_{Rk,s}$ [kN]	0.60	0.60	1.20	1.20	2.10	2.10	3.90	3.90
PULL-OUT FAILURE									
Characteristic resistance	$N_{Rk,p}$ [kN]	0.80	1.50	1.90	2.30	2.30	3.00	4.00	6.30
SHEAR LOAD									
STEEL FAILURE									
Characteristic resistance without lever arm	$V_{Rk,s}$ [kN]	0.60	0.60	1.20	1.20	2.10	2.10	3.90	3.90
Characteristic resistance with lever arm	$M_{Rk,s}$ [Nm]	0.60	0.60	1.50	1.50	3.30	3.30	8.30	8.30

R-HPTIIA4 STAINLESS STEEL THROUGH BOLT

DESIGN PERFORMANCE DATA (cont.)

Size			M8	M10	M12	M16				
R (for EI) = 90 min										
TENSION LOAD										
STEEL FAILURE										
Characteristic resistance	$N_{Rk,s}$	[kN]	0.40	0.40	0.90	0.90	1.70	1.70	3.10	3.10
PULL-OUT FAILURE										
Characteristic resistance	$N_{Rk,p}$	[kN]	0.80	1.50	1.90	2.30	2.30	3.00	4.00	6.30
STEEL FAILURE										
Characteristic resistance without lever arm	$V_{Rk,s}$	[kN]	0.40	0.40	0.90	0.90	1.70	1.70	3.10	3.10
Characteristic resistance with lever arm	$M_{Rk,s}$	[Nm]	0.40	0.40	1.20	1.20	2.60	2.60	6.70	6.70
R (for EI) = 120 min										
TENSION LOAD										
STEEL FAILURE										
Characteristic resistance	$N_{Rk,s}$	[kN]	0.40	0.40	0.80	0.80	1.30	1.30	2.50	2.50
PULL-OUT FAILURE										
Characteristic resistance	$N_{Rk,p}$	[kN]	0.60	1.20	1.50	1.80	1.80	2.40	3.20	5.00
STEEL FAILURE										
Characteristic resistance without lever arm	$V_{Rk,s}$	[kN]	0.40	0.40	0.80	0.80	1.30	1.30	2.50	2.50
Characteristic resistance with lever arm	$M_{Rk,s}$	[Nm]	0.40	0.40	1.00	1.00	2.10	2.10	5.30	5.30

DESIGN PERFORMANCE DATA

Allowable values for resistance in case of Seismic performance category C1

Size			M8	M10	M12	M16				
Effective embedment depth	h_{ef}	[mm]	32	47	39	59	48	68	65	85
TENSION LOAD, STEEL FAILURE										
Characteristic resistance	$N_{Rk,s}$	[kN]	21.20	21.20	33.60	33.60	44.80	44.80	82.60	82.60
Partial safety factor	$\gamma_{M2,seisC1}$	-	1.50	1.50	1.50	1.50	1.50	1.50	1.50	1.50
TENSION LOAD, PULL-OUT FAILURE										
Characteristic resistance	$N_{Rk,p}$	[kN]	3.00	6.00	7.50	9.00	9.00	12.00	16.00	25.00
Installation safety factor	γ_{inst}	-	1.20	1.20	1.20	1.00	1.00	1.00	1.00	1.00
SHEAR LOAD, STEEL FAILURE										
Characteristic resistance without lever arm	$V_{Rk,s}$	[kN]	-	6.70	-	12.50	18.40	18.40	39.00	39.00
Partial safety factor	$\gamma_{M2,seisC1}$	-	1.25	1.25	1.25	1.25	1.25	1.25	1.25	1.25

Allowable values for resistance in case of Seismic performance category C2

Size			M10	M12		
Effective embedment depth	h_{ef}	[mm]	39	59	48	68
TENSION LOAD, STEEL FAILURE						
Characteristic resistance	$N_{Rk,s}$	[kN]	33.60	33.60	44.80	44.80
Partial safety factor	$\gamma_{M2,seisC1}$	-	1.50	1.50	1.50	1.50
TENSION LOAD, PULL-OUT FAILURE						
Characteristic resistance	$N_{Rk,p}$	[kN]	2.60	3.00	3.00	4.20
Installation safety factor	γ_{inst}	-	1.20	1.00	1.00	1.00
SHEAR LOAD, STEEL FAILURE						
Characteristic resistance without lever arm	$V_{Rk,s}$	[kN]	-	8.30	-	11.10
Partial safety factor	$\gamma_{M2,seisC1}$	-	-	1.25	-	1.25

R-HPTII-ZF ZINC FLAKE THROUGH BOLT

Zinc Flake Throughbolt anchor for cracked and non-cracked concrete



FEATURES AND BENEFITS

- New generation of throughbolt with unique corrosion-resistant coating
- High performance in cracked and non-cracked concrete confirmed by ETA Option 1
- Highest quality ensures maximum load capability
- For applications requiring fire resistance up to 120 minutes
- Suitable for reduced embedment to avoid contact with reinforcement
- Embedment depth markings help to ensure precise installation of the anchor
- Design of R-HPTII allows drilling and installing directly through the fixture and helps to reduce installation time
- Fire resistant

APPLICATIONS

- Cladding restraints
- Consoles
- Barriers
- Structural steel
- Curtain walling
- Handrails
- Heavy Plant
- Balustrading
- Passenger lifts
- Facades
- Racking systems
- Platforms
- Fencing & gates manufacturing and installation

BASE MATERIALS

- Approved for use in:
 - Cracked concrete C20/25-C50/60
 - Non-cracked concrete C20/25-C50/60
 - Reinforced concrete
 - Unreinforced concrete
- Also suitable for use in:
 - Natural Stone (after site testing)

INSTALLATION GUIDE



1. Drill a hole of required diameter and depth
2. Clear the hole of drilling dust and debris (using blowpump or equivalent method)
3. Lightly tap the throughbolt through the fixture into hole with a hammer, until fixing depth is reached
4. Tighten to the recommended torque

PRODUCT INFORMATION

Size	Product Code		Anchor		Fixture		
	Regular washer DIN 125A	Large washer DIN 9021	Diameter	Length	Max. thickness $t_{f, for}$:		Hole diameter
			[mm]	[mm]	$h_{nom,red}$ [mm]	$h_{nom,std}$ [mm]	d_f [mm]
M8	R-HPTIIZF-08065/15	R-HPTIIZFD08065/15	8	65	15	-	9
	R-HPTIIZF-08080/15	R-HPTIIZFD08080/15	8	80	30	15	9
	R-HPTIIZF-08100/35	R-HPTIIZFD08100/35	8	100	50	35	9
	R-HPTIIZF-08115/50	R-HPTIIZFD08115/50	8	115	65	50	9
M10	R-HPTIIZF-10065/5	R-HPTIIZFD10065/5	10	65	5	-	11
	R-HPTIIZF-10080/20	R-HPTIIZFD10080/20	10	80	20	-	11
	R-HPTIIZF-10095/15	R-HPTIIZFD10095/15	10	95	35	15	11
	R-HPTIIZF-10115/35	R-HPTIIZFD10115/35	10	115	55	35	11
M12	R-HPTIIZF-10130/50	R-HPTIIZFD10130/50	10	130	70	50	11
	R-HPTIIZF-12080/5	R-HPTIIZFD12080/5	12	80	5	-	13
	R-HPTIIZF-12100/5	R-HPTIIZFD12100/5	12	100	25	5	13
	R-HPTIIZF-12120/25	R-HPTIIZFD12120/25	12	120	45	25	13
M16	R-HPTIIZF-12135/40	R-HPTIIZFD12135/40	12	135	60	40	13
	R-HPTIIZF-12150/55	R-HPTIIZFD12150/55	12	150	75	55	13
	R-HPTIIZF-16105/10	R-HPTIIZFD16105/10	16	105	10	-	18
	R-HPTIIZF-16125/5	-	16	125	25	5	18
M20	R-HPTIIZF-16140/20	R-HPTIIZFD16140/20	16	140	40	20	18
	R-HPTIIZF-16180/60	R-HPTIIZFD16180/60	16	180	80	60	18
	R-HPTIIZF-16220/100	-	16	220	120	100	18
	R-HPTIIZF-20125/5	R-HPTIIZFD20125/5	20	125	5	-	22
M20	R-HPTIIZF-20160/20	R-HPTIIZFD20160/20	20	160	40	20	22
	R-HPTIIZF-20200/60	-	20	200	80	60	22

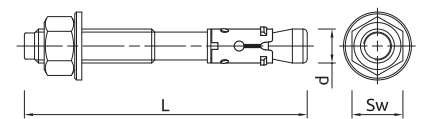

R-HPTII-ZF ZINC FLAKE THROUGH BOLT

INSTALLATION DATA

Size			M8	M10	M12	M16	M20
Thread diameter	d	[mm]	8	10	12	16	20
Hole diameter in substrate	d ₀	[mm]	8	10	12	16	20
Installation torque	T _{inst}	[Nm]	10	20	40	100	180
Wrench size	Sw	[mm]	13	17	19	24	30
External diameter of washer		[mm]	16	20	24	30	37
STANDARD EMBEDMENT DEPTH							
Min. hole depth in substrate	h _{0,s}	[mm]	65	79	90	110	129
Min. installation depth	h _{nom,s}	[mm]	55	69	80	100	119
Min. substrate thickness	h _{min,s}	[mm]	100	120	140	170	200
Min. spacing (Non-cracked concrete)	s _{min,s}	[mm]	50	70	90	160	180
Min. spacing (Cracked concrete)	s _{min,s}	[mm]	50	70	90	160	180
Min. edge distance (Non-cracked concrete)	c _{min,s}	[mm]	40	50	65	85	100
Min. edge distance (Cracked concrete)	c _{min,s}	[mm]	40	45	65	90	100
REDUCED EMBEDMENT DEPTH							
Min. hole depth in substrate	h _{0,r}	[mm]	50	59	70	90	110
Min. installation depth	h _{nom,r}	[mm]	40	49	60	80	100
Min. substrate thickness	h _{min,r}	[mm]	100	100	100	130	160
Min. spacing (Non-cracked concrete)	s _{min,r}	[mm]	55	75	150	190	300
Min. spacing (Cracked concrete)	s _{min,r}	[mm]	55	75	150	190	300
Min. edge distance (Non-cracked concrete)	c _{min,r}	[mm]	45	60	70	100	160
Min. edge distance (Cracked concrete)	c _{min,r}	[mm]	40	50	80	110	120

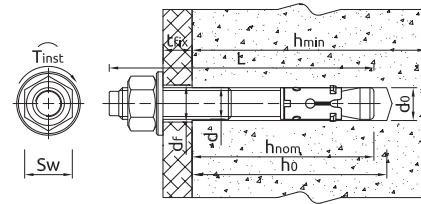

MECHANICAL PROPERTIES

Size			M8	M10	M12	M16	M20
Nominal ultimate tensile strength - tension	F _{uk}	[N/mm ²]	620	620	620	620	620
Nominal ultimate tensile strength - shear	F _{uk}	[N/mm ²]	520	520	520	520	520
Nominal yield strength - tension	F _{yk}	[N/mm ²]	531	531	531	531	531
Nominal yield strength - shear	F _{yk}	[N/mm ²]	416	416	416	416	416
Cross sectional area - tension	A _s	[mm ²]	25.5	40.7	60.1	106.6	162.9
Cross sectional area - shear	A _s	[mm ²]	38.9	61.7	89.6	165.2	259.1
Elastic section modulus	W _{el}	[mm ³]	34.3	68.3	119.6	299.5	588.3
Characteristic bending resistance	M ⁰ _{Rk,s}	[Nm]	19	38	67	167	328
Design bending resistance	M	[Nm]	15	31	53	134	263

BASIC PERFORMANCE DATA

Performance data for single anchor without influence of edge distance and spacing

Size		M8	M10	M12	M16	M20
NON-CRACKED CONCRETE						
Standard embedment depth h _{ef}	[mm]	47	59	68	85	99
Reduced embedment depth h _{ef,r}	[mm]	32	39	48	65	80
CRACKED CONCRETE						
Standard embedment depth h _{ef}	[mm]	47	59	68	85	99
Reduced embedment depth h _{ef,r}	[mm]	32	39	48	65	80
MEAN ULTIMATE LOAD						
TENSION LOAD N_{Rk,m}						
NON-CRACKED CONCRETE						
Standard embedment depth	[kN]	12.40	20.60	27.70	45.50	64.80
Reduced embedment depth	[kN]	9.60	13.60	17.60	34.50	47.10
CRACKED CONCRETE						
Standard embedment depth	[kN]	7.50	12.50	19.90	27.30	41.90
Reduced embedment depth	[kN]	4.80	8.60	12.80	26.80	32.70
SHEAR LOAD V_{Rk,m}						
NON-CRACKED CONCRETE						
Standard embedment depth	[kN]	12.20	19.20	28.00	51.50	80.90
Reduced embedment depth	[kN]	10.10	16.44	22.45	51.50	80.90
CRACKED CONCRETE						
Standard embedment depth	[kN]	12.20	19.20	28.00	51.50	80.90
Reduced embedment depth	[kN]	8.60	11.57	15.80	49.78	66.66
CHARACTERISTIC LOAD						
TENSION LOAD N_{Rk}						
NON-CRACKED CONCRETE						
Standard embedment depth	[kN]	9.00	12.00	20.00	35.00	48.46
Reduced embedment depth	[kN]	7.50	9.00	12.00	25.78	35.20

R-HPTII-ZF ZINC FLAKE THROUGH BOLT

BASIC PERFORMANCE DATA

Size		M8	M10	M12	M16	M20
CRACKED CONCRETE						
Standard embedment depth	[kN]	5.00	9.00	12.00	20.00	30.00
Reduced embedment depth	[kN]	3.00	6.00	9.00	16.00	24.64
SHEAR LOAD V_{Rk}						
NON-CRACKED CONCRETE						
Standard embedment depth	[kN]	9.10	15.70	23.70	47.10	60.60
Reduced embedment depth	[kN]	8.90	11.98	16.36	47.10	60.60
CRACKED CONCRETE						
Standard embedment depth	[kN]	9.10	15.61	23.70	47.10	60.60
Reduced embedment depth	[kN]	6.23	8.39	11.45	36.09	49.28
DESIGN LOAD						
TENSION LOAD N_{rd}						
NON-CRACKED CONCRETE						
Standard embedment depth	[kN]	5.00	8.00	13.33	23.33	32.30
Reduced embedment depth	[kN]	4.17	5.00	8.00	17.19	23.47
CRACKED CONCRETE						
Standard embedment depth	[kN]	2.78	6.00	8.00	13.33	20.00
Reduced embedment depth	[kN]	1.67	3.33	6.00	10.67	16.43
SHEAR LOAD V_{rd}						
NON-CRACKED CONCRETE						
Standard embedment depth	[kN]	7.28	12.56	18.96	37.68	48.48
Reduced embedment depth	[kN]	5.94	7.99	10.91	34.37	46.93
CRACKED CONCRETE						
Standard embedment depth	[kN]	7.28	10.40	18.96	35.98	45.23
Reduced embedment depth	[kN]	4.16	5.59	7.63	24.06	32.85

DESIGN PERFORMANCE DATA

(-) failure is not decisive

Size		M8	M10	M12	M16	M20						
Effective embedment depth	h _{ef}	[mm]	32	47	39	59	48	68	65	85	80	99
TENSION LOAD												
STEEL FAILURE												
Characteristic resistance	N _{Rk,s}	[kN]	11.00	11.00	17.50	17.50	25.80	25.80	45.80	45.80	70.00	70.00
Partial safety factor	γ _{Ms}	-	1.40	1.40	1.40	1.40	1.40	1.40	1.40	1.40	1.40	1.40
PULL-OUT FAILURE; NON-CRACKED CONCRETE C20/25												
Characteristic resistance	N _{Rk,p}	[kN]	7.50	9.00	9.00	12.00	12.00	20.00	-	35.00	-	-
PULL-OUT FAILURE; CRACKED CONCRETE C20/25												
Characteristic resistance	N _{Rk,p}	[kN]	3.00	5.00	6.00	9.00	9.00	12.00	16.00	20.00	-	30.00
PULL-OUT FAILURE												
Installation safety factor	γ _{inst}	-	1.20	1.20	1.20	1.00	1.00	1.00	1.00	1.00	1.00	1.00
Increasing factors for N _{Rk,p} - C30/37	ψ _c	-	1.20	1.12	1.16	1.22	1.22	1.00	1.11	1.14	1.12	1.07
Increasing factors for N _{Rk,p} - C40/50	ψ _c	-	1.40	1.22	1.33	1.44	1.44	1.00	1.22	1.28	1.26	1.14
Increasing factors for N _{Rk,p} - C50/60	ψ _c	-	1.60	1.33	1.50	1.67	1.67	1.00	1.33	1.43	1.39	1.21
CONCRETE CONE FAILURE												
Factor for cracked concrete	k _{cr,N}	-	7.70	7.70	7.70	7.70	7.70	7.70	7.70	7.70	7.70	7.70
Factor for non-cracked concrete	k _{ucr,N}	-	11.00	11.00	11.00	11.00	11.00	11.00	11.00	11.00	11.00	11.00
Installation safety factor	γ _{inst}	-	1.20	1.20	1.20	1.00	1.00	1.00	1.00	1.00	1.00	1.00
Spacing	s _{cr,N}	[mm]	96	141	117	177	144	204	195	255	240	297
Edge distance	c _{cr,N}	[mm]	48	71	59	89	72	102	98	128	120	149
CONCRETE SPLITTING FAILURE												
Spacing	s _{cr,sp}	[mm]	170	220	200	300	250	340	320	430	410	530
Edge distance	c _{cr,sp}	[mm]	85	110	100	150	125	170	160	215	205	265
Installation safety factor	γ _{inst}	-	1.20	1.20	1.20	1.00	1.00	1.00	1.00	1.00	1.00	1.00
SHEAR LOAD												
STEEL FAILURE												
Characteristic resistance without lever arm	V _{Rk,s}	[kN]	9.10	9.10	15.70	15.70	23.70	23.70	47.10	47.10	60.60	60.60
Ductility factor	k _γ	-	0.80	0.80	0.80	0.80	0.80	0.80	0.80	0.80	0.80	0.80
Characteristic resistance with lever arm	M _{Rk,s}	[Nm]	22	22	45	45	79	79	200	200	389	389
Partial safety factor	γ _{Ms}	-	1.25	1.25	1.25	1.25	1.25	1.25	1.25	1.25	1.25	1.25
CONCRETE PRY-OUT FAILURE												
Factor	k	-	1.00	1.00	1.00	1.00	1.00	2.00	2.00	2.00	2.00	2.00
Installation safety factor	γ _{inst}	-	1.00	1.00	1.00	1.00	1.00	1.00	1.00	1.00	1.00	1.00
CONCRETE EDGE FAILURE												
Effective length of anchor	ℓ _f	[mm]	32	47	39	59	48	68	65	85	80	99
Anchor diameter	d _{nom}	[mm]	8	8	10	10	12	12	16	16	20	20
Installation safety factor	γ _{inst}	-	1.00	1.00	1.00	1.00	1.00	1.00	1.00	1.00	1.00	1.00

The use of the reduced embedment depth M8 and M10 is restricted to anchoring statically indeterminate structural components.

R-HPTII-ZF ZINC FLAKE THROUGHBOLT

DESIGN PERFORMANCE DATA

Performance data for single anchor without influence of edge distance and spacing

Size			M8		M10		M12		M16		M20	
Effective embedment depth	h_{ef}	[mm]	32	47	39	59	48	68	65	85	80	99
R (for EI) = 30 min												
TENSION LOAD												
STEEL FAILURE												
Characteristic resistance	$N_{Rk,s}$	[kN]	0.40	0.40	0.90	0.90	1.70	1.70	3.10	3.10	4.90	4.90
PULL-OUT FAILURE												
Characteristic resistance	$N_{Rk,p}$	[kN]	0.80	1.30	1.50	2.30	2.30	3.00	4.00	5.00	-	-
SHEAR LOAD												
STEEL FAILURE												
Characteristic resistance without lever arm	$V_{Rk,s}$	[kN]	0.40	0.40	0.90	0.90	1.70	1.70	3.10	3.10	4.90	4.90
Characteristic resistance with lever arm	$M_{Rk,s}$	[Nm]	0.40	0.40	1.10	1.10	2.60	2.60	6.70	6.70	13.00	13.00
R (for EI) = 60 min												
TENSION LOAD												
STEEL FAILURE												
Characteristic resistance	$N_{Rk,s}$	[kN]	0.30	0.30	0.80	0.80	1.30	1.30	2.40	2.40	3.70	3.70
PULL-OUT FAILURE												
Characteristic resistance	$N_{Rk,p}$	[kN]	0.80	1.30	1.50	2.30	2.30	3.00	4.00	5.00	-	-
SHEAR LOAD												
STEEL FAILURE												
Characteristic resistance without lever arm	$V_{Rk,s}$	[kN]	0.30	0.30	0.80	0.80	1.30	1.30	2.40	2.40	3.70	3.70
Characteristic resistance with lever arm	$M_{Rk,s}$	[Nm]	0.30	0.30	1.00	1.00	2.00	2.00	5.00	5.00	9.70	9.70
R (for EI) = 90 min												
TENSION LOAD												
STEEL FAILURE												
Characteristic resistance	$N_{Rk,s}$	[kN]	0.30	0.30	0.60	0.60	1.10	1.10	2.00	2.00	3.20	3.20
PULL-OUT FAILURE												
Characteristic resistance	$N_{Rk,p}$	[kN]	0.80	1.30	1.50	2.30	2.30	3.00	4.00	5.00	-	-
SHEAR LOAD												
STEEL FAILURE												
Characteristic resistance without lever arm	$V_{Rk,s}$	[kN]	0.30	0.30	0.60	0.60	1.10	1.10	2.00	2.00	3.20	3.20
Characteristic resistance with lever arm	$M_{Rk,s}$	[Nm]	0.30	0.30	0.70	0.70	1.70	1.70	4.30	4.30	8.40	8.40
R (for EI) = 120 min												
TENSION LOAD												
STEEL FAILURE												
Characteristic resistance	$N_{Rk,s}$	[kN]	0.20	0.20	0.50	0.50	0.80	0.80	1.60	1.60	2.50	2.50
PULL-OUT FAILURE												
Characteristic resistance	$N_{Rk,p}$	[kN]	0.60	1.00	1.20	1.80	1.80	2.40	3.20	4.00	-	-
SHEAR LOAD												
STEEL FAILURE												
Characteristic resistance without lever arm	$V_{Rk,s}$	[kN]	0.20	0.20	0.50	0.50	0.80	0.80	1.60	1.60	2.50	2.50
Characteristic resistance with lever arm	$M_{Rk,s}$	[Nm]	0.20	0.20	0.60	0.60	1.30	1.30	3.30	3.30	6.50	6.50

DESIGN PERFORMANCE DATA

Allowable values for resistance in case of Seismic performance category C1

Size			M8		M10		M12		M16		M20	
Effective embedment depth	h_{ef}	[mm]	32	47	39	59	48	68	65	85	80	99
TENSION LOAD, STEEL FAILURE												
Characteristic resistance	$N_{Rk,s}$	[kN]	11.00	11.00	17.50	17.50	25.80	25.80	45.80	45.80	70.00	70.00
Partial safety factor	$V_{Msd,seisC1}$	-	1.40	1.40	1.40	1.40	1.40	1.40	1.40	1.40	1.40	1.40
TENSION LOAD, PULL-OUT FAILURE												
Characteristic resistance	$N_{Rk,p}$	[kN]	3.00	5.00	6.00	9.00	9.00	12.00	16.00	20.00	-	30.00
Installation safety factor	V_{inst}	-	1.20	1.20	1.20	1.00	1.00	1.00	1.00	1.00	1.00	1.00
SHEAR LOAD, STEEL FAILURE												
Characteristic resistance without lever arm	$V_{Rk,s}$	[kN]	-	5.20	-	9.40	23.80	23.80	33.30	33.30	55.10	55.10
Partial safety factor	$V_{Msd,seisC1}$	-	1.25	1.25	1.25	1.25	1.25	1.25	1.25	1.25	1.25	1.25

Allowable values for resistance in case of Seismic performance category C2

Size			M10		M12		M16	
Effective embedment depth	h_{ef}	[mm]	59		68		85	
TENSION LOAD, STEEL FAILURE								
Characteristic resistance	$N_{Rk,s}$	[kN]	17.50		25.80		45.80	
Partial safety factor	$V_{Msd,seisC2}$	-	1.40		1.40		1.40	
TENSION LOAD, PULL-OUT FAILURE								
Characteristic resistance	$N_{Rk,p}$	[kN]	3.40		7.00		10.90	
Installation safety factor	V_{inst}	-	1.00		1.00		1.00	
SHEAR LOAD, STEEL FAILURE								
Characteristic resistance without lever arm	$V_{Rk,s}$	[kN]	9.20		11.10		28.20	
Partial safety factor	$V_{Msd,seisC2}$	-	1.25		1.25		1.25	

R-XPTII-A4 STAINLESS STEEL THROUGHBOLT

Stainless steel throughbolt for non-cracked concrete



FEATURES AND BENEFITS

- Stainless steel anchor for the highest corrosion resistance
- High performance in non-cracked concrete confirmed by ETA Option 7
- Highest quality ensures maximum load capability
- Suitable for reduced embedment to avoid contact with reinforcement
- Embedment depth markings help to ensure precise installation of the anchor
- Simple through-installation (drilling and installation through fixed material)

APPLICATIONS

- Cladding restraint
- Curtain wall
- Balustrading
- Barriers
- Handrails
- Racking
- Structural steel
- Bollards

BASE MATERIALS

- Approved for use in:
- Non-cracked concrete C20/25-C50/60
 - Unreinforced concrete
 - Reinforced concrete
- Also suitable for use in:
- Natural Stone (after site testing)

INSTALLATION GUIDE



- Drill a hole of required diameter and depth
- Clear the hole of drilling dust and debris (using blowpump or equivalent method)
- Lightly tap the throughbolt through the fixture into hole with a hammer, until fixing depth is reached
- Insert bolt through fixture and tighten to the recommended torque

PRODUCT INFORMATION

Size	Product Code	Anchor		Fixture		
		Diameter d [mm]	Length L [mm]	Max. thickness t_{fix} for:		Hole diameter d_f [mm]
				$h_{nom,red}$ [mm]	$h_{nom,std}$ [mm]	
M6*	R-XPTIIA4-06050/10	6	50	10	-	7
	R-XPTIIA4-06055/10	6	55	15	-	7
	R-XPTIIA4-06085/25	6	85	45	25	7
	R-XPTIIA4-06100/40	6	100	40	-	7
M8	R-XPTIIA4-08060/10	8	60	10	-	9
	R-XPTIIA4-08065/15	8	65	15	-	9
	R-XPTIIA4-08075/10	8	75	25	10	9
	R-XPTIIA4-08085/20	8	85	35	20	9
	R-XPTIIA4-08095/30	8	95	45	30	9
	R-XPTIIA4-08105/40	8	105	55	40	9
M10	R-XPTIIA4-08115/50	8	115	65	50	9
	R-XPTIIA4-10065/5	10	65	5	-	11
	R-XPTIIA4-10080/20	10	80	20	-	11
	R-XPTIIA4-10095/15	10	95	35	15	11
	R-XPTIIA4-10115/35	10	115	55	35	11
	R-XPTIIA4-10130/50	10	130	70	50	11
M12	R-XPTIIA4-10140/60	10	140	80	60	11
	R-XPTIIA4-12080/5	12	80	5	-	13
	R-XPTIIA4-12100/5	12	100	25	5	13
	R-XPTIIA4-12115/20	12	115	40	20	13
	R-XPTIIA4-12125/30	12	125	50	30	13
	R-XPTIIA4-12150/55	12	150	75	55	13
	R-XPTIIA4-12180/85	12	180	105	85	13
	R-XPTIIA4-12120/25	12	120	45	25	13

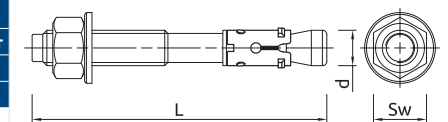

* Not covered by ETA

R-XPTII-A4 STAINLESS STEEL THROUGH BOLT

PRODUCT INFORMATION (cont.)

Size	Product Code	Anchor		Fixture		
		Diameter	Length	Max. thickness t_{fix} For:		Hole diameter
		d [mm]	L [mm]	$h_{nom,red}$ [mm]	$h_{nom,std}$ [mm]	d_f [mm]
M16	R-XPTIIA4-16125/5	16	125	25	5	18
	R-XPTIIA4-16140/20	16	140	40	20	18
	R-XPTIIA4-16150/30	16	150	50	30	18
	R-XPTIIA4-16180/60	16	180	80	60	18
	R-XPTIIA4-16220/100	16	220	120	100	18
M20*	R-XPTIIA4-20125/5	20	125	5	-	22
	R-XPTIIA4-20160/20	20	160	40	20	22
	R-XPTIIA4-20200/60	20	200	80	60	22
	R-XPTIIA4-20300/16	20	300	180	160	22
M24*	R-XPTIIA4-24260/10	24	260	115	100	26

* Not covered by ETA

INSTALLATION DATA

Size	M6	M8	M10	M12	M16	M20	M24		
Thread diameter	d	[mm]	6	8	10	12	16	20	24
Hole diameter in substrate	d_o	[mm]	6	8	10	12	16	20	24
Installation torque	T_{inst}	[Nm]	5	15	30	50	100	180	320
Wrench size	Sw	[mm]	10	13	17	19	24	30	36
External diameter of washer		[mm]	12	16	20	24	30	37	44
STANDARD EMBEDMENT DEPTH									
Min. hole depth in substrate	$h_{o,s}$	[mm]	55	65	79	90	110	140	155
Min. installation depth	$h_{nom,s}$	[mm]	50	55	69	80	100	120	135
Min. substrate thickness	$h_{min,s}$	[mm]	100	100	120	140	170	210	230
Min. spacing (Non-cracked concrete)	$s_{min,s}$	[mm]	45	65	90	110	170	170	180
Min. edge distance (Non-cracked concrete)	$c_{min,s}$	[mm]	50	50	60	85	90	160	200
REDUCED EMBEDMENT DEPTH									
Min. hole depth in substrate	$h_{o,r}$	[mm]	40	50	59	70	90	120	140
Min. installation depth	$h_{nom,r}$	[mm]	30	40	49	60	80	100	120
Min. substrate thickness	$h_{min,r}$	[mm]	100	100	100	100	130	210	230
Min. spacing (Non-cracked concrete)	$s_{min,r}$	[mm]	40	65	115	150	190	160	190
Min. edge distance (Non-cracked concrete)	$c_{min,r}$	[mm]	45	50	80	100	120	125	160

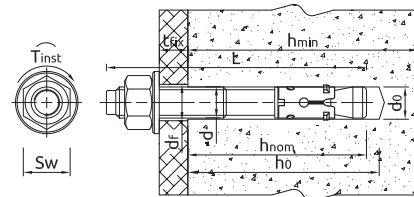

MECHANICAL PROPERTIES

Size	M6	M8	M10	M12	M16	M20	M24	
Nominal ultimate tensile strength - tension	F_{uk}	[N/mm ²]	800	600	600	550	500	500
Nominal yield strength - tension	F_{yk}	[N/mm ²]	600	480	480	440	400	210
Cross sectional area - tension	A_s	[mm ²]	14.25	25.5	40.7	60.1	106.6	234.52
Elastic section modulus	W_{el}	[mm ³]	13.15	31.2	62.3	109	276.4	539.9
Characteristic bending resistance	$M^b_{Rk,s}$	[Nm]	12.62	22	45	72	180	323.9
Design bending resistance	M	[Nm]	9.49	17.6	36	57.6	144	136.11

BASIC PERFORMANCE DATA

Performance data for single anchor without influence of edge distance and spacing - ETAG 001

Size	M6	M8	M10	M12	M16	M20	M24								
Effective embedment depth	h_{ef}	22	42	32	47	39	59	48	68	65	85	85	105	97	112
MEAN ULTIMATE LOAD															
TENSION LOAD $N_{Rd,m}$															
Standard embedment depth	[kN]	9.80	15.40	22.80	30.39	52.90	24.00	30.00							
Reduced embedment depth	[kN]	1.90	10.40	16.00	22.10	37.90	14.40	19.20							
SHEAR LOAD $V_{Rd,m}$															
Standard embedment depth	[kN]	9.80	12.87	20.35	27.06	49.94	48.00	60.00							
Reduced embedment depth	[kN]	1.90	12.22	16.44	22.45	49.94	28.80	38.40							
CHARACTERISTIC LOAD															
TENSION LOAD N_{Rk}															
Standard embedment depth	[kN]	7.50	9.00	16.00	25.00	38.55	20.00	25.00							
Reduced embedment depth	[kN]	1.50	7.50	11.98	16.36	25.78	12.00	16.00							
SHEAR LOAD V_{Rk}															
Standard embedment depth	[kN]	7.50	11.70	18.50	24.60	45.40	40.00	50.00							
Reduced embedment depth	[kN]	1.50	8.90	11.98	16.36	45.40	24.00	32.00							

R-XPTII-A4

BASIC PERFORMANCE DATA (cont.)

Size	M6	M8	M10	M12	M16	M20	M24	
DESIGN LOAD								
TENSION LOAD N_{Rd}								
Standard embedment depth	[kN]	2.97	5.00	10.67	16.67	25.70	7.94	9.92
Reduced embedment depth	[kN]	0.59	4.17	6.66	10.91	17.19	4.76	6.35
SHEAR LOAD V_{Rd}								
Standard embedment depth	[kN]	6.00	9.36	14.80	19.68	36.32	32.00	40.00
Reduced embedment depth	[kN]	1.20	5.94	7.99	10.91	34.37	19.20	25.60

DESIGN PERFORMANCE DATA

(-) failure is not decisive

Size	M6	M8	M10	M12	M16	M20	M24									
Effective embedment depth	h_{ef}	[mm]	22	42	32	47	39	59	48	68	65	85	85	105	97	112
TENSION LOAD																
STEEL FAILURE																
Characteristic resistance	$N_{Rk,s}$	[kN]	11.83	11.83	21.20	21.20	33.60	36.60	44.80	44.80	82.60	82.60	114.03	114.03	164.10	164.16
Partial safety factor	γ_{Ms}	-	1.60	1.60	1.50	1.50	1.50	1.50	1.50	1.50	1.50	1.50	1.50	2.86	2.86	2.86
PULL-OUT FAILURE; NON-CRACKED CONCRETE C20/25																
Characteristic resistance	$N_{Rk,p}$	[kN]	1.50	7.50	7.50	9.00	12.00	16.00	-	25.00	-	-	12.00	20.00	16.00	25.00
PULL-OUT FAILURE																
Installation safety factor	γ_{inst}	-	1.68	1.68	1.20	1.20	1.20	1.00	1.00	1.00	1.00	1.00	1.68	1.68	1.68	1.68
Increasing factors for $N_{Rd,p}$ - C30/37	ψ_c	-	1.22	1.22	1.17	1.22	1.22	1.22	1.22	1.22	1.22	1.22	1.22	1.22	1.22	1.22
Increasing factors for $N_{Rd,p}$ - C40/50	ψ_c	-	1.41	1.41	1.32	1.41	1.41	1.41	1.41	1.41	1.41	1.41	1.41	1.41	1.41	1.41
Increasing factors for $N_{Rd,p}$ - C50/60	ψ_c	-	1.55	1.55	1.42	1.55	1.55	1.55	1.55	1.55	1.55	1.55	1.55	1.55	1.55	1.55
CONCRETE CONE FAILURE																
Factor for non-cracked concrete	$k_{ucr,N}$	-	11.00	11.00	11.00	11.00	11.00	11.00	11.00	11.00	11.00	11.00	11.00	11.00	11.00	11.00
Installation safety factor	γ_{inst}	-	1.68	1.68	1.20	1.20	1.20	1.00	1.00	1.00	1.00	1.00	1.68	1.68	1.68	1.68
Spacing	$s_{cr,N}$	[mm]	66	126	96	141	117	177	144	204	195	255	255	315	291	336
Edge distance	$c_{cr,N}$	[mm]	33	63	48	71	59	89	72	102	98	128	128	168	146	168
CONCRETE SPLITTING FAILURE																
Spacing	$s_{cr,sp}$	[mm]	100	210	160	240	200	300	250	340	320	430	430	560	500	580
Edge distance	$c_{cr,sp}$	[mm]	55	105	80	120	100	150	125	170	160	215	215	280	250	290
Installation safety factor	γ_{inst}	-	1.68	1.68	1.20	1.20	1.20	1.00	1.00	1.00	1.00	1.00	1.68	1.68	1.68	1.68
SHEAR LOAD																
STEEL FAILURE																
Characteristic resistance without lever arm	$V_{Rk,s}$	[kN]	8.04	8.04	11.70	11.70	18.50	18.50	24.60	24.60	45.40	45.40	61.25	61.25	88.25	88.25
Ductility factor	k_{γ}	-	0.80	0.80	0.80	0.80	0.80	0.80	0.80	0.80	0.80	0.80	0.80	0.80	0.80	0.80
Characteristic resistance with lever arm	$M_{Rk,s}$	[Nm]	12.62	12.62	22.00	22.00	45.00	45.00	72.00	72.00	180.00	180.00	323.94	323.94	564.54	564.54
Partial safety factor	γ_{Ms}	-	1.33	1.33	1.25	1.25	1.25	1.25	1.25	1.25	1.25	1.25	1.25	2.38	2.38	2.38
CONCRETE PRY-OUT FAILURE																
Factor	k	-	1.00	1.00	1.00	1.00	1.00	1.00	1.00	2.00	2.00	2.00	2.00	2.00	2.00	2.00
Installation safety factor	γ_{inst}	-	1.00	1.00	1.00	1.00	1.00	1.00	1.00	1.00	1.00	1.00	1.00	1.00	1.00	1.00
CONCRETE EDGE FAILURE																
Effective length of anchor	ℓ_f	[mm]	22	42	32	47	39	59	48	68	65	85	85	105	97	112
Anchor diameter	d_{nom}	[mm]	6	6	8	8	10	10	12	12	16	16	20	20	24	24
Installation safety factor	γ_{inst}	-	1.00	1.00	1.00	1.00	1.00	1.00	1.00	1.00	1.00	1.00	1.00	1.00	1.00	1.00

The use of the reduced embedment depth M8 and M10 is restricted to anchoring statically indeterminate structural components.

R-XPTIII-HD HOT DIP GALVANIZED THROUGHBOLT

Hot Dip Galvanized throughbolt for non-cracked concrete



FEATURES AND BENEFITS

- Increased corrosion resistance due to hot dip zinc external protection layer
- R-XPT is suitable for reduced embedment to avoid contact with reinforcement
- Embedment depth markings help to ensure precise installation of the anchor
- Design of R-XPTII allows drilling and installing directly through the fixture and helps to reduce installation time
- High quality with cost effectiveness
- Cold formed body ensures consistent dimensional accuracy

APPLICATIONS

- Cladding restraint
- Curtain wall
- Balustrading
- Barriers
- Handrails
- Racking
- Structural steel
- Bollards

BASE MATERIALS

- Approved for use in:
 - Non-cracked concrete C20/25-C50/60
 - Unreinforced concrete
 - Reinforced concrete
- Also suitable for use in:
 - Natural Stone (after site testing)

INSTALLATION GUIDE



1. Drill a hole of required diameter and depth
2. Clear the hole of drilling dust and debris (using blowpump or equivalent method)
3. Lightly tap the throughbolt through the fixture into hole with a hammer, until fixing depth is reached
4. Tighten to the recommended torque

PRODUCT INFORMATION

Size	Product Code	Anchor		Fixture		
		Diameter	Length	Max. thickness t_{fix} for:		Hole diameter
		d	L	$h_{nom,red}$	$h_{nom,std}$	d_f
		[mm]	[mm]	[mm]	[mm]	[mm]
M8	R-XPTIII-HD-08065/15	8	65	15	-	9
	R-XPTIII-HD-08075/10	8	75	25	10	9
	R-XPTIII-HD-08080/15	8	80	30	15	9
	R-XPTIII-HD-08095/30	8	95	45	30	9
	R-XPTIII-HD-08115/50	8	115	65	50	9
	R-XPTIII-HD-08140/75	8	140	90	75	9
M10	R-XPTIII-HD-10080/10	10	80	20	10	11
	R-XPTIII-HD-10095/25	10	95	35	25	11
	R-XPTIII-HD-10115/45	10	115	55	45	11
	R-XPTIII-HD-10130/60	10	130	70	60	11
M12	R-XPTIII-HD-10140/70	10	140	80	70	11
	R-XPTIII-HD-12100/5	12	100	25	5	13
	R-XPTIII-HD-12120/25	12	120	45	25	13
	R-XPTIII-HD-12125/30	12	125	50	30	13
	R-XPTIII-HD-12135/40	12	135	60	40	13
	R-XPTIII-HD-12150/55	12	150	75	55	13
	R-XPTIII-HD-12180/85	12	180	105	85	13
	R-XPTIII-HD-12220/125	12	220	145	125	13
M16	R-XPTIII-HD-16125/5	16	125	25	5	18
	R-XPTIII-HD-16140/20	16	140	40	20	18
	R-XPTIII-HD-16150/30	16	150	50	30	18
	R-XPTIII-HD-16180/60	16	180	80	60	18
R-XPTIII-HD-16220/100	16	220	120	100	18	

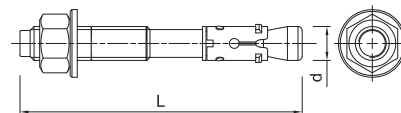

R-XPTIII-HD HOT DIP GALVANIZED THROUGHBOLT

INSTALLATION DATA

Size		M8	M10	M12	M16
Thread diameter	d	8	10	12	16
Hole diameter in substrate	d_o	8	10	12	16
Installation torque	T_{inst}	15	30	50	100
Wrench size	Sw	13	17	19	24
STANDARD EMBEDMENT DEPTH					
Min. hole depth in substrate	$h_{0,s}$	65	70	90	110
Min. installation depth	$h_{nom,s}$	55	60	80	100
Min. substrate thickness	$h_{min,s}$	100	100	140	170
Min. spacing	$s_{min,s}$	50	70	75	95
Min. edge distance	$c_{min,s}$	40	60	65	85

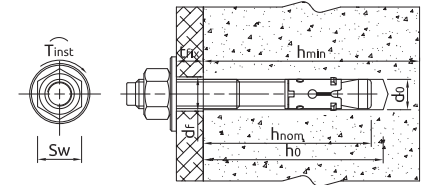

MECHANICAL PROPERTIES

Size		M8	M10	M12	M16	
Nominal ultimate tensile strength - tension	f_{uk}	[N/mm ²]	650	650	650	650
Nominal yield strength - tension	f_{yk}	[N/mm ²]	520	520	520	520
Cross sectional area - tension	A_s	[mm ²]	26.9	42.4	61.5	109.3
Elastic section modulus	W_{el}	[mm ³]	31.2	62.3	109.2	277.5
Characteristic bending resistance	$M_{0,sk}$	[Nm]	22	45	79	200
Design bending resistance	M	[Nm]	17.6	36	63.2	160

BASIC PERFORMANCE DATA

Performance data for single anchor without influence of edge distance and spacing

Size		M8	M10	M12	M16
Effective embedment depth	h_{ef}	47.00	50.00	68.00	85.00
MEAN ULTIMATE LOAD					
TENSION LOAD $N_{Rk,m}$	[kN]	16.03	18.20	32.76	42.13
SHEAR LOAD $V_{Rk,m}$	[kN]	12.10	19.14	27.83	51.81
CHARACTERISTIC LOAD					
TENSION LOAD N_{Rk}	[kN]	13.00	15.00	25.00	34.00
SHEAR LOAD V_{Rk}	[kN]	11.00	17.39	25.30	47.10
DESIGN LOAD					
TENSION LOAD N_{Rd}	[kN]	8.67	10.00	16.67	22.67
SHEAR LOAD V_{Rd}	[kN]	8.80	11.60	20.24	37.68

DESIGN PERFORMANCE DATA

Size		M8	M10	M12	M16	
Effective embedment depth	h_{ef}	[mm]	47.00	50.00	68.00	85.00
TENSION LOAD						
STEEL FAILURE						
Characteristic resistance	$N_{Rk,s}$	[kN]	17.50	27.60	40.00	71.00
Partial safety factor	γ_{Ms}	-	1.50	1.50	1.50	1.50
PULL-OUT FAILURE; NON-CRACKED CONCRETE C20/25						
Characteristic resistance	$N_{Rk,p}$	[kN]	13.00	15.00	25.00	34.00
PULL-OUT FAILURE						
Installation safety factor	γ_{inst}	-	1.00	1.00	1.00	1.00
Increasing factors for $N_{Rk,p}$ - C30/37	ψ_c	-	1.12	1.08	1.17	1.22
Increasing factors for $N_{Rk,p}$ - C40/50	ψ_c	-	1.23	1.15	1.32	1.41
Increasing factors for $N_{Rk,p}$ - C50/60	ψ_c	-	1.30	1.19	1.42	1.55
CONCRETE CONE FAILURE						
Factor for non-cracked concrete	$k_{cc,N}$	-	11.00	11.00	11.00	11.00
Installation safety factor	γ_{inst}	-	1.00	1.00	1.00	1.00
Spacing	$s_{cr,N}$	[mm]	141	150	204	255
Edge distance	$c_{cr,N}$	[mm]	71	75	102	128
CONCRETE SPLITTING FAILURE						
Spacing	$s_{cr,sp}$	[mm]	240	260	340	430
Edge distance	$c_{cr,sp}$	[mm]	120	130	170	215
Installation safety factor	γ_{inst}	-	1.00	1.00	1.00	1.00
SHEAR LOAD						
STEEL FAILURE						
Characteristic resistance without lever arm	$V_{Rk,s}$	[kN]	11.00	17.40	25.30	47.10
Ductility factor	k_{ψ}	-	1.00	1.00	1.00	1.00
Characteristic resistance with lever arm	$M_{Rk,s}$	[Nm]	22.00	45.00	79.00	200.00
Partial safety factor	γ_{Ms}	-	1.25	1.25	1.25	1.25
CONCRETE PRY-OUT FAILURE						
Factor	k	-	1.00	1.00	2.00	2.00
Installation safety factor	γ_{inst}	-	1.00	1.00	1.00	1.00
CONCRETE EDGE FAILURE						
Effective length of anchor	ℓ_f	[mm]	47	50	68	85
Anchor diameter	d_{nom}	[mm]	8	10	12	16
Installation safety factor	γ_{inst}	-	1.00	1.00	1.00	1.00

R-XPT THROUGH BOLT

Throughbolt for non-cracked concrete



FEATURES AND BENEFITS

- High performance in non-cracked concrete confirmed by ETA Option 7
- High quality with cost effectiveness
- Suitable for reduced embedment to avoid contact with reinforcement
- Embedment depth markings help to ensure precise installation of the anchor
- Design allows drilling and installing directly through the fixture and helps to reduce installation effort
- Cold formed body ensures consistent dimensional accuracy
- Simple through-installation (drilling and installation through fixed material)
- Optimized expander design with six grip features allows for a high load-bearing capacity

APPLICATIONS

- Cladding restraint
- Curtain wall
- Balustrading
- Barriers
- Handrails
- Racking
- Structural steel
- Bollards

BASE MATERIALS

- Approved for use in:
- Non-cracked concrete C20/25-C50/60
 - Unreinforced concrete
- Also suitable for use in:
- Natural Stone (after site testing)

INSTALLATION GUIDE



- Drill a hole of required diameter and depth
- Clear the hole of drilling dust and debris (using blowpump or equivalent method)
- Lightly tap the throughbolt through the fixture into hole with a hammer, until fixing depth is reached
- Tighten to the recommended torque

PRODUCT INFORMATION

Size	Product Code	Anchor		Fixture		
		Diameter d [mm]	Length L [mm]	Max. thickness t_{fix} for: $h_{nom,red}$ $h_{nom,std}$ [mm] [mm]		Hole diameter d_f [mm]
M6	R-XPT-06050/10	6	50	10	-	7
	R-XPT-06065/5	6	65	25	5	7
	R-XPT-06085/25	6	85	45	25	7
	R-XPT-06100/40	6	100	60	40	7
M8	R-XPT-08050/5	8	50	5	-	9
	R-XPT-08060/10	8	60	10	-	9
	R-XPT-08065/15	8	65	15	-	9
	R-XPT-08075/10	8	75	25	10	9
	R-XPT-08080/15	8	80	30	15	9
	R-XPT-08085/20	8	85	35	20	9
	R-XPT-08095/30	8	95	45	30	9
	R-XPT-08115/50	8	115	65	50	9
M10	R-XPT-08140/75	8	140	90	75	9
	R-XPT-08150/85	8	150	100	85	9
	R-XPT-10065/5	10	65	5	-	11
	R-XPT-10080/10	10	80	20	10	11
	R-XPT-10095/25	10	95	35	25	11
	R-XPT-10115/45	10	115	55	45	11
	R-XPT-10130/60	10	130	70	60	11
	R-XPT-10140/70	10	140	80	70	11
M12	R-XPT-10150/80	10	150	90	80	11
	R-XPT-10180/110	10	180	120	110	11

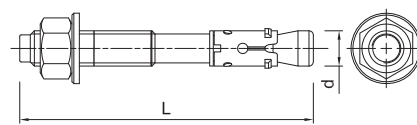

R-XPT THROUGH BOLT

PRODUCT INFORMATION (cont.)

Size	Product Code	Anchor		Fixture		
		Diameter d [mm]	Length L [mm]	Max. thickness t_{fix} for: $h_{nom,red}$ $h_{nom,std}$ [mm] [mm]		Hole diameter d_f [mm]
M12	R-XPT-12080/5	12	80	5	-	13
	R-XPT-12100/5	12	100	25	5	13
	R-XPT-12120/25	12	120	45	25	13
	R-XPT-12125/30	12	125	50	30	13
	R-XPT-12135/40	12	135	60	40	13
	R-XPT-12140/45	12	140	65	45	13
	R-XPT-12150/55	12	150	75	55	13
	R-XPT-12160/65	12	160	85	65	13
	R-XPT-12180/85	12	180	105	85	13
	R-XPT-12200/105	12	200	125	105	13
	R-XPT-12220/125	12	220	145	125	13
	R-XPT-12250/155	12	250	175	155	13
M16	R-XPT-12280/185	12	280	205	185	13
	R-XPT-16090/10	16	90	0	0	18
	R-XPT-16100/5	16	100	5	-	18
	R-XPT-16105/10	16	105	10	-	18
	R-XPT-16125/5	16	125	25	5	18
	R-XPT-16140/20	16	140	40	20	18
	R-XPT-16150/30	16	150	50	30	18
	R-XPT-16160/40	16	160	60	40	18
	R-XPT-16180/60	16	180	80	60	18
	R-XPT-16200/80	16	200	100	80	18
	R-XPT-16220/100	16	220	120	100	18
	R-XPT-16250/130	16	250	150	130	18
M20	R-XPT-16280/160	16	280	180	160	18
	R-XPT-16300/180	16	300	200	180	18
	R-XPT-20125/5	20	125	5	-	22
	R-XPT-20160/20	20	160	40	20	22
	R-XPT-20200/60	20	200	80	60	22
	R-XPT-20250/110	20	250	130	110	22
M24	R-XPT-20300/160	20	300	180	160	22
	R-XPT-24180/20	24	180	35	20	26
M24	R-XPT-24260/100	24	260	115	100	26
	R-XPT-24300/140	24	300	155	140	26

* Not covered by ETA

INSTALLATION DATA

Size		M6	M8	M10	M12	M16	M20	M24	
Thread diameter	d	[mm]	6	8	10	12	16	20	24
Hole diameter in substrate	d_o	[mm]	6	8	10	12	16	20	24
Installation torque	T_{inst}	[Nm]	5	15	30	50	100	200	300
Wrench size	Sw	[mm]	10	13	17	19	24	30	36
External diameter of washer		[mm]	12	16	20	24	30	37	44
STANDARD EMBEDMENT DEPTH									
Min. hole depth in substrate	$h_{0,s}$	[mm]	55	65	69	90	110	129	140
Min. installation depth	$h_{nom,s}$	[mm]	50	55	59	80	100	119	135
Min. substrate thickness	$h_{min,s}$	[mm]	84	100	100	136	170	198	224
Min. spacing	$s_{min,s}$	[mm]	45	50	55	75	90	140	180
Min. edge distance	$c_{min,s}$	[mm]	50	40	50	65	80	100	200
REDUCED EMBEDMENT DEPTH									
Min. hole depth in substrate	$h_{0,r}$	[mm]	35	50	59	70	90	110	125
Min. installation depth	$h_{nom,r}$	[mm]	30	40	49	60	80	100	120
Min. substrate thickness	$h_{min,r}$	[mm]	80	100	100	100	130	158	194
Min. spacing	$s_{min,r}$	[mm]	40	45	55	100	100	125	160
Min. edge distance	$c_{min,r}$	[mm]	45	40	65	100	100	125	160

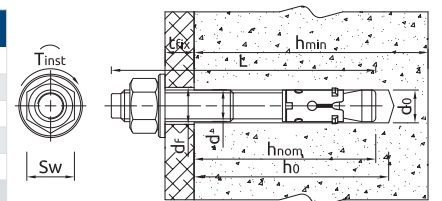

MECHANICAL PROPERTIES

Size		M6	M8	M10	M12	M16	M20	M24
Nominal ultimate tensile strength - tension	f_{uk}	[N/mm ²]	600	600	600	600	600	600
Nominal yield strength - tension	f_{yk}	[N/mm ²]	480	480	480	480	480	480
Cross sectional area - tension	A_s	[mm ²]	14.25	25.5	40.7	60.1	106.6	234.52
Elastic section modulus	W_{el}	[mm ³]	13.15	31.2	62.3	109	276.4	539.9
Characteristic bending resistance	$M_{Rk,s}^0$	[Nm]	7	17	35	61	154	301
Design bending resistance	M	[Nm]	5.6	13.6	28	48.8	123.2	240.8

R-XPT THROUGH BOLT

BASIC PERFORMANCE DATA

Performance data for single anchor without influence of edge distance and spacing

Size		M6	M8	M10	M12	M16	M20	M24							
Effective embedment depth	h_{ef}	22	42	32	47	39	49	48	68	65	85	79	99	97	112
MEAN ULTIMATE LOAD															
TENSION LOAD $N_{Ru,m}$															
Standard embedment depth	[kN]	8.70	18.10	19.80	28.00	49.70	65.30	67.60							
Reduced embedment depth	[kN]	5.70	10.90	11.40	21.50	37.00	45.50	62.70							
SHEAR LOAD $V_{Ru,m}$															
Standard embedment depth	[kN]	6.00	12.20	19.20	28.00	51.50	80.90	118.60							
Reduced embedment depth	[kN]	6.00	12.20	16.44	22.45	51.50	74.14	115.20							
CHARACTERISTIC LOAD															
TENSION LOAD N_{Rk}															
Standard embedment depth	[kN]	8.67	12.00	15.00	24.00	38.55	44.00	38.14							
Reduced embedment depth	[kN]	4.27	8.90	9.00	16.00	25.78	34.54	31.92							
SHEAR LOAD V_{Rk}															
Standard embedment depth	[kN]	5.50	11.00	16.87	25.30	47.10	73.50	97.10							
Reduced embedment depth	[kN]	5.50	8.90	11.98	16.36	47.10	69.08	93.99							
DESIGN LOAD															
TENSION LOAD N_{Rd}															
Standard embedment depth	[kN]	3.44	8.00	10.00	16.00	25.70	29.33	15.13							
Reduced embedment depth	[kN]	1.69	5.94	6.00	10.67	17.19	23.03	12.67							
SHEAR LOAD V_{Rd}															
Standard embedment depth	[kN]	4.40	8.80	11.25	20.24	37.68	58.80	77.68							
Reduced embedment depth	[kN]	3.38	5.94	7.99	10.91	34.37	46.06	62.66							

DESIGN PERFORMANCE DATA

(-) failure is not decisive

Size		M6	M8	M10	M12	M16	M20	M24							
Effective embedment depth	h_{ef} [mm]	22	42	32	47	39	49	48	68	65	85	79	99	97	112
TENSION LOAD															
STEEL FAILURE															
Characteristic resistance	$N_{Rk,s}$ [kN]	8.84	8.84	17.5	17.5	27.6	27.6	40.0	40.0	71.0	71.0	108.4	108.4	145.4	145.4
Partial safety factor	γ_{Ms}	-	1.4	1.4	1.5	1.5	1.5	1.5	1.5	1.5	1.5	1.5	1.5	1.4	1.4
PULL-OUT FAILURE; NON-CRACKED CONCRETE C20/25															
Characteristic resistance	$N_{Rk,p}$ [kN]	4.27	8.67	9.0	12.0	9.0	15.0	16.0	24.0	28.0	40.0	36.0	44.0	31.92	38.14
PULL-OUT FAILURE															
Installation safety factor	γ_{inst}	-	1.68	1.68	1.0	1.0	1.0	1.0	1.0	1.0	1.0	1.0	1.0	1.68	1.68
Increasing factors for $N_{Rd,p}$ - C30/37	ψ_c	-	1.00	1.00	1.23	1.16	1.23	1.23	1.21	1.23	1.23	1.23	1.23	1.00	1.00
Increasing factors for $N_{Rd,p}$ - C40/50	ψ_c	-	1.00	1.00	1.43	1.28	1.43	1.43	1.39	1.43	1.43	1.43	1.43	1.00	1.00
Increasing factors for $N_{Rd,p}$ - C50/60	ψ_c	-	1.00	1.00	1.58	1.4	1.58	1.58	1.52	1.58	1.58	1.58	1.58	1.00	1.00
CONCRETE CONE FAILURE															
Factor for non-cracked concrete	$k_{occ,N}$	-	11.0	11.0	11.0	11.0	11.0	11.0	11.0	11.0	11.0	11.0	11.0	11.0	11.0
Installation safety factor	γ_{inst}	-	1.68	1.68	1.0	1.0	1.0	1.0	1.0	1.0	1.0	1.0	1.0	1.68	1.68
Spacing	$s_{cr,N}$ [mm]	66	126	96	141	117	147	144	204	195	255	237	297	291	336
Edge distance	$c_{cr,N}$ [mm]	33	63	48	71	59	74	72	102	98	128	119	149	156	168
CONCRETE SPLITTING FAILURE															
Spacing	$s_{cr,sp}$ [mm]	110	210	160	240	200	260	250	370	360	430	410	530	500	580
Edge distance	$c_{cr,sp}$ [mm]	55	105	80	120	100	130	125	185	180	215	205	265	250	290
Installation safety factor	γ_{inst}	-	1.68	1.68	1.0	1.0	1.0	1.0	1.0	1.0	1.0	1.0	1.0	1.68	1.68
SHEAR LOAD															
STEEL FAILURE															
Characteristic resistance without lever arm	$V_{Rk,s}$ [kN]	5.5	5.5	11.0	11.0	17.4	17.4	25.3	25.3	47.1	47.1	73.5	73.5	97.1	97.1
Ductility factor	k_{γ}	-	0.80	0.80	1.0	1.0	1.0	1.0	1.0	1.0	1.0	1.0	1.0	0.80	0.80
Characteristic resistance with lever arm	$M_{Rk,s}$ [Nm]	7.34	7.34	22.0	22.0	45.0	45.0	79.0	79.0	200.0	200.0	392.0	392.0	525.0	525.0
Partial safety factor	γ_{Ms}	-	1.25	1.25	1.25	1.25	1.25	1.25	1.25	1.25	1.25	1.25	1.25	1.25	1.25
CONCRETE PRY-OUT FAILURE															
Factor	k	-	1.00	1.00	1.00	1.00	1.00	1.00	2.00	2.00	2.00	2.00	2.00	2.00	2.00
Installation safety factor	γ_{inst}	-	1.00	1.00	1.00	1.00	1.00	1.00	1.00	1.00	1.00	1.00	1.00	1.00	1.00
CONCRETE EDGE FAILURE															
Effective length of anchor	ℓ_f [mm]	22	42	32	47	39	49	48	68	65	85	79	99	97	112
Anchor diameter	d_{nom} [mm]	6	6	8	8	10	10	12	12	16	16	20	20	24	24
Installation safety factor	γ_{inst}	-	1.00	1.00	1.00	1.00	1.00	1.00	1.00	1.00	1.00	1.00	1.00	1.00	1.00

The use of the reduced embedment depth M8 and M10 is restricted to anchoring statically indeterminate structural components.

R-RB Rawlbolt® FOR USE IN CRACKED AND NON-CRACKED CONCRETE

World's most popular all-purpose expanding shield anchor - loose bolt version



Loose bolt
R-RBL Rawlbolt®

Bolt projecting
R-RBP Rawlbolt®



FEATURES AND BENEFITS

- RAWLBOLT® - first ever mechanical anchor in the world, forerunner of all of the later mechanical anchors
- For use in cracked and non-cracked concrete (ETA option 1), hollow-core slabs, flooring blocks and ceramics
- Product recommended for applications requiring fire resistance
- Three-pieces expanding sleeve of maximum expansion provides optimal load and safety of use in any substrate
- Wide range of diameters (M6 to M20)

APPLICATIONS

- Roller shutter doors
- Fire doors
- Structural steelwork
- Security grills
- Heavy machinery
- Pipework/ductwork supports

BASE MATERIALS

- Approved for use in:
 - Cracked concrete C20/25-C50/60
 - Non-cracked concrete C20/25-C50/60
 - Unreinforced concrete
 - Reinforced concrete
- Also suitable for use in:
 - Solid clay brick $\geq 20\text{MPa}$
 - Hollow Lightweight Concrete Block LAC $5 \geq 5\text{MPa}$
 - Hollow Sand-lime Brick $\geq 15\text{MPa}$
 - Concrete hollow floor block (eg. Teriva)
 - Hollow-core Slab C20/25
 - Hollow-core Slab C30/37-C50/60
 - Natural Stone (after site testing)

INSTALLATION GUIDE



- Drill a hole of required diameter and depth. Note: When fixing into brickwork, mortar joints should be avoided
- Clear the hole of drilling dust and debris (using blowpump or equivalent method)



- Remove pre-assembled bolt and washer. Insert shield into hole and tap home with hammer until flush with surface
- Insert bolt with washer through fixture into the shield
- Tighten to the recommended torque

R-RB Rawlbolt® FOR USE IN CRACKED AND NON-CRACKED CONCRETE

PRODUCT INFORMATION

R-RBL Rawlbolt® LOOSE BOLT

Size	Product Code	Anchor			Fixture	
		Diameter	External diameter	Length	Max. thickness	Hole diameter
		d [mm]	d _{nom} [mm]	L [mm]	t _{fix} [mm]	d _i [mm]
M6	R-RBL-M06/10W	6	12	55	10	6.5
	R-RBL-M06/25W	6	12	70	25	6.5
	R-RBL-M06/40W	6	12	85	40	6.5
M8	R-RBL-M08/10W	8	14	65	10	9
	R-RBL-M08/25W	8	14	80	25	9
	R-RBL-M08/40W	8	14	95	40	9
M10	R-RBL-M10/10W	10	16	75	10	11
	R-RBL-M10/25W	10	16	90	25	11
	R-RBL-M10/50W	10	16	115	50	11
M12	R-RBL-M12/10W	12	20	90	10	13
	R-RBL-M12/25W	12	20	105	25	13
	R-RBL-M12/40W	12	20	120	40	13
M16	R-RBL-M16/15W	16	25	135	15	17
	R-RBL-M16/30W	16	25	150	30	17
	R-RBL-M16/60W	16	25	180	60	17
M20	R-RBL-M20/60W	20	32	195	60	22
	R-RBL-M20/100W	20	32	235	110	22

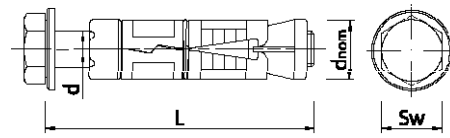

R-RBP Rawlbolt® BOLT PROJECTING

Size	Product Code	Anchor			Fixture	
		Diameter	External diameter	Length	Max. thickness	Hole diameter
		d [mm]	d _{nom} [mm]	L [mm]	t _{fix} [mm]	d _i [mm]
M6	R-RBP-M06/10W	6	12	65	10	6.5
	R-RBP-M06/25W	6	12	80	25	6.5
	R-RBP-M06/60W	6	12	115	60	6.5
M8	R-RBP-M08/10W	8	14	75	10	9
	R-RBP-M08/25W	8	14	90	25	9
	R-RBP-M08/60W	8	14	125	60	9
M10	R-RBP-M10/15W	10	16	90	15	11
	R-RBP-M10/30W	10	16	105	30	11
	R-RBP-M10/60W	10	16	135	60	11
M12	R-RBP-M12/15W	12	20	110	15	13
	R-RBP-M12/30W	12	20	125	30	13
	R-RBP-M12/75W	12	20	170	75	13
M16	R-RBP-M16/15W	16	25	150	15	17
	R-RBP-M16/35W	16	25	170	35	17
	R-RBP-M16/75W	16	25	210	75	17
M20	R-RBP-M20/15W	20	32	170	15	22
	R-RBP-M20/30W	20	32	185	30	22
	R-RBP-M20/100W	20	32	255	100	22

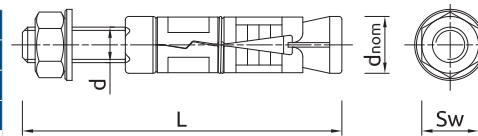

R-RB Rawlbolt® FOR USE IN CRACKED AND NON-CRACKED CONCRETE

INSTALLATION DATA

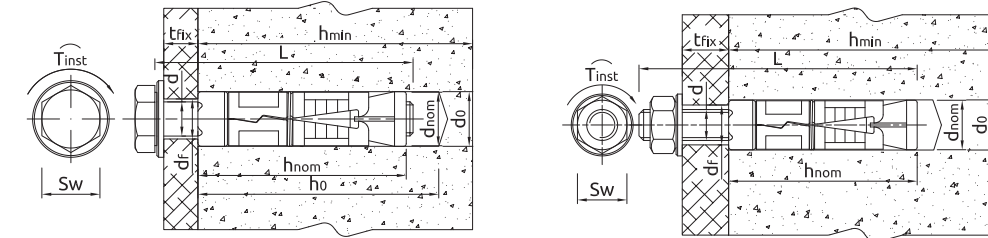

Size		M6	M8	M10	M12	M16	M20	
Thread diameter	d	[mm]	6	8	10	12	16	20
Hole diameter in substrate	d _o	[mm]	12	14	16	20	25	32
Installation torque	T _{inst}	[Nm]	6.5	15	27	50	120	230
Wrench size	Sw	[mm]	10	13	17	19	24	30
Min. hole depth in substrate	h _o	[mm]	50	55	65	85	125	140
Min. installation depth	h _{nom}	[mm]	45	50	60	80	120	135
Min. substrate thickness	h _{min}	[mm]	100	100	100	100	142.5	172.5
Min. spacing	s _{min}	[mm]	35	40	50	60	95	115
Min. edge distance	c _{min}	[mm]	53	60	75	90	143	173

MECHANICAL PROPERTIES

Size		M6	M8	M10	M12	M16	M20	
Nominal ultimate tensile strength - tension	F _{uk}	[N/mm ²]	500	500	500	500	500	
Nominal yield strength - tension	F _{yk}	[N/mm ²]	400	400	400	400	400	
Cross sectional area - tension	A _s	[mm ²]	20.1	36.6	58	84.3	157	245
Elastic section modulus	W _{el}	[mm ³]	21.21	50.27	98.17	169.65	402.12	785.4
Characteristic bending resistance	M ² _{yk,s}	[Nm]	12.72	30.16	58.9	101.79	241.27	471.24
Design bending resistance	M	[Nm]	10.18	24.13	47.12	81.43	193.02	376.99

BASIC PERFORMANCE DATA

Performance data for single anchor without influence of edge distance and spacing

Size		M6	M8	M10	M12	M16	M20	M24
NON-CRACKED CONCRETE								
Effective embedment depth h _{ef}	[mm]	35.00	40.00	50.00	60.00	95.00	115.00	125.00
CRACKED CONCRETE								
Effective embedment depth h _{ef}	[mm]	35.00	40.00	50.00	60.00	95.00	115.00	125.00
MEAN ULTIMATE LOAD								
TENSION LOAD N_{Rk,m}								
NON-CRACKED CONCRETE	[kN]	7.80	8.35	15.24	18.48	48.77	56.55	94.33
CRACKED CONCRETE	[kN]	5.20	6.50	7.80	15.60	20.80	34.16	66.38
SHEAR LOAD V_{Rk,m}								
NON-CRACKED CONCRETE	[kN]	5.53	10.07	15.95	23.19	43.18	67.38	97.13
CRACKED CONCRETE	[kN]	5.53	10.07	15.95	23.19	43.18	67.38	97.13
CHARACTERISTIC LOAD								
TENSION LOAD N_{Rk}								
NON-CRACKED CONCRETE	[kN]	6.00	7.50	12.00	16.00	40.00	50.00	68.75
CRACKED CONCRETE	[kN]	4.00	5.00	6.00	12.00	16.00	30.00	48.13
SHEAR LOAD V_{Rk}								
NON-CRACKED CONCRETE	[kN]	5.03	9.15	14.50	21.08	39.25	61.25	88.30
CRACKED CONCRETE	[kN]	5.03	8.71	12.17	21.08	39.25	61.25	88.30
DESIGN LOAD								
TENSION LOAD N_{Rd}								
NON-CRACKED CONCRETE	[kN]	3.33	4.17	6.67	8.89	22.22	27.78	32.74
CRACKED CONCRETE	[kN]	2.22	2.78	3.33	6.67	8.89	16.67	22.92
SHEAR LOAD V_{Rd}								
NON-CRACKED CONCRETE	[kN]	4.02	7.32	11.60	16.86	31.40	49.00	70.64
CRACKED CONCRETE	[kN]	4.02	5.81	8.12	16.86	31.40	49.00	64.17

R-RB Rawlbolt® FOR USE IN CRACKED AND NON-CRACKED CONCRETE

DESIGN PERFORMANCE DATA

Size			M6	M8	M10	M12	M16	M20
Effective embedment depth	h_{ef}	[mm]	35	40	50	60	95	115
TENSION LOAD								
STEEL FAILURE								
Characteristic resistance	$N_{Rk,s}$	[kN]	10.05	18.30	29.00	42.15	78.50	122.50
Partial safety factor	γ_{Ms}	-	1.50	1.50	1.50	1.50	1.50	1.50
PULL-OUT FAILURE; NON-CRACKED CONCRETE C20/25								
Characteristic resistance	$N_{Rk,p}$	[kN]	6.00	7.50	12.00	16.00	40.00	50.00
PULL-OUT FAILURE; CRACKED CONCRETE C20/25								
Characteristic resistance	$N_{Rk,p}$	[kN]	4.00	5.00	6.00	12.00	16.00	30.00
PULL-OUT FAILURE								
Installation safety factor	γ_2	-	1.20	1.20	1.20	1.20	1.20	1.20
Increasing factors for $N_{Rk,p}$ - C30/37	ψ_c	-	1.22	1.22	1.22	1.22	1.22	1.22
Increasing factors for $N_{Rk,p}$ - C40/50	ψ_c	-	1.41	1.41	1.41	1.41	1.41	1.41
Increasing factors for $N_{Rk,p}$ - C50/60	ψ_c	-	1.55	1.55	1.55	1.55	1.55	1.55
CONCRETE CONE FAILURE								
Factor for cracked concrete	$k_{cr,N}$	-	7.70	7.70	7.70	7.70	7.70	7.70
Factor for non-cracked concrete	$k_{ucr,N}$	-	11.00	11.00	11.00	11.00	11.00	11.00
Installation safety factor	γ_2	-	1.20	1.20	1.20	1.20	1.20	1.20
Spacing	$s_{cr,N}$	[mm]	105	120	150	180	285	345
Edge distance	$c_{cr,N}$	[mm]	52	60	75	90	143	173
CONCRETE SPLITTING FAILURE								
Spacing	$s_{cr,sp}$	[mm]	105	120	150	180	285	345
Edge distance	$c_{cr,sp}$	[mm]	53	60	75	90	143	173
Installation safety factor	γ_2	-	1.20	1.20	1.20	1.20	1.20	1.20
STEEL FAILURE								
Characteristic resistance without lever arm	$V_{Rk,s}$	[kN]	5.03	9.15	14.50	21.08	39.25	61.25
Ductility factor	k_f	-	0.80	0.80	0.80	0.80	0.80	0.80
Characteristic resistance with lever arm	$M_{Rk,s}$	[Nm]	7.63	18.74	37.39	65.52	166.52	324.62
Partial safety factor	γ_{Ms}	-	1.25	1.25	1.25	1.25	1.25	1.25
CONCRETE PRY-OUT FAILURE								
Factor	k	-	1.00	1.00	1.00	2.00	2.00	2.00
Installation safety factor	γ_2	-	1.00	1.00	1.00	1.00	1.00	1.00
CONCRETE EDGE FAILURE								
Effective length of anchor	ℓ_f	[mm]	35	40	50	60	95	115
Anchor diameter	d_{nom}	[mm]	6	8	10	12	16	20
Installation safety factor	γ_2	-	1.00	1.00	1.00	1.00	1.00	1.00

Resistance to tension and shear loads under fire exposure

Size			M6	M8	M10	M12	M16	M20
Effective embedment depth	h_{ef}	[mm]	35	40	50	60	95	115
R (for EI) = 30 min								
TENSION LOAD								
STEEL FAILURE								
Characteristic resistance	$N_{Rk,s}$	[kN]	0.20	0.40	0.90	1.70	3.10	4.90
PULL-OUT FAILURE								
Characteristic resistance	$N_{Rk,p}$	[kN]	1.00	1.30	1.50	3.00	4.00	7.50
SHEAR LOAD								
STEEL FAILURE								
Characteristic resistance without lever arm	$V_{Rk,s}$	[kN]	0.20	0.40	0.90	1.70	3.10	4.90
Characteristic resistance with lever arm	$M_{Rk,s}$	[kN]	0.20	0.40	1.10	2.60	6.70	13.00
R (for EI) = 60 min								
TENSION LOAD								
STEEL FAILURE								
Characteristic resistance	$N_{Rk,s}$	[kN]	0.20	0.30	0.80	1.30	2.40	3.70
PULL-OUT FAILURE								
Characteristic resistance	$N_{Rk,p}$	[kN]	1.00	1.30	1.50	3.00	4.00	7.50
SHEAR LOAD								
STEEL FAILURE								
Characteristic resistance without lever arm	$V_{Rk,s}$	[kN]	0.20	0.30	0.80	1.30	2.40	3.70
Characteristic resistance with lever arm	$M_{Rk,s}$	[kN]	0.10	0.30	1.00	2.00	5.00	9.70

R-RB Rawlbolt® FOR USE IN CRACKED AND NON-CRACKED CONCRETE

DESIGN PERFORMANCE DATA

Size			M6	M8	M10	M12	M16	M20
R (for EI) = 90 min								
TENSION LOAD								
STEEL FAILURE								
Characteristic resistance	$N_{Rk,s}$	[kN]	0.10	0.30	0.60	1.10	2.00	3.20
PULL-OUT FAILURE								
Characteristic resistance	$N_{Rk,p}$	[kN]	1.00	1.30	1.50	3.00	4.00	7.50
SHEAR LOAD								
STEEL FAILURE								
Characteristic resistance without lever arm	$V_{Rk,s}$	[kN]	0.10	0.30	0.60	1.10	2.00	3.20
Characteristic resistance with lever arm	$M_{Rk,s}$	[kN]	0.10	0.30	0.70	1.70	4.30	8.40
R (for EI) = 120 min								
TENSION LOAD								
STEEL FAILURE								
Characteristic resistance	$N_{Rk,s}$	[kN]	0.10	0.20	0.50	0.80	1.60	2.50
PULL-OUT FAILURE								
Characteristic resistance	$N_{Rk,p}$	[kN]	0.80	1.00	1.20	2.40	3.20	6.00
SHEAR LOAD								
STEEL FAILURE								
Characteristic resistance without lever arm	$V_{Rk,s}$	[kN]	0.10	0.20	0.50	0.80	1.60	2.50
Characteristic resistance with lever arm	$M_{Rk,s}$	[kN]	0.10	0.20	0.60	1.30	3.30	6.50

R-SPL SafetyPlus HEAVY DUTY EXPANSION ANCHORS

High performance mechanical anchor - loose bolt option



Loose Bolt
R-SPL SafetyPlus

Bolt Projecting
R-SPL-BP SafetyPlus

Countersunk
R-SPL-C SafetyPlus



FEATURES AND BENEFITS

- High performance in non-cracked concrete confirmed by ETA Option 7
- Design of SafetyPlus allows for easy through fixing
- Integral controlled collapse and anti-rotation feature ensures fixture is firmly secured
- Unique zig-zag feature provides balanced expansion, ensuring secure setting and maximised load-bearing capacity
- Case-hardened nut with optimum taper angle for enhanced expansion
- Fire resistant

APPLICATIONS

- Structural steel
- Masonry support
- Cladding restraint
- Road Signs
- Heavy machinery
- Racking systems
- Industrial doors
- Safety barriers

BASE MATERIALS

- Approved for use in:
- Non-cracked concrete C20/25-C50/60
 - Unreinforced concrete
 - Reinforced concrete
 - Natural Stone (after site testing)

INSTALLATION GUIDE



- Drill the hole with rotary percussive machine. Drill to a required depth.
- Blow out dust at least 4 times with a hand pump.



R-SPL SafetyPlus HEAVY DUTY EXPANSION ANCHORS

INSTALLATION GUIDE



- Insert anchor through fixture into hole and tap until required installation depth is achieved
- Tighten to the recommended torque

PRODUCT INFORMATION

R-SPL SafetyPlus LOOSE BOLT

Size	Product Code	Anchor			Fixture	
		Thread size	External diameter	Length	Max. thickness	Hole diameter
		d [mm]	d _{nom} [mm]	L [mm]	t _{fix} [mm]	d _f [mm]
M8	R-SPL-08090/15	8	12	90	15	14
	R-SPL-08110/40	8	12	110	40	14
M10	R-SPL-10105/20	10	15	105	20	17
	R-SPL-10120/40	10	15	120	40	17
M12	R-SPL-10140/60	10	15	140	60	17
	R-SPL-12120/25	12	18	120	25	20
M16	R-SPL-12150/50	12	18	150	50	20
	R-SPL-16145/25	16	24	145	25	26
M20	R-SPL-16170/50	16	24	170	50	26
	R-SPL-20175/30	20	28	175	30	30

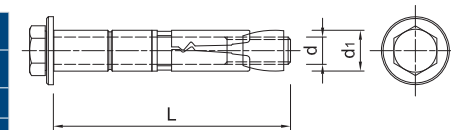

R-SPL-BP SafetyPlus BOLT PROJECTING

Size	Product Code	Anchor			Fixture	
		Thread size	External diameter	Length	Max. thickness	Hole diameter
		d [mm]	d _{nom} [mm]	L [mm]	t _{fix} [mm]	d _f [mm]
M10	R-SPL-BP-10110/20	10	15	110	20	17
M12	R-SPL-BP-12135/25	12	18	135	25	20
	R-SPL-BP-12160/50	12	18	160	50	20
M16	R-SPL-BP-16160/25	16	24	160	25	26
	R-SPL-BP-16185/50	16	24	185	50	26
M20	R-SPL-BP-20190/30	20	28	190	30	30

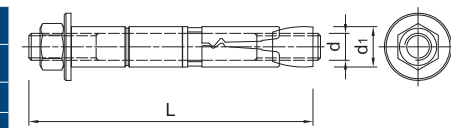

R-SPL-C SafetyPlus COUNTERSUNK

Size	Product Code	Anchor			Fixture	
		Thread size	External diameter	Length	Max. thickness	Hole diameter
		d [mm]	d _{nom} [mm]	L [mm]	t _{fix} [mm]	d _f [mm]
M8	R-SPL-C-08090/20	8	12	90	20	14
M10	R-SPL-C-10105/25	10	15	105	25	17
M12	R-SPL-C-12125/30	12	18	125	30	20
M16	R-SPL-C-16145/30	16	24	145	30	26

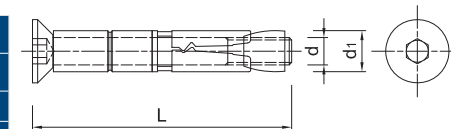

R-SPL SafetyPlus HEAVY DUTY EXPANSION ANCHORS

INSTALLATION DATA

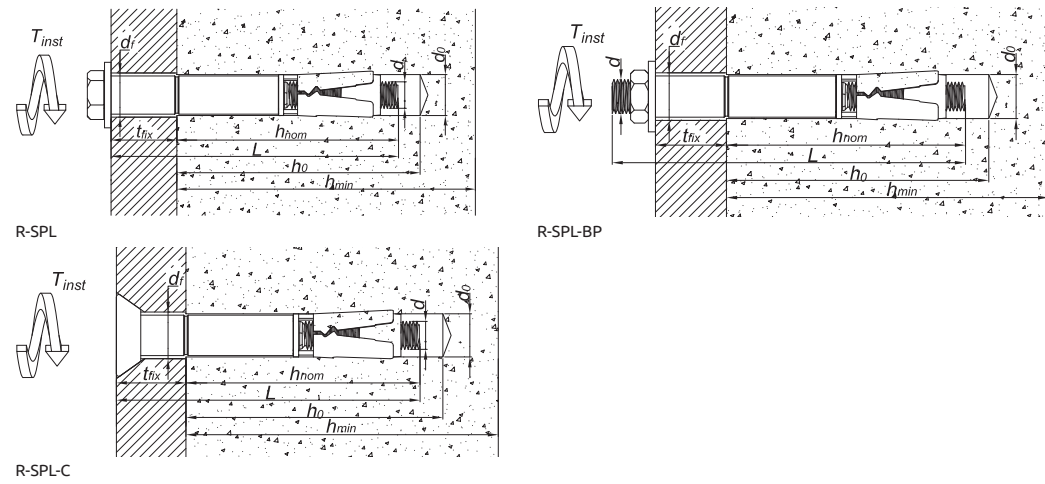

Size		M8	M10	M12	M16	M20
Thread diameter	d	8	10	12	16	20
Hole diameter in substrate	d ₀	12	15	18	24	28
Installation torque	T _{inst}	25	50	80	180	275
Wrench size R-SPL, R-SPL-BP	Sw	13	17	19	24	30
Wrench size R-SPL-C	H _{ex}	6	8	10	12	-
Min. hole depth in substrate	h ₀	85	95	105	130	160
Min. installation depth	h _{nom}	70	80	90	110	130
Min. substrate thickness	h _{min}	100	105	120	150	188
Min. spacing	s _{min}	60	70	80	100	125
Min. edge distance	c _{min}	90	105	120	150	186

MECHANICAL PROPERTIES

Size		M8	M10	M12	M16	M20
Nominal ultimate tensile strength - tension	F _{uk}	800	800	800	800	800
Nominal yield strength - tension	F _{yk}	640	640	640	640	640
Cross sectional area - tension	A _s	36.6	58	84.3	157	245
Elastic section modulus	W _{el}	50.3	98.2	169.7	402.1	785.4
Characteristic bending resistance	M ⁰ _{Rk,s}	45.04	87.97	152.01	365.97	728.54
Design bending resistance	M	36.03	70.38	121.61	292.78	592.83

BASIC PERFORMANCE DATA

Performance data for single anchor without influence of edge distance and spacing

Size		M8	M10	M12	M16	M20
Effective embedment depth h _{ef}	[mm]	60	70	80	100	125
MEAN ULTIMATE LOAD						
TENSION LOAD N _{Ru,m}	[kN]	10.84	14.46	19.28	42.17	48.19
SHEAR LOAD V _{Ru,m}	[kN]	20.28	31.68	45.62	81.95	77.81
CHARACTERISTIC LOAD						
TENSION LOAD N _{Rk}	[kN]	9.00	12.00	16.00	35.00	40.00
SHEAR LOAD V _{Rk}	[kN]	19.20	30.00	43.20	77.60	73.68
DESIGN LOAD						
TENSION LOAD N _{Rd}	[kN]	5.00	6.67	8.89	19.44	22.22
SHEAR LOAD V _{Rd}	[kN]	15.36	24.00	34.56	62.08	58.94

R-SPL SafetyPlus HEAVY DUTY EXPANSION ANCHORS

DESIGN PERFORMANCE DATA

Size		M8	M10	M12	M16	M20
Effective embedment depth	h _{ef} [mm]	60	70	80	100	125
TENSION LOAD						
STEEL FAILURE						
Characteristic resistance	N _{Rk,s} [kN]	29.30	46.40	57.40	125.60	196.00
Partial safety factor	γ _{Ms}	1.50	1.50	1.50	1.50	1.50
Design resistance V _{Rd,s} = 1.5	V _{Rd,s} [kN]	19.53	30.93	38.27	83.73	130.67
PULL-OUT FAILURE; NON-CRACKED CONCRETE C20/25						
Characteristic resistance	N _{Rk,p} [kN]	9.00	12.00	16.00	35.00	40.00
PULL-OUT FAILURE						
Installation safety factor	γ _{inst}	1.20	1.20	1.20	1.20	1.20
Increasing factors for NRd,p - C30/37	ψ _c	1.22	1.22	1.22	1.22	1.22
Increasing factors for NRd,p - C40/50	ψ _c	1.41	1.41	1.41	1.41	1.41
Increasing factors for NRd,p - C50/60	ψ _c	1.55	1.55	1.55	1.55	1.55
CONCRETE CONE FAILURE						
Installation safety factor	γ _{inst}	1.20	1.20	1.20	1.20	1.20
Factor for non-cracked concrete	k _{ucr,N}	11.00	11.00	11.00	11.00	11.00
Spacing	S _{cr,sp} [mm]	180	210	240	300	375
Edge distance	c _{cr,sp} [mm]	90	105	120	150	188
CONCRETE SPLITTING FAILURE						
Installation safety factor	γ _{inst}	1.20	1.20	1.20	1.20	1.20
Spacing	S _{cr,sp} [mm]	180	210	240	300	375
Edge distance	c _{cr,sp} [mm]	90	105	120	150	188
SHEAR LOAD						
STILL FAILURE						
Characteristic resistance without lever arm	V _{Rk,s} [kN]	19.20	30.00	43.20	77.60	73.68
Ductility factor	k _γ	0.80	0.80	0.80	0.80	0.80
Characteristic resistance with lever arm	M _{Rk,s} [Nm]	45.04	87.97	152.01	365.97	728.54
Partial safety factor	γ _{Ms}	1.25	1.25	1.25	1.25	1.25
CONCRETE PRY-OUT FAILURE						
Factor	k	2.00	2.00	2.00	2.00	2.00
Installation safety factor	γ _{inst}	1.00	1.00	1.00	1.00	1.00
CONCRETE EDGE FAILURE						
Effective length of anchor	ℓ _f [mm]	60	70	80	100	125
Anchor diameter	d _{nom} [mm]	8	10	12	16	20
Installation safety factor	γ _{inst}	1.00	1.00	1.00	1.00	1.00

R-DCA-A4 STAINLESS STEEL WEDGE ANCHOR

Internally threaded stainless steel wedge anchor for simple hammer-set installation



FEATURES AND BENEFITS

- High performance in cracked and non-cracked concrete confirmed by ETA
- Product is covered with European Technical Assessment for multi-point non-structural fixings
- Product recommended for applications requiring fire resistance
- Stainless steel material for high resistance to corrosion
- Easy to install by hammer action and manual setting tool
- Slotted sleeve and internal wedge component together facilitate easy setting and expansion
- Product was tested for construction fixing

APPLICATIONS

- Pipelines systems
- Ventilation systems
- Sprinkler systems
- Cable conduits and wires
- Gratings

BASE MATERIALS

- Approved for use in:
- Cracked concrete C20/25-C50/60
 - Non-cracked concrete C20/25-C50/60
 - Unreinforced concrete
 - Reinforced concrete

INSTALLATION GUIDE



- Drill a hole of required diameter and depth
- Clear the hole of drilling dust and debris (using blow pump and brush or equivalent method)
- Insert wedge anchor, slotted end first
- Use the setting tool to drive the internal wedge into the anchor
- Insert bolt or stud through fixture and tighten to the recommended torque

PRODUCT INFORMATION

Size	Product Code	Anchor				Fixture
		Diameter	External diameter	Length	Internal thread length	Hole diameter
		d	d _{nom}	L	l _g	d _f
		[mm]	[mm]	[mm]	[mm]	[mm]
M6	R-DCA-06-25-A4	6	8	25	11	7
M8	R-DCA-08-30-A4	8	10	30	14	9
M10	R-DCA-10-40-A4	10	12	40	19	12
M12	R-DCA-12-50-A4	12	15	50	25	14
M16	R-DCA-16-65-A4	16	20	65	28	18

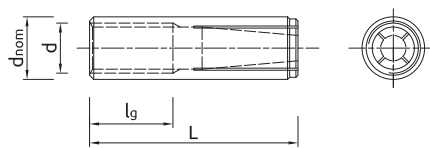

INSTALLATION DATA

Size		M6	M8	M10	M12	M16	
Thread diameter	d	[mm]	6	8	10	12	16
Hole diameter in substrate	d ₀	[mm]	8	10	12	15	20
Installation torque	T _{inst}	[Nm]	4.5	11	22	38	98
Min. hole depth in substrate	h ₀	[mm]	27	32	42	52	67
Min. installation depth	h _{nom}	[mm]	25	30	40	50	65
Min. substrate thickness	h _{min}	[mm]	80	80	80	100	130
Min. spacing	s _{min}	[mm]	200	200	200	200	260
Min. edge distance	c _{min}	[mm]	150	150	150	150	195

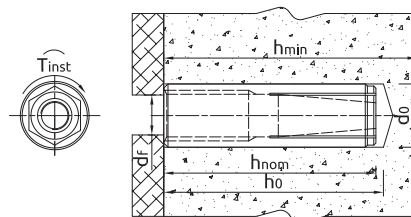

R-DCA-A4 STAINLESS STEEL WEDGE ANCHOR

MECHANICAL PROPERTIES

Size		M6	M8	M10	M12	M16	
Nominal ultimate tensile strength - tension	F _{uk}	[N/mm ²]	500	500	500	500	
Nominal yield strength - tension	F _{yk}	[N/mm ²]	210	210	210	210	
Cross sectional area - tension	A _s	[mm ²]	20.1	36.6	58	84.3	157
Elastic section modulus	W _{el}	[mm ³]	21.21	50.27	98.17	169.65	402.12

BASIC PERFORMANCE DATA

Performance data for single anchor without influence of edge distance and spacing

Size		M6	M8	M10	M12	M16
Effective embedment depth h _{ef}	[mm]	25	30	40	50	65
MEAN ULTIMATE LOAD						
TENSION AND SHEAR LOAD F _{Ru,m}	[kN]	-	-	-	-	-
CHARACTERISTIC LOAD						
TENSION AND SHEAR LOAD F _{Rk}	[kN]	1.00	2.00	3.00	4.50	8.00
DESIGN LOAD						
TENSION AND SHEAR LOAD F _{Rd}	[kN]	0.55	1.11	1.67	2.50	4.44
RECOMMENDED LOAD						
TENSION AND SHEAR LOAD F _{Rc}	[kN]	0.39	0.79	1.19	1.79	3.17

DESIGN PERFORMANCE DATA

Size		M6	M8	M10	M12	M16	
Effective embedment depth	h _{ef}	[mm]	25	30	40	50	65
TENSION AND SHEAR LOAD							
Characteristic resistance	F _{Rk}	[kN]	1.00	2.01	3.20	4.59	8.27
Installation safety factor	γ ₂	-	1.20	1.20	1.20	1.20	1.20
Spacing	s _{cr}	[mm]	200	200	200	200	260
Edge distance	c _{cr}	[mm]	150	150	150	150	195
SHEAR LOAD							
STEEL FAILURE; STEEL GRADE A4-70							
Characteristic resistance with lever arm	M _{Rk,s}	[Nm]	11.00	26.00	52.00	92.00	233.00
Partial safety factor	γ _{Ms}	-	1.25	1.25	1.25	1.25	1.25

DESIGN PERFORMANCE DATA

Characteristic Resistance under fire exposure in concrete C20/25 to C50/60

Size		M8	M10	M12	M16	
TENSION AND SHEAR LOAD						
Effective embedment depth	h _{ef}	[mm]	30	40	50	65
R (for EI) = 30 min						
TENSION AND SHEAR LOAD						
Characteristic resistance	F _{Rk}	[kN]	0.50	0.80	1.10	2.10
R (for EI) = 60 min						
TENSION AND SHEAR LOAD						
Characteristic resistance	F _{Rk}	[kN]	0.50	0.80	1.10	2.10
R (for EI) = 90 min						
TENSION AND SHEAR LOAD						
Characteristic resistance	F _{Rk}	[kN]	0.50	0.80	1.10	2.10
R (for EI) = 120 min						
TENSION AND SHEAR LOAD						
Characteristic resistance	F _{Rk}	[kN]	0.40	0.60	0.90	1.60

R-DCA WEDGE ANCHOR

Internally threaded wedge anchor for simple hammer-set installation



FEATURES AND BENEFITS

- High performance in cracked and non-cracked concrete confirmed by ETA
- Product is covered with European Technical Assessment for multi-point non-structural fixings
- Product recommended for applications requiring fire resistance
- Internally threaded to be used with threaded stud or bolt
- Easy to install by hammer action and manual setting tool
- Slotted sleeve and internal wedge component together facilitate easy setting and expansion
- Product was tested for construction fixing

APPLICATIONS

- Pipelines systems
- Ventilation systems
- Sprinkler systems
- Cable conduits and wires
- Gratings

BASE MATERIALS

- Approved for use in:
- Cracked concrete C20/25-C50/60
 - Non-cracked concrete C20/25-C50/60
 - Unreinforced concrete
 - Reinforced concrete

INSTALLATION GUIDE



- Drill a hole of required diameter and depth
- Clear the hole of drilling dust and debris (using blowpump or equivalent method)
- Insert wedge anchor, slotted end first
- Use the setting tool to drive the internal wedge into the anchor
- Insert bolt or stud through fixture and tighten to the recommended torque

PRODUCT INFORMATION

Size	Product Code	Anchor				Fixture Hole diameter d _f [mm]
		Diameter d [mm]	External diameter d _{nom} [mm]	Length L [mm]	Internal thread length l _g [mm]	
M6	R-DCA-06-25	6	8	25	11	7
	R-DCA-06-25-100B	6	8	25	11	7
M8	R-DCA-08-30	8	10	30	14	9
	R-DCA-08-30-100B	8	10	30	14	9
M10	R-DCA-10-40	10	12	40	19	12
	R-DCA-10-40-50B	10	12	40	19	12
M12	R-DCA-12-50	12	15	50	25	14
	R-DCA-12-50-30B	12	15	50	25	14
M16	R-DCA-16-65	16	20	65	28	18
	R-DCA-16-65-15B	16	20	65	28	18
M20	R-DCA-20-80	20	25	80	38	22

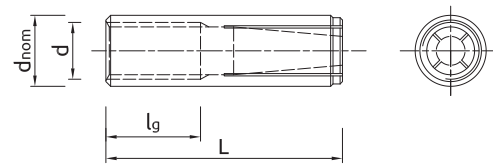

INSTALLATION DATA

Size	M6	M8	M10	M12	M16	M20		
Thread diameter	d	[mm]	6	8	10	12	16	20
Hole diameter in substrate	d _o	[mm]	8	10	12	15	20	25
Max. installation torque	T _{inst}	[Nm]	4.5	11	22	38	98	130
Min. hole depth in substrate	h _o	[mm]	27	32	42	52	67	82
Min. installation depth	h _{nom}	[mm]	25	30	40	50	65	80
Min. substrate thickness	h _{min}	[mm]	80	80	80	100	130	160
Min. spacing	s _{min}	[mm]	200	200	200	200	260	320
Min. edge distance	c _{min}	[mm]	150	150	150	150	195	240

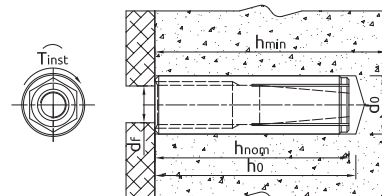

R-DCA WEDGE ANCHOR

MECHANICAL PROPERTIES

Size	M6	M8	M10	M12	M16	M20		
Nominal ultimate tensile strength - tension	f _{uk}	[N/mm ²]	450	450	450	450	450	
Nominal yield strength - tension	f _{yk}	[N/mm ²]	360	360	360	360	360	
Cross sectional area - tension	A _s	[mm ²]	20.1	36.6	58	84.3	157	245
Elastic section modulus	W _{el}	[mm ³]	21.21	50.3	98.2	169.7	402.1	785.4

BASIC PERFORMANCE DATA

Performance data for single anchor without influence of edge distance and spacing - ETAG 001

Size	M6	M8	M10	M12	M16	M20
Effective embedment depth h _{ef} [mm]	25	30	40	50	65	80
MEAN ULTIMATE LOAD						
TENSION AND SHEAR LOAD F _{Ru,m} [kN]	-	-	-	-	-	-
CHARACTERISTIC LOAD						
TENSION AND SHEAR LOAD F _{Rk} [kN]	1.50	3.00	4.50	6.00	13.00	17.00
DESIGN LOAD						
TENSION AND SHEAR LOAD F _{Rd} [kN]	0.83	1.67	2.50	3.33	7.22	9.44
RECOMMENDED LOAD						
TENSION AND SHEAR LOAD F _{Rc} [kN]	0.60	1.19	1.79	2.38	5.16	6.75

DESIGN PERFORMANCE DATA

Size	M6	M8	M10	M12	M16	M20
Effective embedment depth h _{ef} [mm]	25	30	40	50	65	80
TENSION AND SHEAR LOAD						
Characteristic resistance F _{Rk} [kN]	1.52	3.01	4.57	6.43	13.31	17.38
Installation safety factor γ ₂	-	1.20	1.20	1.20	1.20	1.20
Spacing s _{cr} [mm]	200	200	200	200	260	320
Edge distance c _{cr} [mm]	150	150	150	150	195	240
SHEAR LOAD						
STEEL FAILURE; [ENGLISH]: STAL KLASY 4.8						
Characteristic resistance with lever arm M _{Rk,s} [Nm]	6.00	15.00	30.00	52.00	133.00	260.00
Partial safety factor γ _{Ms}	-	1.25	1.25	1.25	1.25	1.25
STEEL FAILURE; STEEL CLASS 5.8						
Characteristic resistance with lever arm M _{Rk,s} [Nm]	8.00	19.00	37.00	66.00	167.00	325.00
Partial safety factor γ _{Ms}	-	1.25	1.25	1.25	1.25	1.25
STEEL FAILURE; [ENGLISH]: STAL KLASY 6.8						
Characteristic resistance with lever arm M _{Rk,s} [Nm]	9.00	23.00	45.00	79.00	200.00	390.00
Partial safety factor γ _{Ms}	-	1.25	1.25	1.25	1.25	1.25
STEEL FAILURE; STEEL CLASS 8.8						
Characteristic resistance with lever arm M _{Rk,s} [Nm]	12.00	30.00	60.00	105.00	267.00	520.00
Partial safety factor γ _{Ms}	-	1.25	1.25	1.25	1.25	1.25

DESIGN PERFORMANCE DATA

Characteristic Resistance under fire exposure in concrete C20/25 to C50/60

Size	M8	M10	M12	M16	M20
TENSION AND SHEAR LOAD					
Effective embedment depth h _{ef} [mm]	30	40	50	65	80
R (for EI) = 30 min					
TENSION AND SHEAR LOAD					
Characteristic resistance F _{Rk} [kN]	0.40	0.90	1.60	3.10	4.30
R (for EI) = 60 min					
TENSION AND SHEAR LOAD					
Characteristic resistance F _{Rk} [kN]	0.30	0.80	1.30	2.40	3.70
R (for EI) = 90 min					
TENSION AND SHEAR LOAD					
Characteristic resistance F _{Rk} [kN]	0.30	0.60	1.10	2.00	3.20
R (for EI) = 120 min					
TENSION AND SHEAR LOAD					
Characteristic resistance F _{Rk} [kN]	0.20	0.50	0.80	1.60	2.50

R-DCL LIPPED WEDGE ANCHOR

High performance mechanical anchor



FEATURES AND BENEFITS

- High performance in cracked and non-cracked concrete confirmed by ETA
- Product is covered with European Technical Assessment for multi-point non-structural fixings
- Product recommended for applications requiring fire resistance
- Internally threaded to be used with threaded stud or bolt
- Easy to install by hammer action and manual setting tool
- Slotted sleeve and internal wedge component together facilitate easy setting and expansion

APPLICATIONS

- Pipelines systems
- Ventilation systems
- Sprinkler systems
- Cable conduits and wires
- Gratings

BASE MATERIALS

- Approved for use in:
- Cracked concrete C20/25-C50/60
 - Non-cracked concrete C20/25-C50/60
 - Unreinforced concrete
 - Reinforced concrete

INSTALLATION GUIDE



- Drill a hole of required diameter and depth
- Clear the hole of drilling dust and debris (using blowpump or equivalent method)
- Insert wedge anchor, slotted end first
- Use the setting tool to drive the internal wedge into the anchor
- Insert bolt or stud through fixture and tighten to the recommended torque

PRODUCT INFORMATION

Size	Product Code	Anchor				Fixture Hole diameter
		Diameter	External diameter	Length	Internal thread length	
		d	d _{nom}	L	l _g	
M6	R-DCL-06	6	8	25	11	7
M8	R-DCL-08-25	8	10	25	14	9
	R-DCL-08	8	10	30	14	9
M10	R-DCL-10-25	10	12	25	14	12
	R-DCL-10	10	12	40	19	12
M12	R-DCL-12-25	12	15	25	14	14
	R-DCL-12	12	15	50	25	14
M16	R-DCL-16	16	20	65	28	18

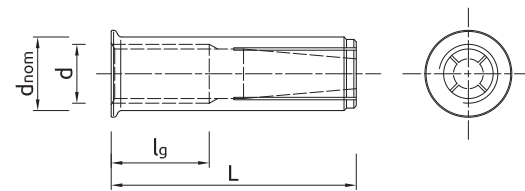

INSTALLATION DATA

Normal concrete

Size	M6	M8/25	M8	M10/25	M10	M12/25	M12	M16		
Thread diameter	d	[mm]	6	8	8	10	10	12	12	16
Hole diameter in substrate	d _o	[mm]	8	10	10	12	12	15	15	20
Max. installation torque	T _{inst}	[Nm]	4.5	11	11	22	22	38	38	98
Min. hole depth in substrate	h _o	[mm]	27	27	32	27	42	27	52	67
Min. installation depth	h _{nom}	[mm]	25	25	30	25	40	25	50	65
Min. substrate thickness	h _{min}	[mm]	80	80	80	80	80	80	100	130
Min. spacing	s _{min}	[mm]	200	200	200	200	200	200	200	260
Min. edge distance	c _{min}	[mm]	150	150	150	150	150	150	150	195

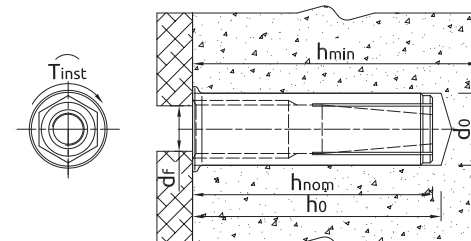

R-DCL LIPPED WEDGE ANCHOR

INSTALLATION DATA

Hollow concrete slab

Size	M6	M8/25	M8	M10/25	M10	M12/25	M12		
Thread diameter	d	[mm]	6	8	8	10	10	12	12
Hole diameter in substrate	d _o	[mm]	8	10	10	12	12	15	15
Max. installation torque	T _{inst}	[Nm]	4.5	11	11	22	22	38	38
Min. hole depth in substrate	h _o	[mm]	25	27	32	27	42	27	52
Min. installation depth	h _{nom}	[mm]	25	25	30	25	40	25	50
MINIMUM EMBEDMENT DEPTH									
Minimum distance between anchor groups	a _{min,min}	[mm]	100	100	100	100	100	100	100
Min. spacing	s _{min}	[mm]	100	100	100	100	100	100	100
Min. edge distance	c _{min}	[mm]	50	50	50	50	50	50	50

MECHANICAL PROPERTIES

Size	M6	M8	M10	M12	M16		
Nominal ultimate tensile strength - tension	F _{uk}	[N/mm ²]	450	450	450	450	450
Nominal yield strength - tension	F _{yk}	[N/mm ²]	360	360	360	360	360
Cross sectional area - tension	A _s	[mm ²]	20.1	36.6	58	84.3	157
Elastic section modulus	W _{el}	[mm ³]	21.21	50.3	98.2	169.7	402.1

BASIC PERFORMANCE DATA

Performance data for single anchor without influence of edge distance and spacing

Size	M6	M8/25	M8	M10/25	M10	M12/25	M12	M16	
CRACKED AND NON-CRACKED CONCRETE									
Effective embedment depth h _{ef}	[mm]	25	25	30	25	40	25	50	65
HOLLOW CORE SLAB									
Effective embedment depth h _{ef}	[mm]	25	25	30	25	40	25	50	-
MEAN ULTIMATE LOAD									
TENSION AND SHEAR LOAD F_{Rd,m}									
CRACKED AND NON-CRACKED CONCRETE	[kN]	-	-	-	-	-	-	-	-
HOLLOW CORE SLAB	[kN]	-	-	-	-	-	-	-	-
CHARACTERISTIC LOAD									
TENSION AND SHEAR LOAD F_{Rk}									
CRACKED AND NON-CRACKED CONCRETE	[kN]	1.50	1.00	3.00	1.50	4.50	2.00	6.00	13.00
HOLLOW CORE SLAB	[kN]	3.50	4.50	4.00	5.50	14.00	7.00	16.00	-
DESIGN LOAD									
TENSION AND SHEAR LOAD F_{Rd}									
CRACKED AND NON-CRACKED CONCRETE	[kN]	0.83	0.60	1.67	0.83	2.50	1.10	3.33	7.22
HOLLOW CORE SLAB	[kN]	1.66	2.14	1.90	2.61	6.66	3.33	8.88	-
RECOMMENDED LOAD									
TENSION AND SHEAR LOAD F_{rec}									
CRACKED AND NON-CRACKED CONCRETE	[kN]	0.60	0.40	1.19	0.60	1.79	0.80	2.38	5.16
HOLLOW CORE SLAB	[kN]	1.19	1.53	1.36	1.87	4.76	2.38	6.34	-

DESIGN PERFORMANCE DATA

Size	M6	M8	M10	M12	M16	M8/25	M10/25	M12/25		
Effective embedment depth	h _{ef}	[mm]	25	30	40	50	65	25	25	25
TENSION AND SHEAR LOAD										
Characteristic resistance	F _{Rk}	[kN]	1.52	3.01	4.57	6.43	13.31	1.00	1.50	2.00
Installation safety factor	γ ₂	-	1.20	1.20	1.20	1.20	1.20	1.20	1.20	1.20
Spacing	s _{cr}	[mm]	200	200	200	200	260	200	200	200
Edge distance	c _{cr}	[mm]	150	150	150	150	195	150	150	150
SHEAR LOAD										
STEEL FAILURE; [ENGLISH]: STAL KLASY 4.8										
Characteristic resistance with lever arm	M _{Rk,s}	[Nm]	6.00	15.00	30.00	52.00	133.00	15.00	30.00	52.00
Partial safety factor	γ _{Ms}	-	1.25	1.25	1.25	1.25	1.25	1.25	1.25	1.25
STEEL FAILURE; STEEL CLASS 5.8										
Characteristic resistance with lever arm	M _{Rk,s}	[Nm]	8.00	19.00	37.00	66.00	167.00	19.00	37.00	66.00
Partial safety factor	γ _{Ms}	-	1.25	1.25	1.25	1.25	1.25	1.25	1.25	1.25
STEEL FAILURE; [ENGLISH]: STAL KLASY 6.8										
Characteristic resistance with lever arm	M _{Rk,s}	[Nm]	9.00	23.00	45.00	79.00	200.00	23.00	45.00	66.00
Partial safety factor	γ _{Ms}	-	1.25	1.25	1.25	1.25	1.25	1.25	1.25	1.25
STEEL FAILURE; STEEL CLASS 8.8										
Characteristic resistance with lever arm	M _{Rk,s}	[Nm]	12.00	30.00	60.00	105.00	267.00	30.00	60.00	105.00
Partial safety factor	γ _{Ms}	-	1.25	1.25	1.25	1.25	1.25	1.25	1.25	1.25

R-DCL LIPPED WEDGE ANCHOR

DESIGN PERFORMANCE DATA (cont.)

Characteristic Resistance under fire exposure in concrete C20/25 to C50/60

Size	M8	M10	M12	M16	M8/25	M10/25	M12/25
TENSION AND SHEAR LOAD							
Effective embedment depth	h_{ef} [mm]	30	40	50	65	25	25
R (for EI) = 30 min							
TENSION AND SHEAR LOAD							
Characteristic resistance	F_{Rk} [kN]	0.40	0.90	1.60	3.10	0.10	0.20
R (for EI) = 60 min							
TENSION AND SHEAR LOAD							
Characteristic resistance	F_{Rk} [kN]	0.30	0.80	1.30	2.40	0.10	0.30
R (for EI) = 90 min							
TENSION AND SHEAR LOAD							
Characteristic resistance	F_{Rk} [kN]	0.30	0.60	1.10	2.00	0.10	0.30
R (for EI) = 120 min							
TENSION AND SHEAR LOAD							
Characteristic resistance	F_{Rk} [kN]	0.20	0.50	0.80	1.60	0.10	0.20

R-LX CONCRETE SCREW ANCHORS MULTI-POINT NON-STRUCTURAL FIXINGS

Self-tapping concrete screwbolt



Hexagonal head screw with washer
R-LX-HF



Countersunk head screw
R-LX-CS



Internally threaded head screw
R-LX-I



Externally threaded head screw
R-LX-E



Panhead screw
R-LX-P



Panhead XL screw
R-LX-PX-ZP



Hexagonal head screw for temporary installation
R-LX-H*

*not included in the approval



FEATURES AND BENEFITS

- Time-efficient installation through streamlined procedure - simply drill and drive
- Completely removable with possibility of reuse
- Unique design with patented threadform ensures high performance for relatively small hole diameter
- Non-expansion functioning ensures low risk of damage to base material and makes R-LX ideal for installation near edges and adjacent anchors
- Special zinc flake corrosion-resistant coating
- High performance in both uncracked and cracked concrete
- Different head types for any application
- Oversize head for fixtures with elongated holes
- Excellent product for temporary fixing
- Suitable for standard and reduced embedment depth

APPLICATIONS

- Through-fixing
- Temporary anchorages
- Formwork support systems
- Balustrading & handrails
- Fencing & gates manufacturing and installation
- Racking systems
- Public seating
- Scaffolding

BASE MATERIALS

- Approved for use in:
- Cracked concrete C20/25-C50/60
 - Non-cracked concrete C20/25-C50/60
 - Reinforced concrete
 - Unreinforced concrete
 - Hollow Core Slab (only R-LX-06)
- Also suitable for use in:
- Natural Stone (after site testing)

R-LX CONCRETE SCREW ANCHORS MULTI-POINT NON-STRUCTURAL FIXINGS

PRODUCT INFORMATION

R-LX-HF HEXAGONAL HEAD SCREW WITH WASHER

Product Code	Drill	Anchor		Fixture				
		Diameter	Length	Max. thickness t_{fix} for:		Hole diameter		
		d	L	$h_{nom,s}$	$h_{nom,r}$	d_f		
		[mm]	[mm]	[mm]	[mm]	[mm]	[mm]	[mm]
R-LX-HF-ZF	R-LX-HF-ZP							
5 R-LX-05X050-HF-ZF	R-LX-05X050-HF-ZP	5	6.3	50	7	-	7	
R-LX-05X075-HF-ZF	R-LX-05X075-HF-ZP	5	6.3	75	32	-	7	
R-LX-06X035-HF-ZF	R-LX-06X035-HF-ZP	6	7.5	35	-	-	9	
-	R-LX-06X040-HF-ZP	6	7.5	40	-	1	-	
R-LX-06X050-HF-ZF	R-LX-06X050-HF-ZP	6	7.5	50	-	7	9	
-	R-LX-06X060-HF-ZP	6	7.5	60	5	17	9	
R-LX-06X075-HF-ZF	R-LX-06X075-HF-ZP	6	7.5	75	20	32	9	
-	R-LX-06X090-HF-ZP	6	7.5	90	35	47	9	
R-LX-06X100-HF-ZF	R-LX-06X100-HF-ZP	6	7.5	100	45	57	9	
R-LX-06X130-HF-ZF	R-LX-06X130-HF-ZP	6	7.5	130	75	87	9	
R-LX-06X150-HF-ZF	R-LX-06X150-HF-ZP	6	7.5	150	95	107	9	
R-LX-08X060-HF-ZF	R-LX-08X060-HF-ZP	8	10	60	-	10	12	
R-LX-08X075-HF-ZF	R-LX-08X075-HF-ZP	8	10	75	5	30	12	
R-LX-08X090-HF-ZF	R-LX-08X090-HF-ZP	8	10	90	20	40	12	
R-LX-08X100-HF-ZF	R-LX-08X100-HF-ZP	8	10	100	30	50	12	
-	R-LX-08X120-HF-ZP	8	10	120	50	70	12	
R-LX-08X130-HF-ZF	R-LX-08X130-HF-ZP	8	10	130	60	80	12	
R-LX-08X150-HF-ZF	R-LX-08X150-HF-ZP	8	10	150	80	100	12	
-	R-LX-10X060-HF-ZP	10	12.5	60	-	5	14	
R-LX-10X065-HF-ZF	R-LX-10X065-HF-ZP	10	12.5	65	-	10	14	
R-LX-10X075-HF-ZF	R-LX-10X075-HF-ZP	10	12.5	75	-	20	14	
R-LX-10X085-HF-ZF	R-LX-10X085-HF-ZP	10	12.5	85	-	30	14	
-	R-LX-10X090-HF-ZP	10	12.5	90	5	35	14	
R-LX-10X100-HF-ZF	R-LX-10X100-HF-ZP	10	12.5	100	15	45	14	
-	R-LX-10X110-HF-ZP	10	12.5	110	25	55	14	
R-LX-10X120-HF-ZF	R-LX-10X120-HF-ZP	10	12.5	120	35	65	14	
-	R-LX-10X130-HF-ZP	10	12.5	130	45	75	14	
R-LX-10X140-HF-ZF	R-LX-10X140-HF-ZP	10	12.5	140	55	85	14	
-	R-LX-10X150-HF-ZP	10	12.5	150	65	95	14	
R-LX-12X075-HF-ZF	R-LX-12X075-HF-ZP	12	14	75	-	10	16	
R-LX-12X100-HF-ZF	R-LX-12X100-HF-ZP	12	14	100	-	35	16	
R-LX-12X130-HF-ZF	R-LX-12X130-HF-ZP	12	14	130	30	65	16	
R-LX-12X150-HF-ZF	R-LX-12X150-HF-ZP	12	14	150	50	85	16	
R-LX-14X080-HF-ZF	R-LX-14X080-HF-ZP	14	17	80	-	5	18	
R-LX-14X105-HF-ZF	R-LX-14X105-HF-ZP	14	17	105	-	30	18	
R-LX-14X115-HF-ZF	R-LX-14X115-HF-ZP	14	17	115	-	40	18	
R-LX-14X135-HF-ZF	R-LX-14X135-HF-ZP	14	17	135	15	60	18	
-	R-LX-14X160-HF-ZP	14	17	160	40	85	18	

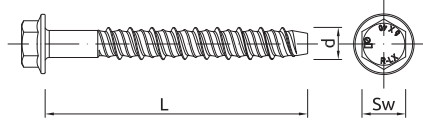

R-LX-CS COUNTERSUNK HEAD SCREW

Product Code	Drill	Anchor		Fixture			
		Diameter	Length	Max. thickness t_{fix} for:		Hole diameter	
		d	L	$h_{nom,s}$	$h_{nom,r}$	d_f	
		[mm]	[mm]	[mm]	[mm]	[mm]	[mm]
R-LX-CS-ZF	R-LX-CS-ZP						
5 R-LX-05X050-CS-ZF	R-LX-05X050-CS-ZP	5	6.3	50	7	-	7
R-LX-05X075-CS-ZF	R-LX-05X075-CS-ZP	5	6.3	75	32	-	7
R-LX-06X050-CS-ZF	R-LX-06X050-CS-ZP	6	7.5	50	-	7	9
-	R-LX-06X060-CS-ZP	6	7.5	60	5	17	9
R-LX-06X075-CS-ZF	R-LX-06X075-CS-ZP	6	7.5	75	20	32	9
-	R-LX-06X090-CS-ZP	6	7.5	90	35	47	9
R-LX-06X100-CS-ZF	R-LX-06X100-CS-ZP	6	7.5	100	45	57	9
R-LX-06X130-CS-ZF	R-LX-06X130-CS-ZP	6	7.5	130	75	87	9
R-LX-06X150-CS-ZF	R-LX-06X150-CS-ZP	6	7.5	150	95	107	9

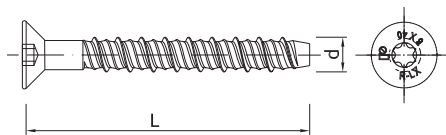

R-LX CONCRETE SCREW ANCHORS - STRUCTURAL FIXINGS

PRODUCT INFORMATION (cont.)

R-LX-CS COUNTERSUNK HEAD SCREW (cont.)

Product Code	Drill	Anchor		Fixture			
		Diameter	Length	Max. thickness t_{fix} for:		Hole diameter	
		d	L	$h_{nom,s}$	$h_{nom,r}$	d_f	
		[mm]	[mm]	[mm]	[mm]	[mm]	[mm]
R-LX-08X060-CS-ZF	R-LX-08X060-CS-ZP	8	10	60	-	10	12
R-LX-08X075-CS-ZF	R-LX-08X075-CS-ZP	8	10	75	5	30	12
R-LX-08X090-CS-ZF	R-LX-08X090-CS-ZP	8	10	90	20	40	12
R-LX-08X100-CS-ZF	R-LX-08X100-CS-ZP	8	10	100	30	50	12
-	R-LX-08X120-CS-ZP	8	10	120	50	70	12
R-LX-08X130-CS-ZF	R-LX-08X130-CS-ZP	8	10	130	60	80	12
R-LX-08X150-CS-ZF	R-LX-08X150-CS-ZP	8	10	150	80	100	12
-	R-LX-10X060-CS-ZP	10	12.5	60	-	5	14
R-LX-10X065-CS-ZF	R-LX-10X065-CS-ZP	10	12.5	65	-	10	14
R-LX-10X075-CS-ZF	R-LX-10X075-CS-ZP	10	12.5	75	-	20	14
R-LX-10X085-CS-ZF	R-LX-10X085-CS-ZP	10	12.5	85	-	30	14
-	R-LX-10X090-CS-ZP	10	12.5	90	5	35	14
R-LX-10X100-CS-ZF	R-LX-10X100-CS-ZP	10	12.5	100	15	45	14
-	R-LX-10X110-CS-ZP	10	12.5	110	25	55	14
R-LX-10X120-CS-ZF	R-LX-10X120-CS-ZP	10	12.5	120	35	65	14
-	R-LX-10X130-CS-ZP	10	12.5	130	45	75	14
R-LX-10X140-CS-ZF	R-LX-10X140-CS-ZP	10	12.5	140	55	85	14
-	R-LX-10X150-CS-ZP	10	12.5	150	65	95	14
R-LX-10X160-CS-ZF	R-LX-10X160-CS-ZP	10	12.5	160	75	105	14

R-LX-I, R-LX-I 8/10 INTERNALLY THREADED HEAD SCREW

Product Code	Drill	Anchor		Internal thread	Max. thickness t_{fix} for:		Hole diameter
		Diameter	Length		$h_{nom,s}$	$h_{nom,r}$	
		d	L		[mm]	[mm]	
		[mm]	[mm]		[mm]	[mm]	[mm]
R-LX-I-ZP							
5 -	R-LX-05X025-I06-ZP	5	6	35	M8	-	-
-	R-LX-06X035-I06-ZP	6	7.5	35	M8	-	-
-	R-LX-06X035-I08-ZP	6	7.5	35	M8	-	-
-	R-LX-06X055-I08-ZP	6	7.5	55	M8	-	-
6 -	R-LX-06X035-I10-ZP	6	7.5	35	M10	-	-
-	R-LX-06X055-I10-ZP	6	7.5	55	M10	-	-
-	R-LX-06X035-I8/10Z	6	7.5	35	M8/M10	-	-
-	R-LX-06X055-I8/10Z	6	7.5	55	M8/M10	-	-
8 -	R-LX-08X050-I12-ZP	8	10	50	M12	-	-
10 -	R-LX-10X055-I16-ZP	10	12.5	55	M16	-	-

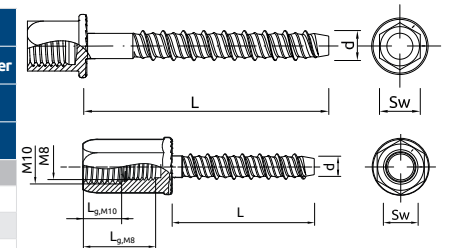

R-LX-E EXTERNALLY THREADED HEAD SCREW

Product Code	Drill	Anchor		Fixture		
		Diameter	Length	Max. thickness t_{fix} for:		Hole diameter
		d	L	$h_{nom,std}$	$h_{nom,red}$	d_f
		[mm]	[mm]	[mm]	[mm]	[mm]
R-LX-E-ZP						
6 -	R-LX-06X035-E8-ZP	6	7.5	35	-	-
-	R-LX-06X055-E-ZP	6	7.5	55	-	-

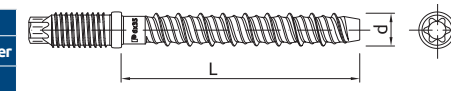

R-LX-P-ZP PANHEAD SCREW

Product Code	Drill	Anchor		Fixture			
		Diameter	Length	Max. thickness t_{fix} for:		Hole diameter	
		d	L	$h_{nom,std}$	$h_{nom,red}$	d_f	
		[mm]	[mm]	[mm]	[mm]	[mm]	
R-LX-PX-ZP							
6 -	R-LX-06X035-PX-ZP	6	7.5	35	55	39	9
-	R-LX-06X040-PX-ZP	6	7.5	40	-	1	9

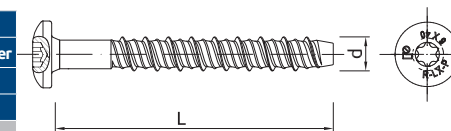

R-LX CONCRETE SCREW ANCHORS MULTI-POINT NON-STRUCTURAL FIXINGS

PRODUCT INFORMATION (cont.)

R-LX-H HEXAGONAL HEAD SCREW FOR TEMPORARY INSTALLATION

Product Code	Drill	Anchor		Fixture			
		Diameter	Length	Max. thickness t_{fix} for:		Hole diameter	
		d [mm]	L [mm]	$h_{nom, std}$ [mm]	$h_{nom, red}$ [mm]	d_f [mm]	
R-LX-H-ZF	R-LX-H-ZP						
*R-LX-08X060-H-ZF	*R-LX-08X060-H-ZP	8	10	60	-	10	12
*R-LX-08X075-H-ZF	*R-LX-08X075-H-ZP	8	10	75	5	25	12
*R-LX-08X090-H-ZF	*R-LX-08X090-H-ZP	8	10	90	20	40	12
*R-LX-08X100-H-ZF	*R-LX-08X100-H-ZP	8	10	100	30	50	12
*R-LX-08X130-H-ZF	*R-LX-08X130-H-ZP	8	10	130	60	80	12
*R-LX-08X150-H-ZF	*R-LX-08X150-H-ZP	8	10	150	80	100	12
*R-LX-10X065-H-ZF	*R-LX-10X065-H-ZP	10	12.5	65	-	10	14
*R-LX-10X075-H-ZF	*R-LX-10X075-H-ZP	10	12.5	75	-	20	14
*R-LX-10X085-H-ZF	*R-LX-10X085-H-ZP	10	12.5	85	-	30	14
*R-LX-10X100-H-ZF	*R-LX-10X100-H-ZP	10	12.5	100	15	45	14
*R-LX-10X120-H-ZF	*R-LX-10X120-H-ZP	10	12.5	120	35	65	14
*R-LX-10X140-H-ZF	*R-LX-10X140-H-ZP	10	12.5	140	55	85	14

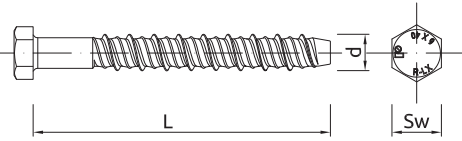

*not included in the approval

INSTALLATION DATA

R-LX-HF

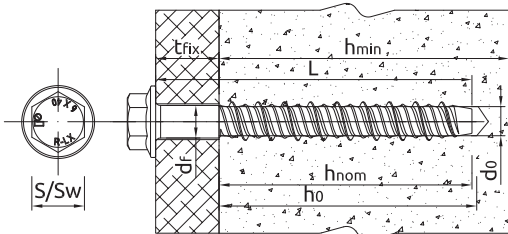

R-LX-CS

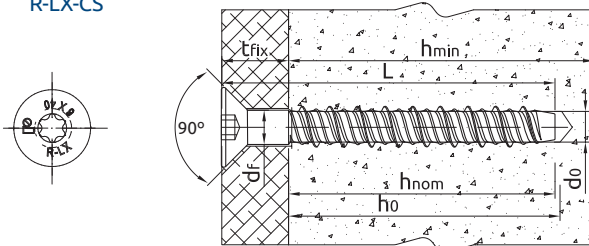

R-LX-I

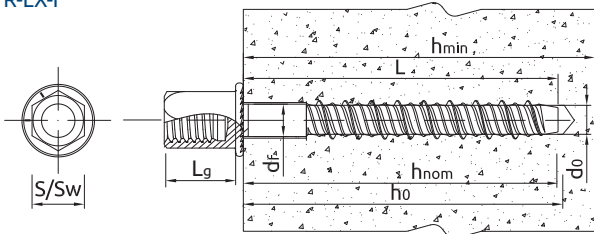

R-LX-E

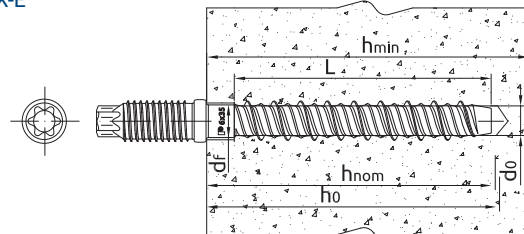

R-LX-P

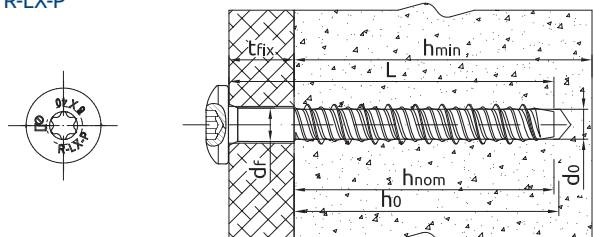

R-LX-PX

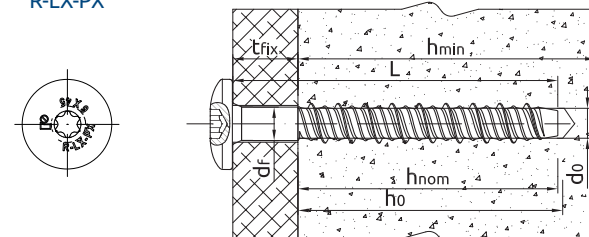

R-LX-H

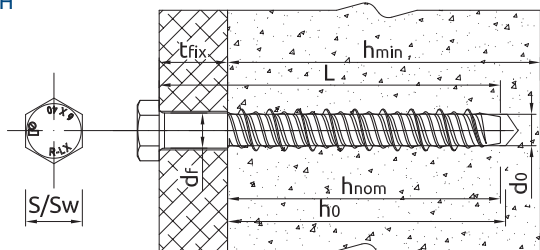

R-LX CONCRETE SCREW ANCHORS MULTI-POINT NON-STRUCTURAL FIXINGS

INSTALLATION DATA

Normal concrete

Size			5	6	8	10
Thread diameter	d	[mm]	6,3	7,5	10	12,5
Hole diameter in substrate	d_o	[mm]	5	6	8	10
Wrench size for hex head	Sw	[mm]	8	10	13	15
Wrench size for internally threaded head	Sw_i	[mm]	10	13	15	21
Torx driver for externally threaded head			-	E7	-	-
Torx driver for countersunk and pan head			T25	T30	T45	T50
Max. installation torque for impact driver	$T_{imp, max}$	[Nm]	200	400	900	950
STANDARD EMBEDMENT DEPTH						
Min. hole depth in substrate	$h_{0, s}$	[mm]	50	65	80	95
Real hole depth in substrate	h_o	[mm]	$L + 10 - t_{fix}$	$L + 10 - t_{fix}$	$L + 10 - t_{fix}$	$L + 10 - t_{fix}$
Min. installation depth	$h_{nom, s}$	[mm]	40	55	70	85
Min. substrate thickness	$h_{min, s}$	[mm]	80	84	110	130
Min. spacing	$s_{min, s}$	[mm]	40	45	50	60
Min. edge distance	$c_{min, s}$	[mm]	40	45	50	60
REDUCED EMBEDMENT DEPTH						
Min. hole depth in substrate	$h_{0, r}$	[mm]	35	50	60	65
Real hole depth in substrate	h_o	[mm]	$L + 10 - t_{fix}$	$L + 10 - t_{fix}$	$L + 10 - t_{fix}$	$L + 10 - t_{fix}$
Min. installation depth	$h_{nom, r}$	[mm]	25	39	50	55
Min. substrate thickness	$h_{min, r}$	[mm]	80	80	80	80
Min. spacing	$s_{min, r}$	[mm]	40	45	50	60
Min. edge distance	$c_{min, r}$	[mm]	40	45	50	60
MINIMUM EMBEDMENT DEPTH						
Min. hole depth in substrate	$h_{0, m}$	[mm]	-	45	-	-
Real hole depth in substrate	h_o	[mm]	-	$L + 10 - t_{fix}$	-	-
Min. installation depth	$h_{nom, m}$	[mm]	-	35	-	-
Min. substrate thickness	$h_{min, m}$	[mm]	-	80	-	-
Min. spacing	$s_{min, m}$	[mm]	-	45	-	-
Min. edge distance	$c_{min, m}$	[mm]	-	45	-	-

INSTALLATION DATA HOLLOW CONCRETE SLAB

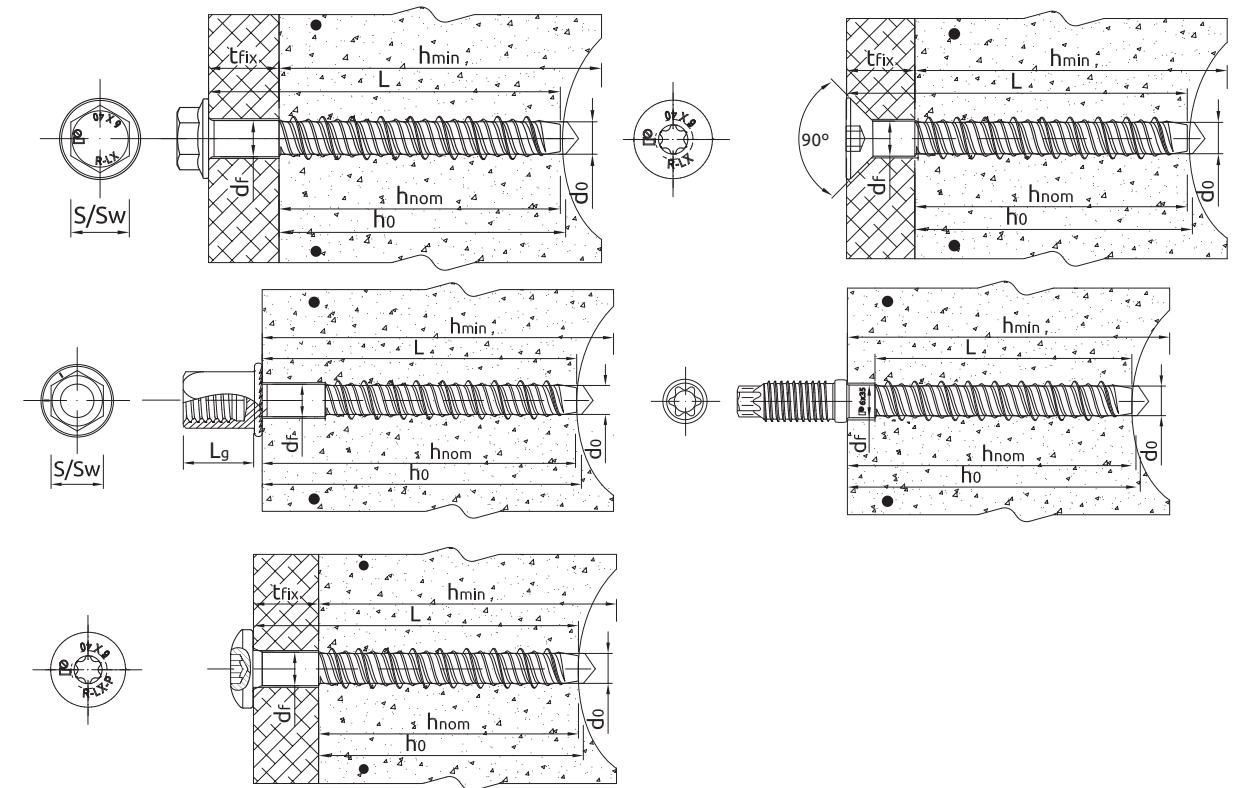

R-LX CONCRETE SCREW ANCHORS MULTI-POINT NON-STRUCTURAL FIXINGS

Hollow concrete slab

Size	6		
Thread diameter	d	[mm]	7.5
Hole diameter in substrate	d _h	[mm]	6
Wrench size for hex head	Sw	[mm]	10
Wrench size for internally threaded head	Sw _i	[mm]	13
Torx driver for externally threaded head			E7
Torx driver for countersunk and pan head			T30
Max. installation torque for impact driver	T _{imp,max}	[Nm]	400
MINIMUM EMBEDMENT DEPTH			
Min. hole depth in substrate	h _{0,m}	[mm]	45
Real hole depth in substrate	h ₀	[mm]	L + 10 - t _{fix}
Min. installation depth	h _{nom,m}	[mm]	35
Min. spacing	s _{min,m}	[mm]	100
Min. edge distance	c _{min,m}	[mm]	50

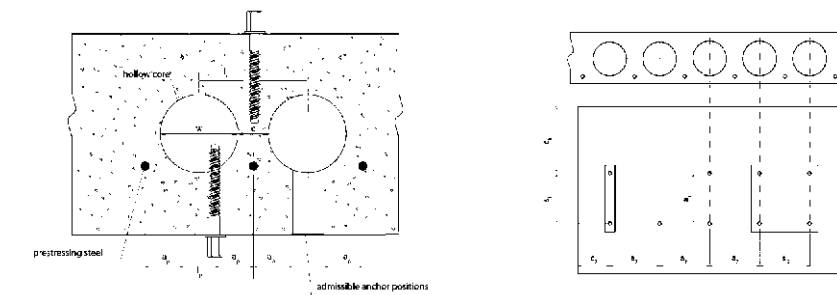

c1, c2, - edge distance
s1, s2, - anchor spacing
a1, a2, - distance between anchor groups

Core width / Web thickness; w / e	≤ 4.2
Core distance	l _c ≥ 100 mm
Prestressing steel	l _p ≥ 100 mm
Distance between anchor position an prestressing steel	a _p ≥ 50 mm

MECHANICAL PROPERTIES

Size	5				6				8				10			
Nominal ultimate tensile strength - tension	F _{uk}	[N/mm ²]	1300	1250	1200	1150	1100	1050	1000	950	900	850	800	750	700	
Nominal yield strength - tension	F _{yk}	[N/mm ²]	1150	1100	1050	1000	950	900	850	800	750	700	650	600	550	
Cross sectional area - tension	A _s	[mm ²]	19.6	28.3	50.3	78.5										
Elastic section modulus	W _{el}	[mm ³]	12.2	21.2	50.3	98.1										
Characteristic bending resistance	M _{Rk,s}	[Nm]	19.0	31.8	72.4	123.6										
Design bending resistance	M	[Nm]	12.7	12.2	48.3	82.4										

BASIC PERFORMANCE DATA

Performance data for single anchor without influence of edge distance and spacing

Size	5				6				8				10			
CRACKED AND NON-CRACKED CONCRETE																
Reduced embedment depth h _{nom}	[mm]	25	-	50	55											
Minimum embedment depth h _{nom}	[mm]	-	35	-	-											
HOLLOW CORE SLAB																
Minimum embedment depth h _{nom}	[mm]	-	35	-	-											
CHARACTERISTIC LOAD																
TENSION AND SHEAR LOAD F_{Rk}																
CRACKED AND NON-CRACKED CONCRETE																
Reduced embedment depth	[kN]	3.00	-	7.50	9.00											
Minimum embedment depth	[kN]	-	3.00	-	-											
HOLLOW CORE SLAB																
Minimum embedment depth	[kN]	-	6.00	-	-											

R-LX CONCRETE SCREW ANCHORS MULTI-POINT NON-STRUCTURAL FIXINGS

BASIC PERFORMANCE DATA

Size	5				6				8				10			
DESIGN LOAD																
TENSION AND SHEAR LOAD F_{Rd}																
CRACKED AND NON-CRACKED CONCRETE																
Reduced embedment depth	[kN]	1.67	-	5.00	6.00											
Minimum embedment depth	[kN]	-	2.00	-	-											
HOLLOW CORE SLAB																
Minimum embedment depth	[kN]	-	4.00	-	-											
RECOMMENDED LOAD																
TENSION AND SHEAR LOAD F_{rec}																
CRACKED AND NON-CRACKED CONCRETE																
Reduced embedment depth	[kN]	1.19	-	3.57	4.28											
Minimum embedment depth	[kN]	-	1.42	-	-											
HOLLOW CORE SLAB																
Minimum embedment depth	[kN]	-	2.85	-	-											

Hollow concrete slabs C40/50 to C50/60

DESIGN PERFORMANCE DATA

Normal concrete

Size	5				6				8				10			
Min. installation depth	h _{nom}	[mm]	25	35	50	55										
Effective embedment depth	h _{ef}	[mm]	17	24	37	40										
TENSION AND SHEAR LOAD																
Characteristic resistance	F _{Rk}	[kN]	3.00	3.00	7.50	9.00										
Installation safety factor	γ _{inst}	-	1.20	1.00	1.00	1.00										
Increasing factors for N _{Rd,p} - C30/37	ψ _c	-	1.08	1.00	1.08	1.08										
Increasing factors for N _{Rd,p} - C40/50	ψ _c	-	1.15	1.00	1.15	1.15										
Increasing factors for N _{Rd,p} - C50/60	ψ _c	-	1.19	1.00	1.19	1.19										
Spacing	s _{cr,N}	-	70	100	120	120										
Edge distance	c _{cr,N}	-	35	50	60	60										
SHEAR LOAD																
STEEL FAILURE																
Characteristic resistance with lever arm	M _{Rk,s}	[Nm]	19.00	31.80	72.40	123.60										
Partial safety factor	γ _{Ms}	-	1.50	1.50	1.50	1.50										

DESIGN PERFORMANCE DATA

Characteristic Resistance under fire exposure in concrete C20/25 to C50/60

Size	8				10			
TENSION AND SHEAR LOAD								
Effective embedment depth	h _{ef}	[mm]	37	40				
R (for EI) = 30 min								
TENSION AND SHEAR LOAD								
Characteristic resistance	F _{Rk}	[kN]	0.75	1.57				
R (for EI) = 60 min								
TENSION AND SHEAR LOAD								
Characteristic resistance	F _{Rk}	[kN]	0.65	1.18				
R (for EI) = 90 min								
TENSION AND SHEAR LOAD								
Characteristic resistance	F _{Rk}	[kN]	0.50	1.02				
R (for EI) = 120 min								
TENSION AND SHEAR LOAD								
Characteristic resistance	F _{Rk}	[kN]	0.40	0.79				

R-LX CONCRETE SCREW ANCHORS MULTI-POINT NON-STRUCTURAL FIXINGS

DESIGN PERFORMANCE DATA

Hollow concrete slab

Size				6
Min. installation depth	h_{com}	[mm]		35
Effective embedment depth	h_{ef}	[mm]		24
Min. bottom flange thickness	d_b	[mm]		35
TENSION AND SHEAR LOAD				
HOLLOW CONCRETE SLAB C30/37				
Characteristic resistance	F_{Rk}	[kN]		5.00
HOLLOW CONCRETE SLAB C40/50				
Characteristic resistance	F_{Rk}	[kN]		6.00
HOLLOW CONCRETE SLAB C50/60				
Characteristic resistance	F_{Rk}	[kN]		6.00
Installation safety factor	V_{inst}	-		1.00
Spacing	$s_{c2,N}$	[mm]		100.00
Edge distance	$c_{c2,N}$	[mm]		50.00
SHEAR LOAD				
STEEL FAILURE				
Characteristic resistance with lever arm	$M_{Rk,s}$	[Nm]		31.80
Partial safety factor	V_{Ms}	-		1.50

R-S1-LX-TEST TESTING GAUGE

Concrete screw re-usability testing gauge

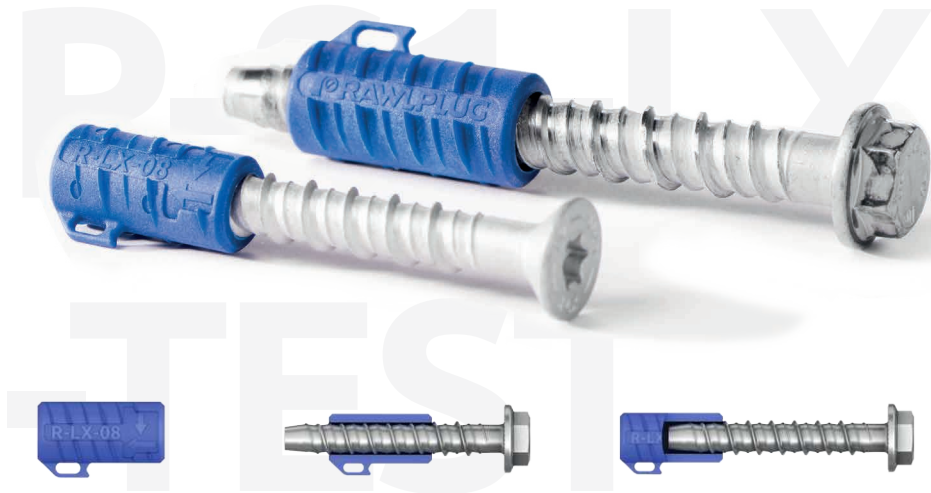

FEATURES AND BENEFITS

- Testing Gauge allows to determine whether the product R-LX is suitable for re-use.

APPLICATIONS

- Concrete screw re-usability testing gauge

INSTALLATION GUIDE

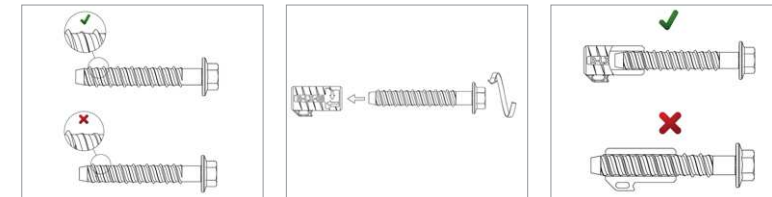

- Visual assessment. The anchor thread shall not be damaged.
- Drive the screw counterclockwise into the no-go gauge with at least one revolution during the test. You can re-use the anchor if its tip is not visible on the other end of the no-go gauge.
- Screws which failed the test 1 or the test 2 are not recommended to use

PRODUCT INFORMATION

Product Code	Description
R-S1-LX-TEST-08/2	Wear Gauge for R-LX-08
R-S1-LX-TEST-10/2	Wear Gauge for R-LX-10
R-S1-LX-TEST-14/2	Wear Gauge for R-LX-14

R-RB Rawlbolt®

FOR USE IN HOLLOW CORE SLAB AND CERAMIC SUBSTRATES

World's most popular all-purpose expanding shield anchor - bolt projecting version



Loose bolt
R-RBL Rawlbolt®

Bolt projecting
R-RBP Rawlbolt®

Bolt projecting with plastic ferrule
R-RBP-PF Rawlbolt®

Loose bolt with plastic ferrule
R-RBL-PF Rawlbolt®

Eye bolt
R-RBE Rawlbolt®

Shield
R-RB Rawlbolt®



FEATURES AND BENEFITS

- The only original Rawlbolt with single-piece cold-formed eyebolt for maximum durability
- Three-pieces expanding sleeve of maximum expansion provides optimal load and safety of use in any substrate
- Eye Rawlbolts are not suitable for all arrest systems nor shock loading
- Closed, forged hook for maximum safety

APPLICATIONS

- Supporting guy ropes, stays and cables
- Supporting ladder restraints

BASE MATERIALS

- Approved for use in:
- Cracked concrete C20/25-C50/60
 - Non-cracked concrete C20/25-C50/60
 - Unreinforced concrete
 - Reinforced concrete
 - Solid clay brick $\geq 20\text{MPa}$
 - Hollow Lightweight Concrete Block LAC $5 \geq 5\text{MPa}$
 - Hollow Sand-lime Brick $\geq 15\text{MPa}$
 - Concrete hollow floor block (eg. Teriva)
 - Hollow-core Slab C20/25
 - Hollow-core Slab C30/37-C50/60

R-RB Rawlbolt®

FOR USE IN HOLLOW CORE SLAB AND CERAMIC SUBSTRATES

INSTALLATION GUIDE

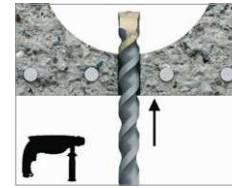

1. Drill a hole of required diameter and depth.



2. Remove pre-assembled bolt and washer. Insert shield into hole and tap home with hammer until flush with surface
3. Insert bolt with washer through fixture into the shield
4. Tighten to the recommended torque .



1. Drill a hole of required diameter and depth. Note: When fixing into brickwork, mortar joints should be avoided
2. Clear the hole of drilling dust and debris (using blowpump or equivalent method)

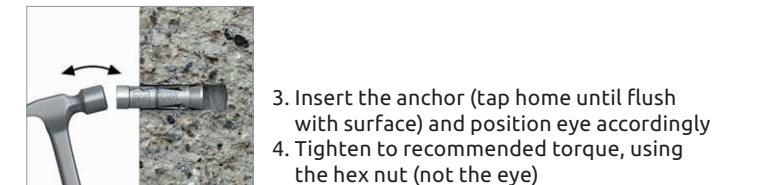

3. Insert the anchor (tap home until flush with surface) and position eye accordingly
4. Tighten to recommended torque, using the hex nut (not the eye)

R-RB Rawlbolt® FOR USE IN HOLLOW CORE SLAB AND CERAMIC SUBSTRATES

PRODUCT INFORMATION

R-RBL Rawlbolt® LOOSE BOLT

Size	Product Code	Anchor			Fixture	
		Diameter	External diameter	Length	Max. thickness	Hole diameter
		d	d _{nom}	L	t _{fix}	d _f
		[mm]	[mm]	[mm]	[mm]	[mm]
M6	R-RBL-M06/10W	6	12	55	10	6.5
	R-RBL-M06/25W	6	12	70	25	6.5
	R-RBL-M06/40W	6	12	85	40	6.5
M8	R-RBL-M08/10W	8	14	65	10	9
	R-RBL-M08/25W	8	14	80	25	9
	R-RBL-M08/40W	8	14	95	40	9
M10	R-RBL-M10/10W	10	16	75	10	11
	R-RBL-M10/25W	10	16	90	25	11
	R-RBL-M10/50W	10	16	115	50	11
M12	R-RBL-M12/10W	12	20	90	10	13
	R-RBL-M12/25W	12	20	105	25	13
	R-RBL-M12/40W	12	20	120	40	13
M16	R-RBL-M16/15W	16	25	135	15	17
	R-RBL-M16/30W	16	25	150	30	17
	R-RBL-M16/60W	16	25	180	60	17
M20	R-RBL-M20/60W	20	32	195	60	22
	R-RBL-M20/100W	20	32	235	110	22

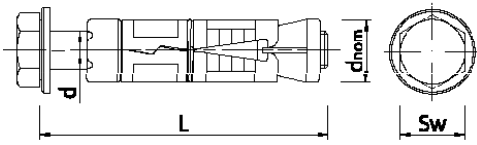

R-RBP Rawlbolt® BOLT PROJECTING

Size	Product Code	Anchor			Fixture	
		Diameter	External diameter	Length	Max. thickness	Hole diameter
		d	d _{nom}	L	t _{fix}	d _f
		[mm]	[mm]	[mm]	[mm]	[mm]
M6	R-RBP-M06/10W	6	12	65	10	6.5
	R-RBP-M06/25W	6	12	80	25	6.5
	R-RBP-M06/60W	6	12	115	60	6.5
M8	R-RBP-M08/10W	8	14	75	10	9
	R-RBP-M08/25W	8	14	90	25	9
	R-RBP-M08/60W	8	14	125	60	9
M10	R-RBP-M10/15W	10	16	90	15	11
	R-RBP-M10/30W	10	16	105	30	11
	R-RBP-M10/60W	10	16	135	60	11
M12	R-RBP-M12/15W	12	20	110	15	13
	R-RBP-M12/30W	12	20	125	30	13
	R-RBP-M12/75W	12	20	170	75	13
M16	R-RBP-M16/15W	16	25	150	15	17
	R-RBP-M16/35W	16	25	170	35	17
	R-RBP-M16/75W	16	25	210	75	17
M20	R-RBP-M20/15W	20	32	170	15	22
	R-RBP-M20/30W	20	32	185	30	22
	R-RBP-M20/100W	20	32	255	100	22

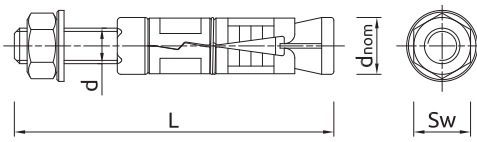

R-RBP-PF Rawlbolt® BOLT PROJECTING WITH PLASTIC FERRULE

Size	Product Code	Anchor			Fixture	
		Diameter	External diameter	Length	Max. thickness	Hole diameter
		d	d _{nom}	L	t _{fix}	d _f
		[mm]	[mm]	[mm]	[mm]	[mm]
M6	R-RBP-PF-M06/10W	6	12	65	10	6.5
	R-RBP-PF-M06/25W	6	12	80	25	6.5
	R-RBP-PF-M06/60W	6	12	115	60	6.5
M8	R-RBP-PF-M08/10W	8	14	75	10	9
	R-RBP-PF-M08/25W	8	14	90	25	9
	R-RBP-PF-M08/60W	8	14	125	60	9
M10	R-RBP-PF-M10/15W	10	16	90	15	11
	R-RBP-PF-M10/30W	10	16	105	30	11
	R-RBP-PF-M10/60W	10	16	135	60	11

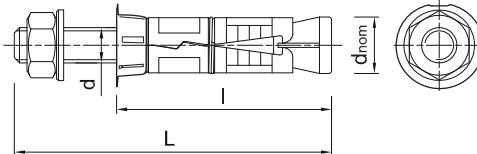

R-RB Rawlbolt® FOR USE IN CRACKED AND NON-CRACKED CONCRETE

PRODUCT INFORMATION

R-RBP-PF Rawlbolt® BOLT PROJECTING WITH PLASTIC FERRULE

Size	Product Code	Anchor			Fixture	
		Diameter	External diameter	Length	Max. thickness	Hole diameter
		d	d _{nom}	L	t _{fix}	d _f
		[mm]	[mm]	[mm]	[mm]	[mm]
M12	R-RBP-PF-M12/15W	12	20	110	15	13
	R-RBP-PF-M12/30W	12	20	125	30	13
	R-RBP-PF-M12/75W	12	20	170	75	13
M16	R-RBP-PF-M16/15W	16	25	150	15	17
	R-RBP-PF-M16/35W	16	25	170	35	17
	R-RBP-PF-M16/75W	16	25	210	75	17

R-RBL-PF Rawlbolt® LOOSE BOLT WITH PLASTIC FERRULE

Size	Product Code	Anchor			Fixture	
		Diameter	External diameter	Length	Max. thickness	Hole diameter
		d	d _{nom}	L	t _{fix}	d _f
		[mm]	[mm]	[mm]	[mm]	[mm]
M6	R-RBL-PF-M06/10W	6	12	55	10	6.5
	R-RBL-PF-M06/25W	6	12	70	25	6.5
	R-RBL-PF-M06/40W	6	12	85	40	6.5
M8	R-RBL-PF-M08/10W	8	14	65	10	9
	R-RBL-PF-M08/25W	8	14	80	25	9
	R-RBL-PF-M08/40W	8	14	95	40	9
M10	R-RBL-PF-M10/10W	10	16	75	10	11
	R-RBL-PF-M10/25W	10	16	90	25	11
	R-RBL-PF-M10/50W	10	16	115	50	11
M12	R-RBL-PF-M12/10W	12	20	90	10	13
	R-RBL-PF-M12/25W	12	20	105	25	13
	R-RBL-PF-M12/40W	12	20	120	40	13
M16	R-RBL-PF-M16/15W	16	25	135	15	17
	R-RBL-PF-M16/30W	16	25	150	30	17
	R-RBL-PF-M16/60W	16	25	180	60	17

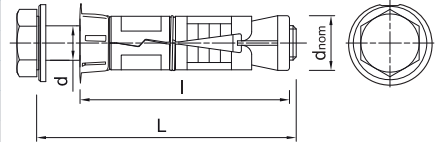

R-RBL-E Rawlbolt® EYE BOLT

Size	Product Code	Anchor			Fixture	
		Diameter	External diameter	Length	Max. thickness	Hole diameter
		d	d _{nom}	L	t _{fix}	d _f
		[mm]	[mm]	[mm]	[mm]	[mm]
M6	R-RBL-06EW	6	12	73	-	-
M8	R-RBL-08EW	8	14	87	-	-
M10	R-RBL-10EW	10	16	108	-	-
M12	R-RBL-12EW	12	20	130	-	-
M6	R-RB-M06W	6	12	45	6.5	-

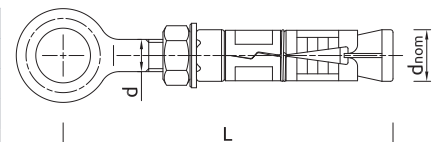

R-RB Rawlbolt® SHIELD

Size	Product Code	Anchor			Fixture	
		Diameter	External diameter	Length	Max. thickness	Hole diameter
		d	d _{nom}	L	t _{fix}	d _f
		[mm]	[mm]	[mm]	[mm]	[mm]
M8	R-RB-M08W	8	14	50	9	-
M10	R-RB-M10W	10	16	60	11	-
M12	R-RB-M12W	12	20	75	13	-
M16	R-RB-M16W	16	25	115	17	-
M20	R-RB-M20W	20	32	130	22	-
M24	R-RB-M24W	24	38	150	26	-

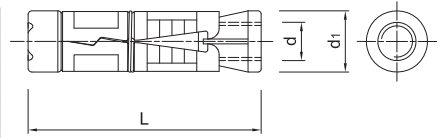

R-RB Rawlbolt® FOR USE IN HOLLOW CORE SLAB AND CERAMIC SUBSTRATES

INSTALLATION DATA

Installation in solid substrates

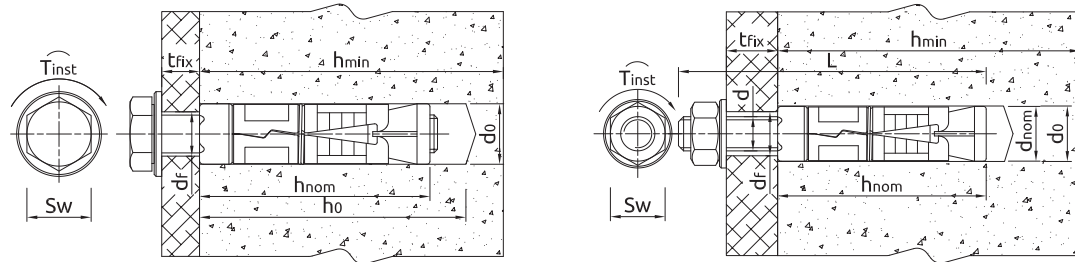

Installation in solid substrates

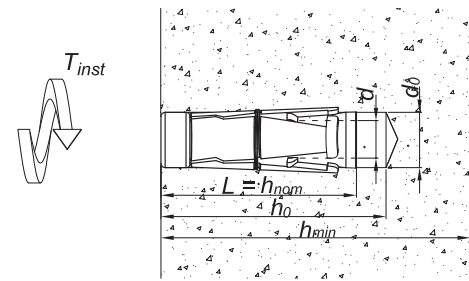

Installation in hollow core slab

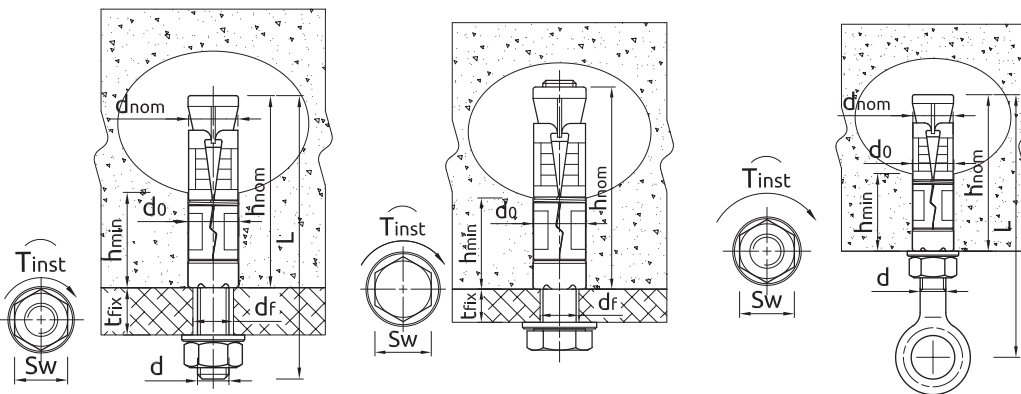

Size	M6	M8	M10	M12	M16	M20		
Thread diameter	d	[mm]	6	8	10	12	16	20
Hole diameter in substrate	d _o	[mm]	12	14	16	20	25	32
Min. installation depth	h _{nom}	[mm]	45	50	60	80	120	135
Min. hole depth in substrate	h _o	[mm]	50	55	65	85	125	140
Wrench size	Sw	[mm]	10	13	17	19	24	30
SOLID SUBSTRATES								
Installation torque	T _{inst}	[Nm]	6.5	15	27	50	120	230
Min. substrate thickness	h _{min}	[mm]	100	100	100	100	142	172
Min. spacing	s _{min}	[mm]	35	40	50	60	95	115
Min. edge distance	c _{min}	[mm]	53	60	75	90	143	173
CERAMIC AND HOLLOW SUBSTRATES								
Installation torque	T _{inst}	[Nm]	3	5	8	10	15	20
Min. spacing	s _{min}	[mm]	100	100	100	100	100	115
Min. edge distance	c _{min}	[mm]	100	100	100	100	143	173

R-RB Rawlbolt® FOR USE IN HOLLOW CORE SLAB AND CERAMIC SUBSTRATES

MECHANICAL PROPERTIES

Size	M6	M8	M10	M12	M16	M20		
Nominal ultimate tensile strength - tension	F _{uk}	[N/mm ²]	500	500	500	500	500	
Nominal yield strength - tension	F _{yk}	[N/mm ²]	400	400	400	400	400	
Cross sectional area - tension	A _s	[mm ²]	20.1	36.6	58	84.3	157	245
Elastic section modulus	W _{el}	[mm ³]	21.21	50.27	98.17	169.65	402.12	785.4
Characteristic bending resistance	M ⁰ _{Rk,s}	[Nm]	12.72	30.16	58.9	101.79	241.27	471.24
Design bending resistance	M	[Nm]	10.18	24.13	47.12	81.43	193.02	376.99

Mechanical properties for R-RBL-E

Size	M6	M8	M10	M12		
Nominal ultimate tensile strength - tension	F _{uk}	[N/mm ²]	300	300	300	
Nominal yield strength - tension	F _{yk}	[N/mm ²]	180	180	180	
Cross sectional area - tension	A _s	[mm ²]	20.1	36.6	58	84.3
Elastic section modulus	W _{el}	[mm ³]	21.21	50.27	98.17	169.65
Characteristic bending resistance	M ⁰ _{Rk,s}	[Nm]	12.72	30.16	58.9	101.79
Design bending resistance	M	[Nm]	10.18	24.13	47.12	81.43

BASIC PERFORMANCE DATA

Performance data for single anchor without influence of edge distance and spacing

Size	M6	M8	M10	M12	M16	M20		
CHARACTERISTIC LOAD								
TENSION LOAD N_{Rk}								
Hollow core slab min. C20/25								
Wall thickness	Material class	[kN]						
23	C30/37	[kN]	4.00	4.50	-	-		
	C35/45	[kN]	2.00	4.50	-	-		
	C45/55	[kN]	2.00	4.50	-	-		
	C50/60	[kN]	2.00	4.50	-	-		
35	C30/37	[kN]	6.50	11.00	16.00	-		
	C35/45	[kN]	7.00	12.00	17.00	-		
	C45/55	[kN]	8.00	14.00	19.00	-		
	C50/60	[kN]	8.50	15.00	20.00	-		
40	C30/37	[kN]	7.00	16.00	19.00	24.00		
	C35/45	[kN]	8.00	18.00	20.00	28.00		
	C45/55	[kN]	8.50	20.00	22.00	30.00		
	C50/60	[kN]	9.50	22.00	24.00	32.00		
50	C20/25	[kN]	8.00	8.50	8.50	8.50	8.50	8.50
Beam-and-block floor (eg.Terriva 4.0/2), min. 25mm wall thickness		[kN]	1.20	2.00	-	-	-	
Lightweight concrete LAC class 5		[kN]	5.50	5.50	5.50	5.50	-	
Solid clay brick class 20		[kN]	6.00	6.00	6.00	6.00	-	
Silicate hollow block class 15		[kN]	1.50	-	-	-	-	
SHEAR LOAD V_{Rk}								
Hollow core slab min. C20/25								
Wall thickness	Material class	[kN]						
23	C30/37	[kN]	4.00	4.50	-	-		
	C35/45	[kN]	2.00	4.50	-	-		
	C45/55	[kN]	2.00	4.50	-	-		
	C50/60	[kN]	2.00	4.50	-	-		
35	C30/37	[kN]	5.00	9.00	14.00	-		
	C35/45	[kN]	5.00	9.00	14.00	-		
	C45/55	[kN]	5.00	9.00	14.00	-		
	C50/60	[kN]	5.00	9.00	14.00	-		
40	C30/37	[kN]	5.00	9.00	14.00	20.00		
	C35/45	[kN]	5.00	9.00	14.00	20.00		
	C45/55	[kN]	5.00	9.00	14.00	20.00		
	C50/60	[kN]	5.00	9.00	14.00	20.00		
50	C20/25	[kN]	5.00	8.50	8.50	8.50	8.50	8.50
Beam-and-block floor (eg.Terriva 4.0/2), min. 25mm wall thickness		[kN]	1.20	2.00	-	-	-	
Lightweight concrete LAC class 5		[kN]	5.00	5.50	5.50	5.50	-	
Solid clay brick class 20		[kN]	5.00	6.00	6.00	6.00	-	
Silicate hollow block class 15		[kN]	1.50	-	-	-	-	

R-RB Rawlbolt® FOR USE IN HOLLOW CORE SLAB AND CERAMIC SUBSTRATES

BASIC PERFORMANCE DATA (cont.)

Size	M6	M8	M10	M12	M16	M20	
DESIGN LOAD							
TENSION LOAD N_{rd}							
Hollow core slab min. C20/25							
Wall thickness	Material class						
23	C30/37	[kN]	2.20	2.50	-	-	
	C35/45	[kN]	1.10	2.50	-	-	
	C45/55	[kN]	1.10	2.50	-	-	
	C50/60	[kN]	1.10	2.50	-	-	
35	C30/37	[kN]	3.60	6.10	8.90	-	
	C35/45	[kN]	3.90	6.70	9.40	-	
	C45/55	[kN]	4.40	7.80	10.60	-	
	C50/60	[kN]	4.70	8.30	11.10	-	
40	C30/37	[kN]	3.90	8.90	10.60	13.30	
	C35/45	[kN]	4.40	10.00	11.10	15.60	
	C45/55	[kN]	4.70	11.10	12.20	16.70	
	C50/60	[kN]	5.30	12.20	13.30	17.80	
50	C20/25	[kN]	4.40	4.70	4.70	4.70	4.70
Beam-and-block floor (eg.Terriva 4.0/2), min. 25mm wall thickness	[kN]	0.70	1.10	-	-	-	
Lightweight concrete LAC class 5	[kN]	2.00	2.20	2.20	2.20	-	
[English]: Cegła ceramiczna pełna 20MPa	[kN]	2.00	2.40	2.40	2.40	-	
Silicate hollow block class 15	[kN]	0.60	-	-	-	-	
SHEAR LOAD V_{rd}							
Hollow core slab min. C20/25							
Wall thickness	Material class						
23	C30/37	[kN]	3.20	3.60	-	-	
	C35/45	[kN]	1.60	3.60	-	-	
	C45/55	[kN]	1.60	3.60	-	-	
	C50/60	[kN]	1.60	3.60	-	-	
35	C30/37	[kN]	4.00	7.20	11.20	-	
	C35/45	[kN]	4.00	7.20	11.20	-	
	C45/55	[kN]	4.00	7.20	11.20	-	
	C50/60	[kN]	4.00	7.20	11.20	-	
40	C30/37	[kN]	4.00	7.20	11.20	16.00	
	C35/45	[kN]	4.00	7.20	11.20	16.00	
	C45/55	[kN]	4.00	7.20	11.20	16.00	
	C50/60	[kN]	4.00	7.20	11.20	16.00	
50	C20/25	[kN]	4.00	6.80	6.80	6.80	6.80
Beam-and-block floor (eg.Terriva 4.0/2), min. 25mm wall thickness	[kN]	1.00	1.60	-	-	-	
Lightweight concrete LAC class 5	[kN]	4.00	4.40	4.40	4.40	-	
[English]: Cegła ceramiczna pełna 20MPa	[kN]	4.00	4.80	4.80	4.80	-	
Silicate hollow block class 15	[kN]	1.20	-	-	-	-	
RECOMMENDED LOAD							
TENSION LOAD N_{rec}							
Hollow core slab min. C20/25							
Wall thickness	Material class						
23	C30/37	[kN]	1.60	1.80	-	-	
	C35/45	[kN]	0.80	1.80	-	-	
	C45/55	[kN]	1.60	1.80	-	-	
	C50/60	[kN]	0.80	1.80	-	-	
35	C30/37	[kN]	2.60	4.40	6.30	-	
	C35/45	[kN]	2.80	4.80	6.70	-	
	C45/55	[kN]	3.20	5.60	7.50	-	
	C50/60	[kN]	3.40	6.00	7.90	-	
40	C30/37	[kN]	2.80	6.30	7.50	9.50	
	C35/45	[kN]	3.20	7.10	7.90	11.10	
	C45/55	[kN]	3.40	7.90	8.70	11.90	
	C50/60	[kN]	3.80	8.70	9.50	12.70	
50	C20/25	[kN]	3.20	3.40	3.40	3.40	3.40
Beam-and-block floor (eg.Terriva 4.0/2), min. 25mm wall thickness	[kN]	0.50	0.80	-	-	-	
Lightweight concrete LAC class 5	[kN]	1.40	1.60	1.60	1.60	-	
[English]: Cegła ceramiczna pełna 20MPa	[kN]	1.40	1.70	1.70	1.70	-	
Silicate hollow block class 15	[kN]	0.40	-	-	-	-	

R-RB Rawlbolt® FOR USE IN HOLLOW CORE SLAB AND CERAMIC SUBSTRATES

BASIC PERFORMANCE DATA (cont.)

Size	M6	M8	M10	M12	M16	M20	
SHEAR LOAD V_{rec}							
Hollow core slab min. C20/25							
Wall thickness	Material class						
23	C30/37	[kN]	2.30	2.60	-	-	
	C35/45	[kN]	1.10	2.60	-	-	
	C45/55	[kN]	1.10	2.60	-	-	
	C50/60	[kN]	1.10	2.60	-	-	
35	C30/37	[kN]	2.90	5.10	8.00	-	
	C35/45	[kN]	2.90	5.10	8.00	-	
	C45/55	[kN]	2.90	5.10	8.00	-	
	C50/60	[kN]	2.90	5.10	8.00	-	
40	C30/37	[kN]	2.90	5.10	8.00	11.40	
	C35/45	[kN]	2.90	5.10	8.00	11.40	
	C45/55	[kN]	2.90	5.10	8.00	11.40	
	C50/60	[kN]	2.90	5.10	8.00	11.40	
50	C20/25	[kN]	2.90	4.90	4.90	4.90	4.90
Beam-and-block floor (eg.Terriva 4.0/2), min. 25mm wall thickness	[kN]	0.70	1.10	-	-	-	
Lightweight concrete LAC class 5	[kN]	2.90	3.10	3.10	3.10	-	
[English]: Cegła ceramiczna pełna 20MPa	[kN]	2.90	3.40	3.40	3.40	-	
Silicate hollow block class 15	[kN]	0.90	-	-	-	-	



Lightweight Fixings

R-FF1 Nylon frame fixing countersunk	283
R-FFS Frame fixing with the shortest anchoring zone	286
UNO® Universal plug with screw	288
4ALL Universal nylon plug with screw	290
GS Ceiling wedge anchor	293
R-FX-N Nylon hammer-in fixing	295

OVERVIEW OF OUR RANGE LIGHTWEIGHT FIXINGS SELECTOR

Mechanical ANCHORS		R-FF1	R-FFS	4ALL	UNO®	GS	FX						
MATERIAL	ZINC PLATED STEEL	✓	✓	✓	✓	✓	✓						
	ZINC FLAKED STEEL	✓	✓	-	-	-	-						
	HOT DIP GALVANIZED STEEL	-	-	-	-	-	-						
	STAINLESS STEEL	✓	✓	-	-	-	-						
SUBSTRATES	CONCRETE	✓	✓	✓	✓	✓	✓						
	CRACKED CONCRETE	✓	✓	-	-	✓	-						
	STONE	✓	✓	✓	-	✓	-						
	HOLLOW CONCRETE SLAB	✓	✓	✓	✓	-	-						
	SOLID BRICK	✓	✓	✓	✓	-	✓						
	SANDLIME SOLID BRICK	✓	✓	✓	✓	-	✓						
	HOLLOW BRICK	✓	✓	✓	✓	-	-						
	SANDLIME HOLLOW BRICK	✓	✓	✓	✓	-	-						
	LIGHTWEIGHT CONCRETE BLOCKS	✓	✓	✓	✓	-	-						
	AERATED CONCRETE	✓	✓	✓	✓	-	✓						
	PLASTERBOARD	-	-	✓	✓	-	-						
	APPROVALS	ETA CE	✓	✓	-	-	✓	✓					
CE		✓	✓	-	-	✓	-						
CE		-	-	-	-	-	-						
NATIONAL APPROVAL		-	-	✓	✓	-	-						
DESIGN TENSION AND SHEAR LOADS IN kN	[kN]	Ø8	Ø8	Ø10	Ø10	Ø5	Ø5	Ø5	Ø5	Ø6	Ø6	Ø5-8	Ø5-6
	0.2												
	0.4		Ø14										
	0.6												
	0.8												
	1.0												
	1.2												
	1.4												
	1.6												
	1.8												
	2.0												
	2.2			Ø10									
	2.4												
2.6													
2.8													
3.0					Ø14								
3.4													
3.8													
4.2													
4.6	Ø10												
5.0													

R-FF1 NYLON FRAME FIXING

Universal frame fixing for many applications



Nylon frame fixing countersunk
R-FF1-L

Nylon frame fixing with collar hex head
R-FF1-K



FEATURES AND BENEFITS

- The stainless steel screw for best anti-corrosion protection and external applications
- The countersunk plug for flush fixing of soft material (eg. timber)
- Specially-formulated nylon allows best performance installation for use in all base material categories according to ETAG 020 (A, B, C, D)
- Internal plug geometry designed to fit the screw head
- Plug design ensures multi-axis expansion

APPLICATIONS

- Door and window frames
- Garage doors
- Gates
- Industrial doors
- Facade (substructures made of wood and metal)
- Wall cabinets
- Satellite dishes
- Shelves
- Handrails
- Cable trays

BASE MATERIALS

- Approved for use in:
- Concrete ≥ C12/15
 - Solid Brick
 - Solid Sand-lime Brick
 - Hollow Brick
 - Hollow Sand-lime Brick
 - Hollow Lightweight Concrete Block
 - Aerated Concrete Block

INSTALLATION GUIDE

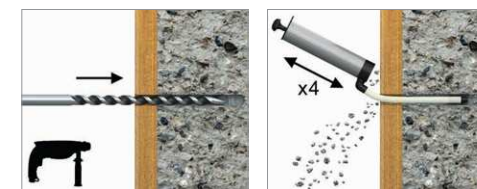

1. Drill a hole of required diameter and depth

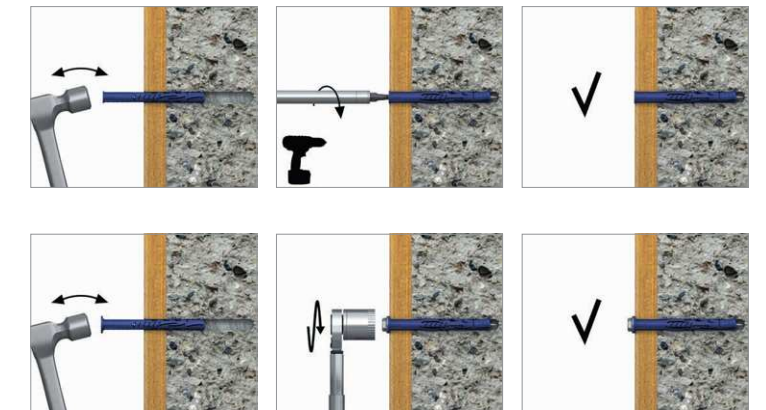

1. With a hammer, lightly tap the plug through the fixture into hole until fixing depth is reached
2. Tighten the FF1 screw

R-FF1 NYLON FRAME FIXING

PRODUCT INFORMATION (cont.)

R-FF1-N-L NYLON FRAME FIXING COUNTERSUNK

Size	Product Code			Plug [mm]		Screw [mm]		Fixture [mm]		
				Diameter	Length	Diameter	Length	Max. thickness		Hole diameter
				d	L	d ₁	L ₁	t _{fix} 50	t _{fix} 70	d _f
Ø8	R-FF1-N-L-A4	R-FF1-N-L-ZF	R-FF1-N-L	7.8	80	5.8	87	30	10	8
	R-FF1-N-08L080-A4	R-FF1-N-08L080/ZF	R-FF1-N-08L080	7.8	80	5.8	87	30	10	8
	R-FF1-N-08L100-A4	R-FF1-N-08L100/ZF	R-FF1-N-08L100	7.8	100	5.8	107	50	30	8
	R-FF1-N-08L120-A4	R-FF1-N-08L120/ZF	R-FF1-N-08L120	7.8	120	5.8	127	70	50	8
	-	R-FF1-N-08L140/ZF	R-FF1-N-08L140	7.8	140	5.8	147	90	70	8
Ø10	-	R-FF1-N-08L160/ZF	R-FF1-N-08L160	7.8	160	5.8	167	110	90	8
	R-FF1-N-10L080-A4	R-FF1-N-10L080/DT	R-FF1-N-10L080	9.8	80	7	87	30	10	10
	R-FF1-N-10L100-A4	R-FF1-N-10L100/DT	R-FF1-N-10L100	9.8	100	7	107	50	30	10
	R-FF1-N-10L120-A4	R-FF1-N-10L120/DT	R-FF1-N-10L120	9.8	120	7	127	70	50	10
	R-FF1-N-10L140-A4	R-FF1-N-10L140/DT	R-FF1-N-10L140	9.8	140	7	147	90	70	10
	R-FF1-N-10L160-A4	R-FF1-N-10L160/DT	R-FF1-N-10L160	9.8	160	7	167	110	90	10
	R-FF1-N-10L200-A4	R-FF1-N-10L200/DT	R-FF1-N-10L200	9.8	200	7	207	150	130	10
	R-FF1-N-10L240-A4	R-FF1-N-10L240/DT	R-FF1-N-10L240	9.8	240	7	247	190	170	10
	R-FF1-N-10L300-A4	R-FF1-N-10L300/DT	R-FF1-N-10L300	9.8	300	7	307	250	230	10

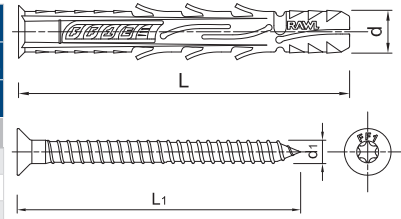

R-FF1-N-K NYLON FRAME FIXING COUNTERSUNK

Size	Product Code			Plug [mm]		Screw [mm]		Fixture [mm]		
				Diameter	Length	Diameter	Length	Max. thickness		Hole diameter
				d	L	d ₁	L ₁	t _{fix} 50	t _{fix} 70	d _f
Ø10	R-FF1-N-K-A4	R-FF1-N-K-DT	R-FF1-N-K	9.8	80	7	89	30	10	10
	R-FF1-N-10K080-A4	R-FF1-N-10K080/DT	R-FF1-N-10K080	9.8	80	7	89	30	10	10
	R-FF1-N-10K100-A4	R-FF1-N-10K100/DT	R-FF1-N-10K100	9.8	100	7	109	50	30	10
	R-FF1-N-10K120-A4	R-FF1-N-10K120/DT	R-FF1-N-10K120	9.8	120	7	129	70	50	10
	R-FF1-N-10K140-A4	R-FF1-N-10K140/DT	R-FF1-N-10K140	9.8	140	7	149	90	70	10
	R-FF1-N-10K160-A4	R-FF1-N-10K160/DT	R-FF1-N-10K160	9.8	160	7	169	110	90	10
	R-FF1-N-10K200-A4	R-FF1-N-10K200/DT	R-FF1-N-10K200	9.8	200	7	209	150	130	10
	R-FF1-N-10K240-A4	R-FF1-N-10K240/DT	R-FF1-N-10K240	9.8	240	7	249	190	170	10
	R-FF1-N-10K300-A4	R-FF1-N-10K300/DT	R-FF1-N-10K300	9.8	300	7	309	250	230	10
	Ø14	-	-	R-FF1-N-14K120	13.8	120	10.8	131	-	50
-		-	R-FF1-N-14K160	13.8	160	10.8	171	-	90	14
-		-	R-FF1-N-14K200	13.8	200	10.8	211	-	130	14
-		-	R-FF1-N-14K240	13.8	240	10.8	251	-	170	14

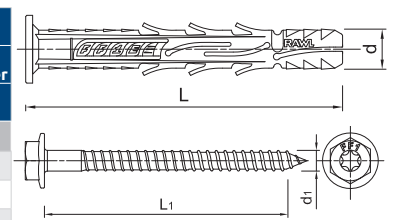

INSTALLATION DATA (cont.)

FF1-L

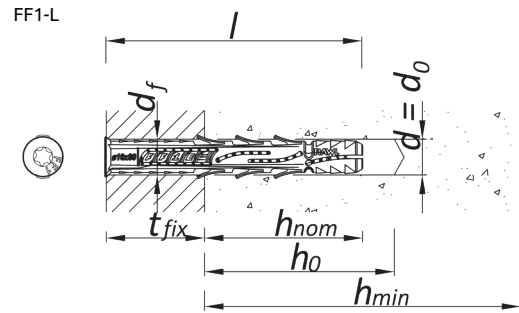

FF1-K

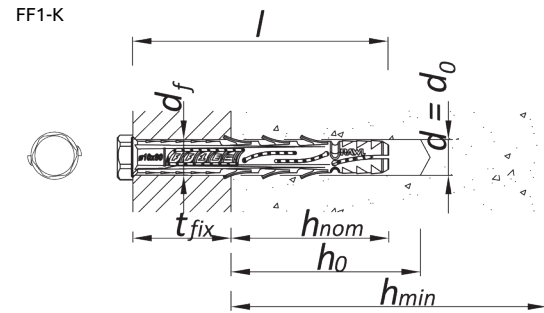

Substrate	A,B,C	D	A,B,C	A,B,C	D		
Hole diameter in substrate	d ₀	[mm]	8	8	10	10	10
Min. hole depth in substrate	h ₀	[mm]	60	80	60	80	80
Min. installation depth	h _{nom}	[mm]	50	70	50	70	70
Min. substrate thickness	h _{min}	[mm]	100	100	100	100	100
Min. spacing	s _{min}	[mm]	60	200	90	95	70
Min. edge distance	c _{min}	[mm]	60	100	80	80	70
Max. installation torque	T _{inst}	[Nm]	9	3.6	16	16	4.3
Screw drive	-	[-]	T30	T30	T40	T40	T40
Diameter	d	[mm]	8	8	10	10	10
Effective embedment depth	h _{ef}	[mm]	50	70	50	70	70

R-FF1 NYLON FRAME FIXING

BASIC PERFORMANCE DATA

Performance data for single fixing without influence of edge distance and spacing

Substrate	CHARACTERISTIC LOAD F _{Rk}															
	Concrete C12/15	Concrete min. C16/20	Solid brick min. 50MPa	Solid clay brick min 20MPa (eg Mz20/Z.0)	Sand-lime brick min. 30MPa	Solid silicate brick min 20MPa (eg KS NF 20/Z.0)	Perforated ceramic blocks min 15MPa (eg MEGA MAX)	Perforated ceramic blocks min 15MPa (eg Wienerberger Porotherm)	Sand-lime hollow block min. 20MPa	Lightweight concrete hollow block min 2.0MPa	Hollow brick min. 12MPa	Hollow brick min. 15MPa	Hollow clay block min. 7.5MPa	Autoclaved aerated concrete AAC 2	Autoclaved aerated concrete AAC 6	
Ø8, Embedment depth 50 mm	[kN]	1.50	2.00	-	1.50	-	1.50	0.75	0.40	0.50	0.90	0.60	1.20	-	-	
Ø8, Embedment depth 70 mm	[kN]	-	-	-	-	-	-	-	-	-	-	-	-	0.40	0.90	
Ø10, Embedment depth 50 mm	[kN]	1.20	2.00	-	1.50	-	-	-	-	-	-	-	-	-	-	
Ø10, Embedment depth 70 mm	[kN]	6.00	8.50	5.00	-	-	-	1.50	1.50	3.50	0.90	0.90	0.75	0.75	0.40	0.90
DESIGN LOAD F _{Ed}																
Ø8, Embedment depth 50 mm	[kN]	0.83	1.11	-	0.60	-	0.60	0.30	0.16	0.20	0.36	0.24	0.48	-	-	
Ø8, Embedment depth 70 mm	[kN]	-	-	-	-	-	-	-	-	-	-	-	-	0.20	0.45	
Ø10, Embedment depth 50 mm	[kN]	0.67	1.11	-	-	0.60	-	-	-	-	-	-	-	-	-	
Ø10, Embedment depth 70 mm	[kN]	4.28	4.72	2.00	-	-	-	0.60	0.60	1.40	0.36	0.36	0.30	0.30	0.20	0.45
RECOMMENDED LOAD F _{rc}																
Ø8, Embedment depth 50 mm	[kN]	0.60	0.79	-	0.43	-	0.43	0.21	0.11	0.14	0.26	0.17	0.34	-	-	
Ø8, Embedment depth 70 mm	[kN]	-	-	-	-	-	-	-	-	-	-	-	-	0.14	0.32	
Ø10, Embedment depth 50 mm	[kN]	0.48	0.79	-	-	0.43	-	-	-	-	-	-	-	-	-	
Ø10, Embedment depth 70 mm	[kN]	3.06	3.37	1.43	-	-	-	0.43	0.43	1.00	0.26	0.26	0.21	0.21	-	0.32

R-FFS FRAME FIXING WITH THE SHORTEST ANCHORING ZONE

Universal frame fixing with collar and hex head screw for many applications



Frame fixing with the shortest anchoring zone and collar hex head - stainless steel
R-FFS-K-A4

Frame fixing with the shortest anchoring zone and collar hex head - zinc plated
R-FFS-K



FEATURES AND BENEFITS

- Specially-formulated nylon allows best performance installation for use in all base material categories according to ETAG 020 (A, B, C, D)
- Internal plug geometry designed to fit the screw head
- Plug design ensures multi-axis expansion
- Collared plug for fixing of hard materials (eg. steel)
- Shortest anchoring depth - only 40/50 mm
- Frame fixing made of A4 steel intended for outdoor use
- Quick assembly thanks to the short anchoring zone and the possibility of using a punch-tool in aerated concrete

APPLICATIONS

- Ventilated facades
- Door and window frames
- Garage doors
- Gates
- Industrial doors
- Facade (substructures made of wood and metal)
- Wall cabinets
- Satellite dishes
- Shelves
- Handrails
- Cable trays

BASE MATERIALS

- Approved for use in:
- Cracked concrete \geq C12/15 (Use category A)
 - Solid Brick (Use category B)
 - Solid Sand-lime Brick (Use category B)
 - Hollow Sand-lime Brick (Use category C)
 - Hollow Brick (Use category C)
 - Hollow Lightweight Concrete
 - Block (Use category D)
 - Aerated Concrete Block (Use category D)
 - Concrete \geq C12/15 (Use category A)

INSTALLATION GUIDE



1. Drill a hole of required diameter and depth (figure 1 - base material A,B,C,D) or use punch-tool in aerated concrete (figure 2 - base material D)
2. With a hammer, lightly tap the plug through the fixture into hole until fixing depth is reached
3. Tighten the R-FFS screw

R-FFS FRAME FIXING WITH THE SHORTEST ANCHORING ZONE

PRODUCT INFORMATION

Size	Product Code	R-FFS-K	Plug [mm]		Screw [mm]		Fixture [mm]
			Diameter	Length	Diameter	Length	Hole diameter
			d	L	d ₁	L ₁	d _f
Ø10	R-FFS-10K050-A4	R-FFS-10K050	10	50	7	59	10
	R-FFS-10K060-A4	R-FFS-10K060	10	60	7	69	10
	R-FFS-10K080-A4	R-FFS-10K080	10	80	7	89	10
	R-FFS-10K100-A4	R-FFS-10K100	10	100	7	109	10
	R-FFS-10K120-A4	R-FFS-10K120	10	120	7	129	10

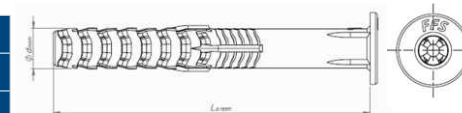

INSTALLATION DATA

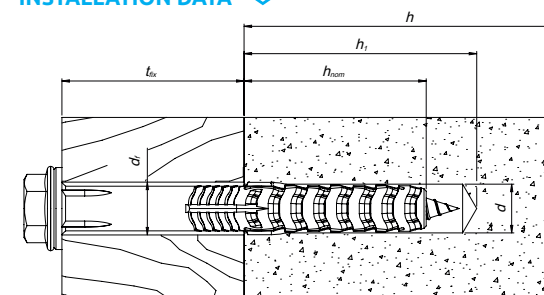

Substrate		Ø10	Ø10	
Hole diameter in substrate	d ₀	[mm]	10	10
Min. hole depth in substrate	h ₀	[mm]	50	60
Min. installation depth	h _{nom}	[mm]	40	50
Min. substrate thickness	h _{min}	[mm]	100	100
Min. spacing	s _{min}	[mm]	70	80
Min. edge distance	c _{min}	[mm]	50	70
Head size	s _w	[mm]	13	13
Screw drive	-	[-]	T40	T40
Effective embedment depth	h _{ef}	[mm]	40	45

BASIC PERFORMANCE DATA

Performance data for single fixing without influence of edge distance and spacing

Substrate		Concrete C12/15	Concrete C16/20	Solid clay brick min 20MPa (eg Mz20/2.0)	Sand-lime brick 40MPa	Sand-lime hollow block min. 20MPa	Perforated ceramic brick HLzB 5MPa	Silicate hollow block min 12MPa (eg KS Ratio Block 8 DF)	Hollow lightweight aggregate concrete 4MPa	Autoclaved aerated concrete AAC 4MPa
CHARACTERISTIC LOAD F_{Rk}										
Ø10, Embedment depth 40 mm	[kN]	30.50	4.00	-	-	-	-	-	-	-
Ø10, Embedment depth 50 mm	[kN]	-	-	2.00	3.50	4.00	0.60	2.00	0.75	1.50
DESIGN LOAD F_{Ed}										
Ø10, Embedment depth 40 mm	[kN]	1.66	2.22	-	-	-	-	-	-	-
Ø10, Embedment depth 50 mm	[kN]	-	-	0.80	1.40	1.60	0.24	0.80	0.30	0.75
RECOMMENDED LOAD F_{rec}										
Ø10, Embedment depth 40 mm	[kN]	1.19	1.59	-	-	-	-	-	-	-
Ø10, Embedment depth 50 mm	[kN]	-	-	0.57	1.00	1.14	0.17	0.57	0.21	0.53

UNO® UNIVERSAL PLUG

Truly universal plug which fixes into any base material, solid or hollow

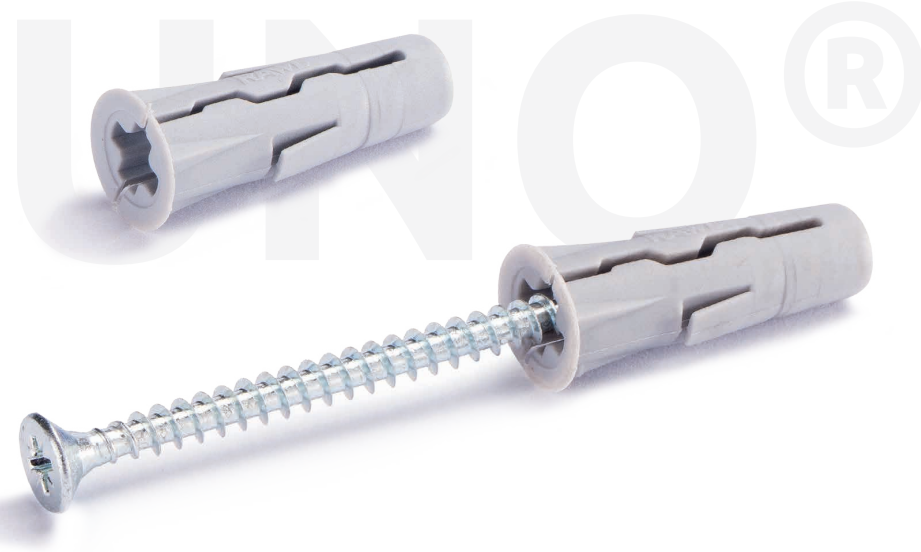

Universal plug
UNO-K

Universal plug
with screw
UNO®



FEATURES AND BENEFITS

- Unique geometry guarantees maximum expansion and grip
- Instant grip resulting from split plug design
- Anti-rotation features prevent spinning in the hole
- Lip prevents plug slipping into over-sized holes
- Recommended for uncertain substrates, irregular or worn-out holes
- Short length enables effective installation in thin walls ("partition walls")

APPLICATIONS

- Suspended ceilings
- Electrical fittings
- Cable trays
- Boilers
- Radiators
- Lighting
- Bathroom fittings

BASE MATERIALS

- Suitable for use in:
- Concrete
 - Hollow-core Slab
 - High-Density Natural Stone
 - Solid Brick
 - Solid Sand-lime Brick
 - Hollow Brick
 - Vertically-perforated clay block
 - Lightweight Concrete Block
 - Hollow Lightweight Concrete Block
 - Aerated Concrete Block
 - Plasterboard

INSTALLATION GUIDE

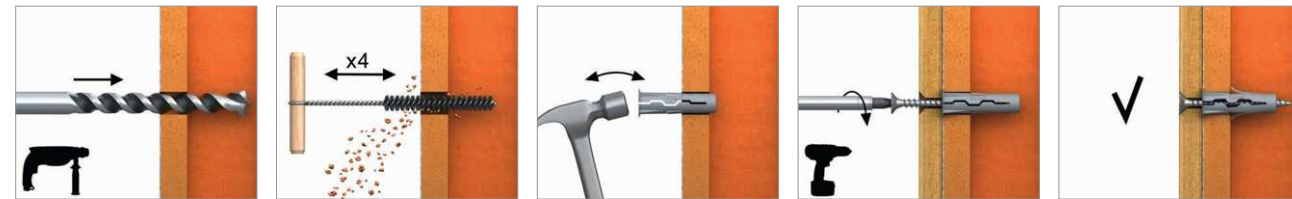

1. Drill a hole of required diameter.
2. Insert UNO plug into hole and tap home.
3. Insert screw of required diameter into plug through fixture and tighten.

UNO® UNIVERSAL PLUG

PRODUCT INFORMATION

Size	Product Code	Plug		Screw		Fixture	
		Diameter	Length	Diameter	Length	Max. thickness	Hole diameter
		d [mm]	L [mm]	D [mm]	L [mm]	t _{fix} [mm]	d _f [mm]
Universal plug							
Ø5	UNO-K-05	5	24	-	-	-	4.0 - 5.0
Ø6	UNO-K-06	6	28	-	-	-	4.0 - 6.0
Ø7	UNO-K-07	7	30	-	-	-	5.0 - 7.0
Ø8	UNO-K-08	8	32	-	-	-	5.0 - 7.0
Ø10	UNO-K-10	10	36	-	-	-	6.0 - 9.0
Universal plug with screw							
Ø5	UNO-05+330	5	24	3.5	30	6	6
Ø6	UNO-06+430	6	28	4.0	30	1	5
	UNO-06+435	6	28	4.0	35	5	5
	UNO-06+445	6	28	4.0	45	15	6
Ø8	UNO-08+435	8	32	4.5	35	2	5
	UNO-08+450	8	32	4.5	50	15	6
	UNO-08+560	8	32	5.0	60	25	7
Ø10	UNO-10+540	10	36	5.0	40	2	6
	UNO-10+650	10	36	6.0	50	15	7
	UNO-10+660	10	36	6.0	60	25	8

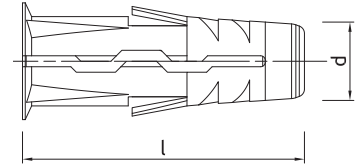

INSTALLATION DATA

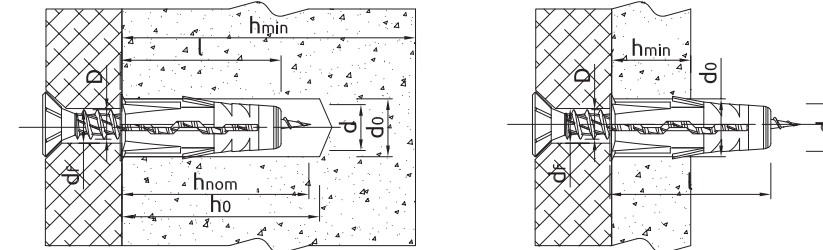

Size		Ø5	Ø6	Ø7	Ø8	Ø10
Thread diameter	d [mm]	5	6	7	8	10
Hole diameter in substrate	d ₀ [mm]	5	6	7	8	10
Min. hole depth in substrate	h ₀ [mm]	34	38	40	42	46
Min. installation depth	h _{nom} [mm]	24	28	30	32	36
Min. substrate thickness	h _{min} [mm]	50	55	60	65	70
Min. spacing	s _{min} [mm]	24	28	30	32	36
Min. edge distance	c _{min} [mm]	24	28	30	32	36

BASIC PERFORMANCE DATA

Performance data for single fixing without influence of edge distance and spacing

Substrate		CHARACTERISTIC LOAD F _{Rk}					
		Concrete C20/25	Solid brick	Sand-lime solid brick	Perforated ceramic brick	Sand-lime hollow brick	Plasterboard min. 12.5 mm
Ø5, Embedment depth 24mm	[kN]	0.60	1.50	1.50	0.60	1.50	0.17
Ø6, Embedment depth 28mm	[kN]	1.20	2.50	1.50	0.75	1.50	0.21
Ø7, Embedment depth 30mm	[kN]	1.20	3.00	3.00	0.90	3.50	0.24
Ø8, Embedment depth 32mm	[kN]	1.20	3.00	2.50	0.90	1.50	0.37
Ø10, Embedment depth 36mm	[kN]	2.50	4.00	0.90	0.90	1.20	0.34
DESIGN LOAD F _{sd}							
Ø5, Embedment depth 24mm	[kN]	0.33	0.60	0.60	0.24	0.60	0.08
Ø6, Embedment depth 28mm	[kN]	0.66	1.00	0.60	0.30	0.60	0.10
Ø7, Embedment depth 30mm	[kN]	0.66	1.20	1.20	0.36	1.40	0.12
Ø8, Embedment depth 32mm	[kN]	0.66	1.20	1.00	0.36	0.60	0.18
Ø10, Embedment depth 36mm	[kN]	1.38	1.60	0.36	0.36	0.48	0.17
RECOMMENDED LOAD F _{rec}							
Ø5, Embedment depth 24mm	[kN]	0.24	0.43	0.43	0.17	0.43	0.06
Ø6, Embedment depth 28mm	[kN]	0.47	0.71	0.43	0.21	0.43	0.07
Ø7, Embedment depth 30mm	[kN]	0.47	0.86	0.86	0.26	1.00	0.09
Ø8, Embedment depth 32mm	[kN]	0.47	0.86	0.71	0.26	0.43	0.13
Ø10, Embedment depth 36mm	[kN]	0.99	1.14	0.26	0.26	0.29	0.12

4ALL UNIVERSAL NYLON PLUG

High performance nylon plug for all types of substrates



Universal nylon plug
4ALL

Universal nylon plug with screw
4ALL



FEATURES AND BENEFITS

- Unique internal design provides positive grip for screws.
- Rib detail at plug head provides added grip.
- Expanding section designed to collapse in hollow materials and provide positive grip behind surfaces.
- Unique 4 way expansion allowing application in any substrate material and type.
- Solid head design provides strength whilst plug is installed.
- Anti-rotational lugs promote grip in wide range of substrates including soft masonry materials.

APPLICATIONS

- Lighting
- Wall cabinets
- Wardrobes
- Letterboxes
- TV brackets
- Bathroom fittings
- Electrical fittings
- Shelves

BASE MATERIALS

- Suitable for use in:
- Concrete
 - Hollow-core Slab
 - High-Density Natural Stone
 - Solid Brick
 - Hollow Brick
 - Vertically-perforated clay block
 - Lightweight Concrete Block
 - Hollow Lightweight Concrete Block
 - Aerated Concrete Block
 - Plasterboard

INSTALLATION GUIDE



1. Drill a hole of required diameter.
2. Insert 4ALL plug into hole and tap home.
3. Insert screw of required diameter into plug through fixture and tighten.

4ALL UNIVERSAL NYLON PLUG

PRODUCT INFORMATION

Size	Product Code	Plug		Screw		Fixture	
		Diameter	Length	Diameter	Length	Max. thickness	Hole diameter
		d [mm]	l [mm]	D [mm]	L [mm]	t _{fix} [mm]	d _f [mm]
Universal nylon plug 4ALL							
Ø5	4ALL-05	5	25	3,0 - 4,0	min. 25	4,0 - 5,0	-
Ø6	4ALL-06	6	30	4,0 - 5,0	min. 30	5,0 - 6,0	-
	4ALL-06050	6	50	4,0 - 5,0	min. 60	5,0 - 6,0	-
Ø8	4ALL-08	8	40	4,5 - 6,0	min. 40	6,0 - 8,0	-
	4ALL-08065	8	65	4,5 - 6,0	min. 70	6,0 - 8,0	-
Ø10	4ALL-10	10	50	6,0 - 8,0	min. 50	7,0 - 9,0	-
Ø12	4ALL-12	12	60	8,0 - 10,0	min. 60	9,0 - 11,0	-
Ø14	4ALL-14	14	70	10,0	min. 70	11,0	-
Universal nylon plug with screw 4ALL							
Ø5	4ALL-05+3530	5	25	3,5	30	10	4
Ø6	4ALL-06+4540	6	30	4,5	40	10	5
Ø8	4ALL-08+5060	8	40	5	60	20	6
Ø10	4ALL-10+6060	10	50	6	60	10	7
Ø12	4ALL-12/80	12	60	8	80	20	9
Ø12	4ALL-12/100	12	60	8	100	40	9
Ø14	4ALL-14/100	14	70	10	100	30	11
Ø6	4ALL-06050+4560	6	50	4,5	60	10	5
Ø8	4ALL-08065+5080	8	65	5	80	15	6

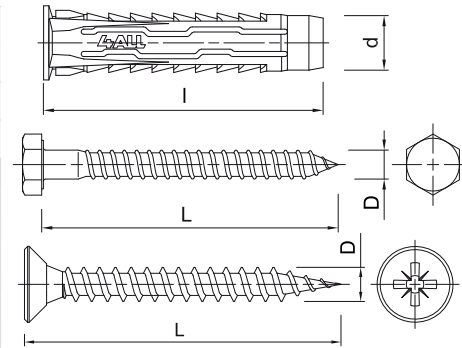

INSTALLATION DATA

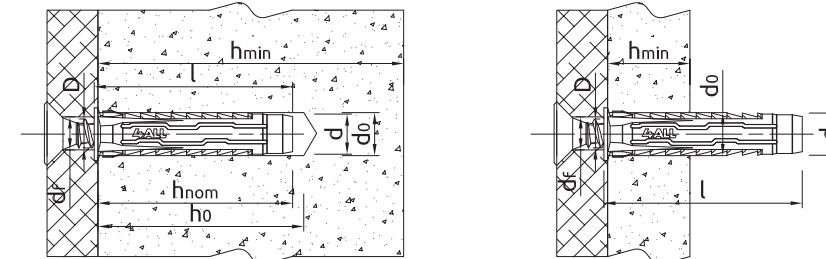

Size	Ø5	Ø6	Ø6 (50)	Ø8	Ø8 (50)	Ø10	Ø12	Ø14		
Fixing diameter	d	[mm]	5	6	6	8	8	10	12	14
Hole diameter in substrate	d ₀	[mm]	5	6	6	8	8	10	12	14
Min. hole depth in substrate	h ₀	[mm]	35	40	60	50	75	60	70	80
Min. installation depth	h _{nom}	[mm]	25	30	50	40	65	50	60	70
Min. substrate thickness	h _{min}	[mm]	65	70	80	80	100	90	100	100
Min. spacing	s _{min}	[mm]	25	30	40	40	50	50	60	70
Min. edge distance	c _{min}	[mm]	25	30	40	40	50	50	60	70

BASIC PERFORMANCE DATA

Performance data for single fixing without influence of edge distance and spacing

Substrate	CHARACTERISTIC LOAD F _{Rk}	Concrete C20/25 - C50/60	Solid clay brick min 20MPa (eg Mz20/Z2.0)	Sand-lime solid brick	Perforated brick 15MPa	Sand-lime hollow block min. 20MPa	Aerated concrete 600 Mark V	Plasterboard min. 12.5 mm	Plasterboard min. 2x12.5 mm
		Ø5, Embedment depth 25mm	[kN]	0.10	-	0.20	0.15	0.50	0.20
Ø6, Embedment depth 30mm	[kN]	0.20	0.15	0.60	0.30	0.60	0.30	0.12	-
Ø6, Embedment depth 50mm	[kN]	0.30	0.60	0.90	0.50	0.90	0.60	-	0.60
Ø8, Embedment depth 40mm	[kN]	0.50	0.75	0.90	0.50	0.75	0.50	0.15	-
Ø8, Embedment depth 65 mm	[kN]	0.50	0.50	0.60	0.90	0.90	0.50	-	0.75
Ø10, Embedment depth 50mm	[kN]	0.50	0.90	1.20	0.50	0.75	0.60	0.26	-
Ø12, Embedment depth 60mm	[kN]	4.50	4.00	7.00	2.50	4.50	3.50	-	0.66
Ø14, Embedment depth 70mm	[kN]	5.50	6.00	10.50	1.50	5.00	5.50	-	0.74

4ALL UNIVERSAL NYLON PLUG

BASIC PERFORMANCE DATA (cont.)

Substrate		Concrete C20/25 - C50/60	Solid clay brick min 20MPa (eg Mizzu/2.0)	Sand-lime solid brick	Perforated brick 15MPa	Sand-lime hollow block min. 20MPa	Aerated concrete 600 Mark V	Plasterboard min. 12.5 mm	Plasterboard min. 2x12.5 mm
DESIGN LOAD F_{Rd}									
Ø5, Embedment depth 25mm	[kN]	0.06	-	0.08	0.06	0.20	0.10	0.06	-
Ø6, Embedment depth 30mm	[kN]	0.11	0.06	0.24	0.12	0.24	0.15	0.06	-
Ø6, Embedment depth 50mm	[kN]	0.16	0.24	0.36	0.20	0.36	0.24	-	0.30
Ø8, Embedment depth 40mm	[kN]	0.28	0.30	0.36	0.20	0.30	0.25	0.08	-
Ø8, Embedment depth 65mm	[kN]	0.27	0.20	0.24	0.36	0.36	0.20	-	0.37
Ø10, Embedment depth 50mm	[kN]	0.28	0.36	0.48	0.20	0.30	0.30	0.13	-
Ø12, Embedment depth 60mm	[kN]	2.50	1.60	2.80	1.00	1.80	1.75	-	0.33
Ø14, Embedment depth 70mm	[kN]	3.06	2.40	4.20	0.60	2.00	2.75	-	0.37
RECOMMENDED LOAD F_{rec}									
Ø5, Embedment depth 25mm	[kN]	0.04	-	0.06	0.04	0.14	0.07	0.04	-
Ø6, Embedment depth 30mm	[kN]	0.08	0.04	0.17	0.09	0.17	0.11	0.04	-
Ø6, Embedment depth 50mm	[kN]	0.1143	0.17	0.26	0.14	0.26	0.17	-	0.21
Ø8, Embedment depth 40mm	[kN]	0.20	0.21	0.26	0.14	0.21	0.18	0.05	-
Ø8, Embedment depth 65mm	[kN]	0.1929	0.14	0.17	0.26	0.26	0.14	-	0.26
Ø10, Embedment depth 50mm	[kN]	0.20	0.26	0.34	0.14	0.21	0.21	0.09	-
Ø12, Embedment depth 60mm	[kN]	1.79	1.14	2.00	0.71	1.29	1.25	-	0.24
Ø14, Embedment depth 70mm	[kN]	2.18	1.71	3.00	0.43	1.43	1.96	-	0.26

GS CEILING WEDGE ANCHOR

Ceiling wire hanger for lightweight ceilings and suspended ceilings to solid building materials



FEATURES AND BENEFITS

- During installation, when the nail is flush with the head, it signifies the complete expansion of the anchor
- The two hit zone ensure correct installation (especially in narrow drill holes) and high safety in use.
- Approved for installation in cracked and non-cracked concrete.
- Fire resistance class A1
- Reliable setting thanks to the simple visual check
- Impact expansion by hammer, no setting tool is needed

APPLICATIONS

- Installation of lightweight ceilings and suspended ceilings
- Installation of coffered ceilings
- Installation of conduit and pipe clamps and other MEP applications
- Ventilation systems
- Metal roof profiles
- Punched straps

BASE MATERIALS

- Approved for use in:
- Cracked concrete C20/25-C50/60
 - Non-cracked concrete C20/25-C50/60

INSTALLATION GUIDE

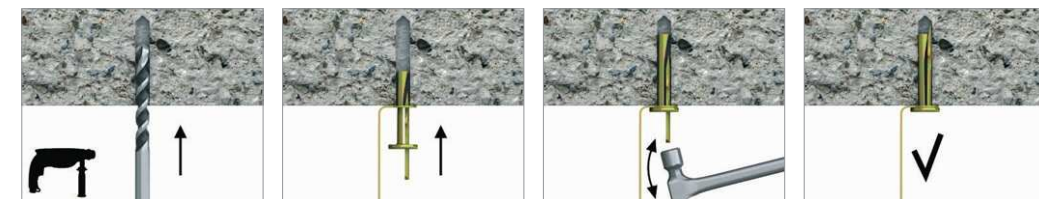

- Drill a hole of required diameter and depth
- Insert anchor through fixture into hole until fixing depth is reached.
- Hammer-in the nail until flush with head.
- Do not hit the expansion wedge at the stage.

PRODUCT INFORMATION

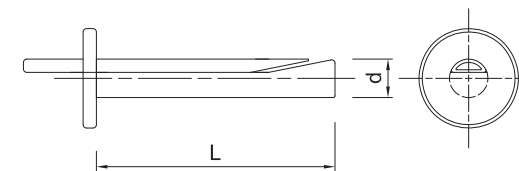

Size	Product Code	Anchor		Fixture	
		Diameter	Length	Max. thickness	Hole diameter
		d [mm]	l [mm]	t _{fix} [mm]	d _f [mm]
Ø6	R-GS-06040	5.8	36	4.5	7
	R-GS-06065	5.8	65	35	7

GS CEILING WEDGE ANCHOR

INSTALLATION DATA

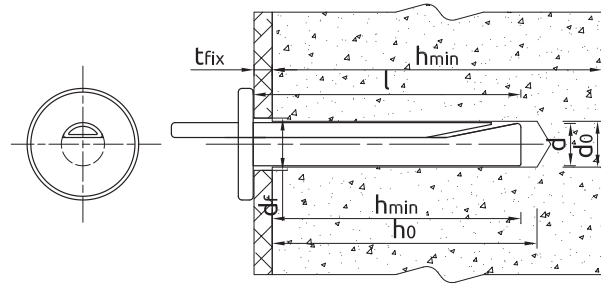

Size			Ø6
Fixing diameter	d	[mm]	5.8
Hole diameter in substrate	d ₀	[mm]	6
Min. hole depth in substrate	h ₀	[mm]	40
Min. installation depth	h _{nom}	[mm]	32
Min. substrate thickness	h _{min}	[mm]	100
Min. spacing	s _{min}	[mm]	200
Min. edge distance	c _{min}	[mm]	150

BASIC PERFORMANCE DATA

Performance data for single fixing without influence of edge distance and spacing

Substrate		Cracked concrete	Non-cracked concrete
CHARACTERISTIC LOAD F_{rk}			
Ø06, Effective embedment depth 32 mm	[kN]	3.00	3.00
DESIGN LOAD F_{rd}			
Ø06, Effective embedment depth 32 mm	[kN]	2.00	2.00
RECOMMENDED LOAD F_{rec}			
Ø06, Effective embedment depth 32 mm	[kN]	1.43	1.43

R-FX-N NYLON HAMMER-IN FIXINGS

The nylon hammer fixing with cylinder head for fast, simple, cost-effective installations



Nylon hammer-in fixing with cylinder head
FX-N-C

Nylon hammer-in fixing with mushroom head
FX-N-K

Nylon hammer-in fixing with countersunk head
FX-N-L



FEATURES AND BENEFITS

- Rapid hammer-set installation reduces the time required and allows for cost-effective, high-volume installation.
- Cylinder head prevents plug slipping into over-sized holes and allows fix thin elements
- Combination of PH recess and the helical thread makes removal of the nail possible, facilitating disassembly when necessary.
- The extensive range of product lengths, diameters and head types ensures availability of the correct fixing for every scenario.
- Designed for push-through installation.

APPLICATIONS

- Timber or metal battens
- Drywall structures
- Skirting / Dado railing
- Cable clamps
- Pipe clamps

BASE MATERIALS

- Approved for use in:
- Concrete
 - Solid Brick
 - Solid Sand-lime Brick
 - Hollow Sand-lime Brick
 - Lightweight Concrete Block
 - Hollow Lightweight Concrete Block
 - Aerated Concrete Block

INSTALLATION GUIDE



1. Drill a hole of required diameter.
2. Blow out dust at least 4 times with a hand pump.



R-FX-N NYLON HAMMER-IN FIXINGS

INSTALLATION GUIDE



1. Insert FX plug into hole through fixture.
2. Hammer the nail into the plastic sleeve until fixing is secure and flush with the fixture.

PRODUCT INFORMATION

FX-N-C NYLON HAMMER-IN FIXING WITH CYLINDER HEAD

Size	Product Code	Plug		Nail		Fixture		Diameter
		Diameter	Length	Diameter	Length	Max. thickness	Hole diameter	
		d [mm]	l [mm]	D [mm]	L [mm]	t _{fix} [mm]	d _f [mm]	
Ø6	R-FX-N-06K040	5.9	40	3.8	44	11	7	12.5
	R-FX-N-06K045	5.9	45	3.8	49	16	7	12.5
	R-FX-N-06K060	5.9	60	3.8	64	31	7	12.5
	R-FX-N-06K080	5.9	80	3.8	84	51	7	12.5

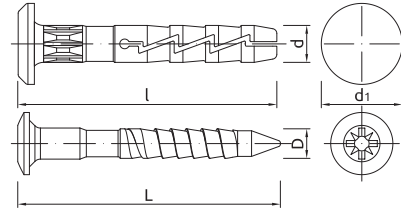

FX-N-K NYLON HAMMER-IN FIXING WITH MUSHROOM HEAD

Size	Product Code	Plug		Nail		Fixture		Diameter
		Diameter	Length	Diameter	Length	Max. thickness	Hole diameter	
		d [mm]	l [mm]	D [mm]	L [mm]	t _{fix} [mm]	d _f [mm]	
Ø5	R-FX-N-05C030	4.9	30	3.3	33	5	6	9
	R-FX-N-05C035	4.9	35	3.3	38	10	6	9
	R-FX-N-05C050	4.9	50	3.3	54	25	6	9
Ø6	R-FX-N-06C035	5.9	35	3.8	39	6	7	11
	R-FX-N-06C040	5.9	40	3.8	44	11	7	11
	R-FX-N-06C045	5.9	45	3.8	49	16	7	11
	R-FX-N-06C060	5.9	60	3.8	64	31	7	11
Ø8	R-FX-N-08C080	5.9	80	3.8	84	51	7	11
	R-FX-N-08C045	7.9	45	4.8	51	5	9	13.2
	R-FX-N-08C060	7.9	60	4.8	66	20	9	13.2
	R-FX-N-08C080	7.9	80	4.8	86	40	9	13.2
	R-FX-N-08C100	7.9	100	4.8	106	60	9	13.2
	R-FX-N-08C120	7.9	120	4.8	126	80	9	13.2
	R-FX-N-08C140	7.9	140	4.8	146	100	9	13.2
R-FX-N-08C160	7.9	160	4.8	166	120	9	13.2	

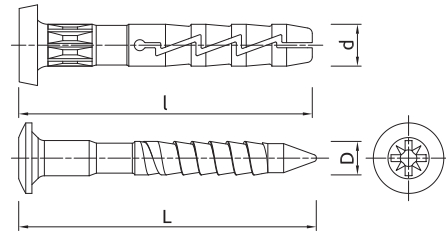

FX-N-K NYLON HAMMER-IN FIXING WITH MUSHROOM HEAD

Size	Product Code	Plug		Nail		Fixture		Diameter
		Diameter	Length	Diameter	Length	Max. thickness	Hole diameter	
		d [mm]	l [mm]	D [mm]	L [mm]	t _{fix} [mm]	d _f [mm]	
Ø5	R-FX-N-05L025	4.9	25	3.3	28	1	6	8.5
	R-FX-N-05L030	4.9	30	3.3	33	5	6	8.5
	R-FX-N-05L035	4.9	35	3.3	38	10	6	8.5
	R-FX-N-05L040	4.9	40	3.3	43	15	6	8.5
	R-FX-N-05L050	4.9	50	3.3	54	25	6	8.5
Ø6	R-FX-N-06L035	5.9	35	3.8	39	6	7	10
	R-FX-N-06L040	5.9	40	3.8	44	11	7	10
	R-FX-N-06L045	5.9	45	3.8	49	16	7	10
	R-FX-N-06L050	5.9	50	3.8	54	21	7	10
	R-FX-N-06L055	5.9	55	3.8	59	26	7	10
	R-FX-N-06L060	5.9	60	3.8	64	31	7	10
	R-FX-N-06L080	5.9	80	3.8	84	51	7	10
	R-FX-N-08L045	7.9	45	4.8	51	5	9	11.5
Ø8	R-FX-N-08L060	7.9	60	4.8	66	20	9	11.5
	R-FX-N-08L080	7.9	80	4.8	86	40	9	11.5
	R-FX-N-08L100	7.9	100	4.8	106	60	9	11.5
	R-FX-N-08L120	7.9	120	4.8	126	80	9	11.5
	R-FX-N-08L140	7.9	140	4.8	146	100	9	11.5
R-FX-N-08L160	7.9	160	4.8	166	120	9	11.5	

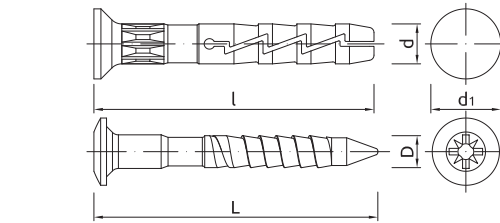

R-FX-N NYLON HAMMER-IN FIXINGS

INSTALLATION DATA (cont.)

FX-N-K

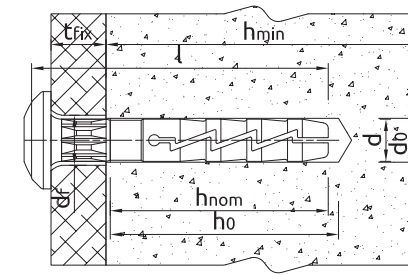

FX-N-C

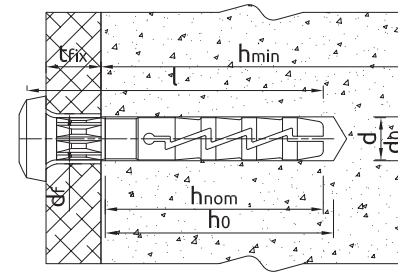

FX-N-L

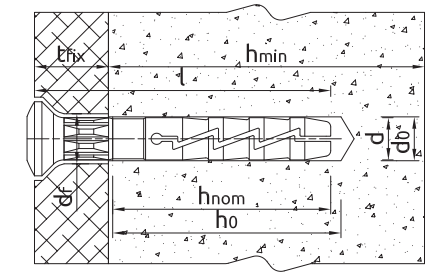

Size		Ø5	Ø6	Ø8
Fixing diameter	d [mm]	5	6	8
Hole diameter in substrate	d ₀ [mm]	5	6	8
Min. hole depth in substrate	h ₀ [mm]	30	35	45
Min. installation depth	h _{nom} [mm]	25	29	40
Min. substrate thickness	h _{min} [mm]	100	100	100
Min. spacing	s _{min} [mm]	100	100	100
Min. edge distance	c _{min} [mm]	100	100	100

BASIC PERFORMANCE DATA

Performance data for single fixing without influence of edge distance and spacing

Substrate		POLYAMIDE PLUG							
		Concrete C12/15	Concrete C20/25 - C50/60	Solid brick	Sand-lime solid brick	Sand-lime hollow brick	Lightweight concrete hollow block	Lightweight concrete block	Autoclaved aerated concrete
CHARACTERISTIC LOAD F_{rk}									
Ø5, Embedment depth 25mm	[kN]	0.20	0.30	0.20	0.20	0.30	0.20	0.20	-
Ø6, Embedment depth 29mm	[kN]	0.20	0.30	0.20	0.40	0.30	0.30	0.30	0.10
Ø8, Embedment depth 40mm	[kN]	0.30	0.50	0.50	0.40	-	0.30	0.50	0.10
DESIGN LOAD F_{rd}									
Ø5, Embedment depth 25mm	[kN]	0.15	0.15	0.10	0.10	0.15	0.10	0.10	-
Ø6, Embedment depth 29mm	[kN]	0.15	0.15	0.10	0.20	0.15	0.15	0.15	0.05
Ø8, Embedment depth 40mm	[kN]	0.25	0.25	0.25	0.20	-	0.15	0.25	0.05
RECOMMENDED LOAD F_{rec}									
Ø5, Embedment depth 25mm	[kN]	0.11	0.11	0.07	0.07	0.11	0.07	0.07	-
Ø6, Embedment depth 29mm	[kN]	0.11	0.11	0.07	0.14	0.11	0.11	0.11	0.04
Ø8, Embedment depth 40mm	[kN]	0.18	0.18	0.18	0.14	-	0.11	0.18	0.04

WIND LOADING & DESIGN CALCULATIONS

CALCULATION OF WIND LOADS

When designing structures and elements of façades and roofs, all forces must be taken into account.

When designing the mechanical fastening of façade elements, the decisive factor for the fastener is the effect of wind on the façade surface. The loads due to the weight of the elements should be calculated independently.

In the case of flat roofs wind and snow loading are particularly important, although snow loading does not have a direct effect on mechanical fixings. A critical factor for mechanically fastened systems on flat roofs is therefore the wind load.

For correct design and selection of fixing systems it is necessary to calculate all positive and negative pressures acting on areas of the roof due to wind. For this purpose the guidance in EN 1991-1-4 (Eurocode 1: Actions on structures - Part 1-4: General actions - Wind actions).

EN 1991-1-4 gives guidance on the determination of natural wind actions for the structural design of building and civil engineering works for each of the loaded areas under consideration. This includes the whole structure or parts of the structure or elements attached to the structure, e. g. components, cladding units and their fixings, safety and noise barriers.

Certain aspects necessary to determine wind actions on a structure are dependent on the location and on the availability and quality of meteorological data, the type of terrain, etc. These need to be provided in the National Annex which should be an integral part of this standard.

Examples of national wind distribution maps are shown in Figures 1 to 8

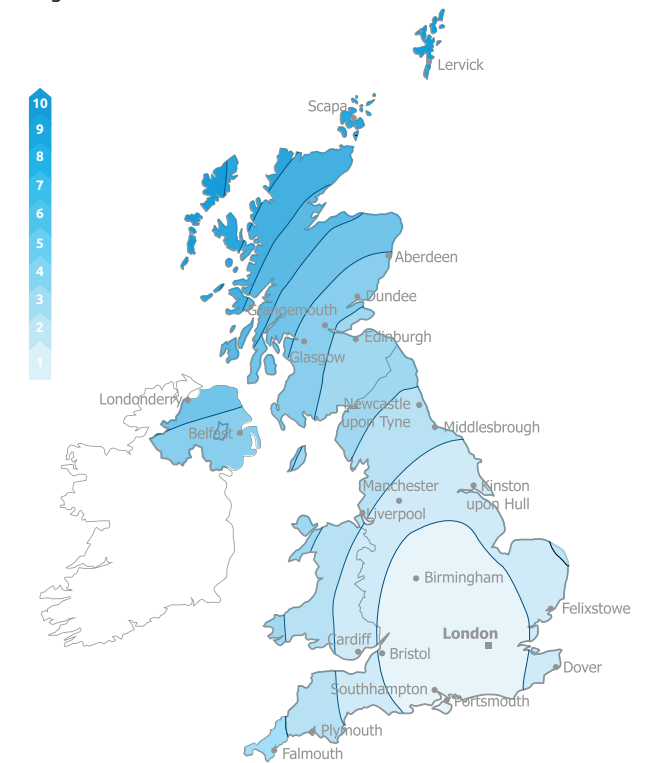

Fig. 1 - Wind map for United Kingdom

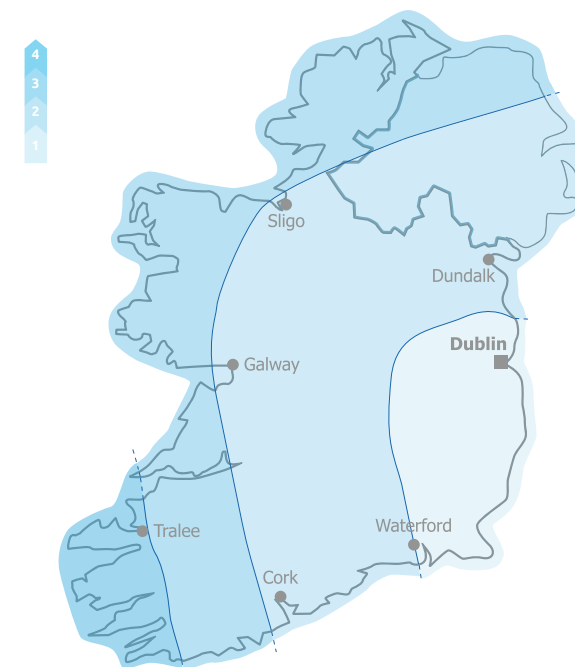

Fig. 2 - Wind map for Ireland



Fig. 3 - Wind map for Poland

Basics to façade & roofing fixings

WIND LOADING & DESIGN CALCULATIONS

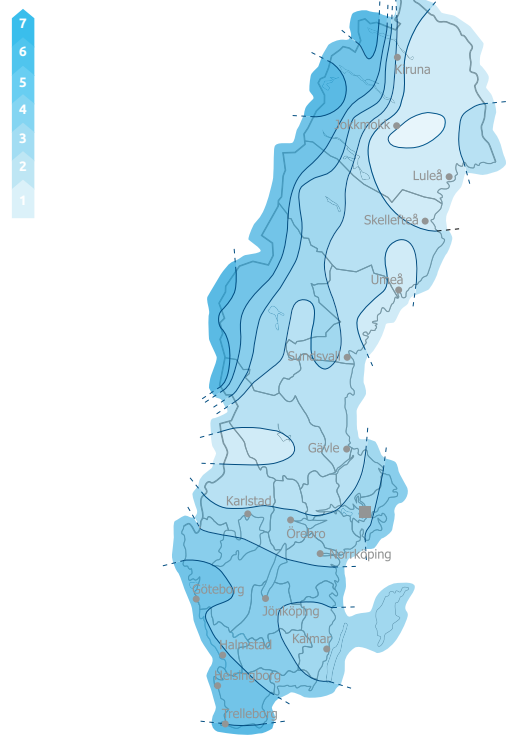

Fig. 4 - Wind map for Sweden



Fig. 5 - Wind map for the Czech Republic

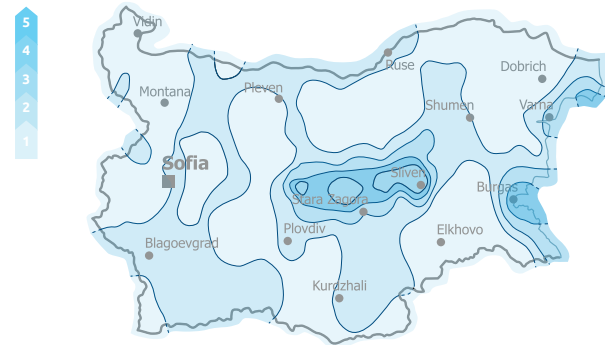

Fig. 6 - Wind map for Bulgaria

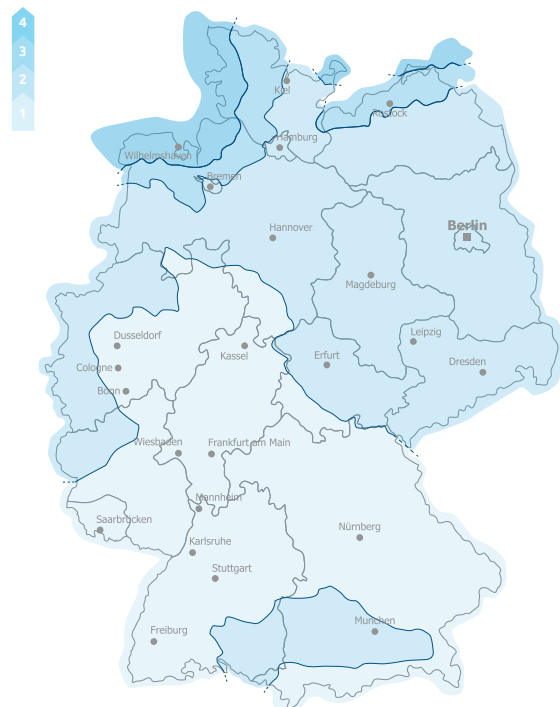

Fig. 7 - Wind map for Germany



Fig. 8 - Wind map for Denmark

WIND LOADING & DESIGN CALCULATIONS

The base wind speed should be modified to take account of the wind direction and season.

Fundamental basic wind velocity is the 10 minute mean wind velocity with an annual risk of being exceeded of 0.02, irrespective of wind direction, at a height of 10m above flat open country terrain and accounting for altitude effects. This value may be found in the relevant National Annex to the Eurocode.

$$v_b = c_{dir} \times c_{season} \times V_{b,0} \text{ [m/s]}$$

where:

- V_b basic wind velocity, defined as a function of wind direction and time of year at 10m above the ground of terrain category II [m/s]
- $V_{b,0}$ fundamental value of the basic wind velocity [m/s] provides the national annex to the standard
- c_{dir} the directional factor, may be given in the National Annex
- c_{season} the season factor, may be given in the National Annex. For permanent structures the standard recommends that both factors c and c_{season} equal 1.0.

The mean wind velocity should be determined from the basic wind velocity v_b and the height variation of the wind determined from the terrain roughness and orography.

$$v_m(z) = c_r(z) \times c_o(z) \times v_b \text{ [m/s]}$$

- $v_m(z)$ mean wind velocity at height z [m] above the terrain
- $c_r(z)$ roughness factor
- $c_o(z)$ orography factor

Terrain categories and terrain parameters are given in Table 1 below

Table 1. Terrain categories and terrain parameters (according to EN 1991-1-4, Table 4.1)

Terrain category		z_0	z_{min}
		[m]	[m]
0	Sea or coastal area exposed to the open sea	0.003	1
I	Lakes or flat and horizontal area with negligible vegetation and without obstacles	0.01	1
II	Area with low vegetation such as grass and isolated obstacles (trees, buildings) with separations of at least 20 obstacle heights	0.05	2
III	Area with regular cover of vegetation or buildings or with isolated obstacles with separations of maximum 20 obstacle heights (such as villages, suburban terrain, permanent forest)	0.3	5
IV	Area in which at least 15% of the surface is covered with buildings and their average height exceeds 15 m	1.0	10

Note: Terrain categories are illustrated in Annex A of EN 1991-1-4, Section A.1

The roughness factor accounts for the variability of the mean wind velocity at the site of the structure due to the height above ground level and the roughness of the terrain upwind.

$$c_r(z) = k_r \times \ln\left(\frac{z}{z_0}\right) \text{ for } z_{min} \leq z \leq z_{max}$$

$$k_r = 0.19 \times \left(\frac{z_0}{z_{0,II}}\right)^{0.07}$$

$$c_r(z) = c_r(z_{min}) \text{ for } z \leq z_{min}$$

$z_{0,II}$ 0.05m (terrain category II - see Table 2 for other values)

- z_0 the roughness length (see Table 2)
- z_{min} the minimum height defined in Table 2
- z_{max} taken as 200m
- k_r the terrain factor, calculated as follows:

WIND LOADING & DESIGN CALCULATIONS

In accordance with the recommendations of the Eurocode and the relevant National Annexes, the terrain category should be assessed based on the roughness and distance with uniform roughness in a 30° angular sector around the wind direction. If there is a choice between two or more categories, then select the area with the lowest roughness length.

The standard orography factor c_o should be taken as 1. However, in cases where the wind velocities are increased by more than 5% due to orography, then the factor can be determined by following the procedure in Annex A, Section 3 of the Eurocode and in the relevant National Annex.

EN 1991-1-4 also provides guidance for calculation of the influence of neighbouring structures. If the structure is more than twice the average height have of the neighbouring buildings, then the design of those nearby structures may be based on the peak velocity pressure at height z_n ($z_e = z_n$) above ground:

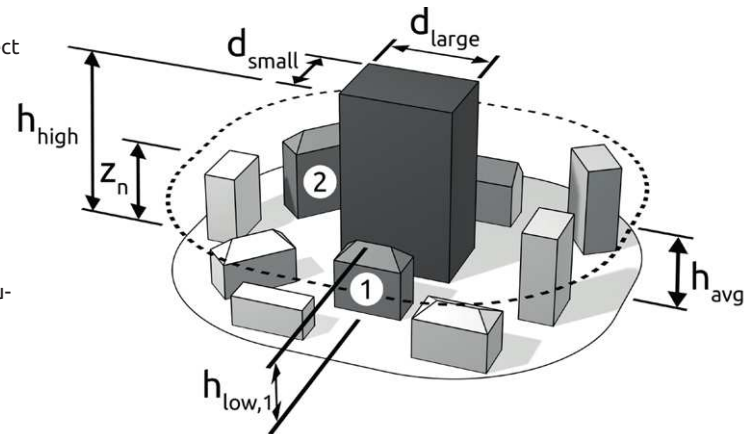

$$z_n = \frac{1}{2}r \quad \text{for } x \leq r$$

$$z_n = \frac{1}{2} \left[r - \left(1 - \frac{2 \times h_{low}}{r} \right) \times (x - r) \right] \quad \text{for } r < x < 2r$$

$$z_n = h_{low} \quad \text{for } x \geq 2r$$

where:

$$r = h_{high} \quad \text{if } h_{high} \leq 2d_{large}$$

$$r = 2d_{large} \quad \text{if } h_{high} > 2d_{large}$$

h_{low} , r , x , d_{small} , d_{large} – are defined in Figure 9

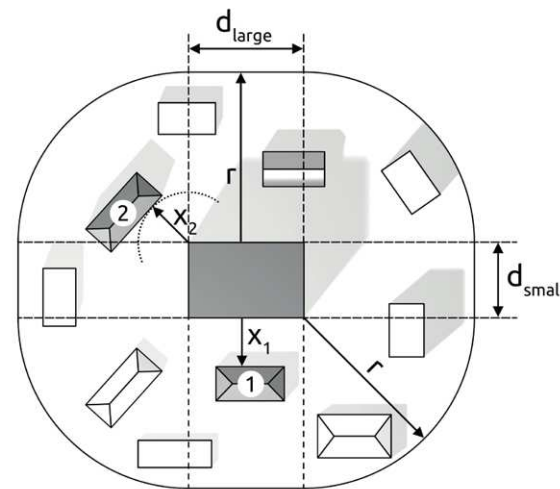

Figure 9. Influence of a high rise building on two neighbouring structures (based on EN 1991-1-4, Figure A.4)

Peak velocity pressure can be determined using:

$$q_p(z) = c_e(z) \times q_b$$

using the exposure factor $c_e(z)$ given in Table 2.

WIND LOADING & DESIGN CALCULATIONS

Table 2. Roughness and exposure factors for each terrain category, with corresponding z_{min} and z_{max}

Terrain category	$c_r(z)$	$c_e(z)$	z_{min}	z_{max}
			[m]	[m]
0	$1,3 \left[\frac{z}{10} \right]^{0,11}$	$3,0 \left[\frac{z}{10} \right]^{0,17}$	1	200
I	$1,2 \left[\frac{z}{10} \right]^{0,13}$	$2,8 \left[\frac{z}{10} \right]^{0,19}$	1	200
II	$1,0 \left[\frac{z}{10} \right]^{0,17}$	$2,3 \left[\frac{z}{10} \right]^{0,24}$	2	300
III	$0,8 \left[\frac{z}{10} \right]^{0,19}$	$1,9 \left[\frac{z}{10} \right]^{0,26}$	5	400
IV	$0,6 \left[\frac{z}{10} \right]^{0,24}$	$1,5 \left[\frac{z}{10} \right]^{0,29}$	10	500

Note: for a height $z > z_{max}$, $c_r(z)$ and $c_e(z)$ should be taken as for z_{max}

During determination of qp calculations between different terrain roughness categories should be taken into account – if a structure with height h is situated closer than 30h from the beginning of a lower terrain category (than the one which directly surrounds the structure), then it should be assumed that structure sits within the lower terrain category.

The reference mean (basic) velocity pressure is calculated as follows:

$$q_b = \frac{1}{2} \times \rho \times v_b^2$$

ρ – air density, dependent on altitude, temperature and barometric pressure

Values for ρ may be taken from the relevant National Annex the recommended value is 1.25 kg/m³.

Determination of the wind loads and structural design should factor in both external and internal wind pressures.

The external pressure coefficients c_{pe} for buildings and parts of buildings depend on the size of the loaded area A, which is the area of the structure, that produces the wind action in the section to be calculated. The external pressure coefficients are given for loaded areas A of 1 m² and 10m² in the tables for the appropriate building configurations as $C_{pe,1}$, for local coefficients, and $C_{pe,10}$, for overall coefficients, respectively.

Values for $C_{pe,1}$ are intended for the design of small elements and fixings with an area per element of 1 m² or less such as cladding elements and roofing elements. Values for $C_{pe,10}$ may be used for the design of the overall load bearing structure of buildings.

The pressure acting on the external surfaces we can be calculated as follows:

$$w_e = q_p(z_e) \times c_{pe}$$

$q_p(z_e)$ – the peak velocity pressure

z_e – the reference height for the external pressure (see Figure 5)

c_{pe} – external pressure coefficient

The wind force f_w acting on the structure may be determined by vectorial summation of the forces $F_{w,e}$, $F_{w,i}$ and F_{fr} calculated from the external and internal pressures, as well as the frictional forces resulting from the friction of the wind parallel to the external surfaces.

For external forces:

$$F_{w,e} = c_s c_d \times \sum_{surfaces} v_e \times A_{ref}$$

$c_s c_d$ - structural factor

w_e - external pressure

A_{ref} - reference area of the individual surface

The structural factor c_{scd} is fully defined in Section 6 of EN 1991-1-4, but the following basic guidelines apply:

- a) For buildings with a height less than 15m the value of c_{scd} may be taken as 1.
- b) For roof elements having a natural frequency greater than 5Hz, the value of c_{scd} may be taken as 1.

Note: One example of b) would be glazing spans shorter than 3m

Finally, by comparing the wind force $F_{w,e}$ (derived from external pressure) for each part of the roof with the load bearing capacities of insulation fixings (stated in this product catalogue), it is possible to assess the suitability of each fixing for the specific roofing application.

WIND LOADING & DESIGN CALCULATIONS

FAÇADES (VERTICAL WALLS)

The reference heights, z_e , for windward walls of rectangular plan buildings (zone D, see Figure 10.1) depend on the aspect ratio h/b and are always the upper heights of the different parts of the walls. They are given in Figure 10 for the following three cases:

- » A building, whose height h is less than b should be considered to be one part.
- » A building, whose height h is greater than b , but less than $2b$, may be considered to be two parts, comprising: a lower part extending upwards from the ground by a height equal to b and an upper part consisting of the remainder.

» A building, whose height h is greater than $2b$ maybe considered to be in multiple parts, comprising: a lower part extending upwards from the ground by a height equal to b ; an upper part extending downwards from the top by a height equal to b and a middle region, between the upper and lower parts, which may be divided into horizontal strips with a height h_{strip} as shown in Figure 10.

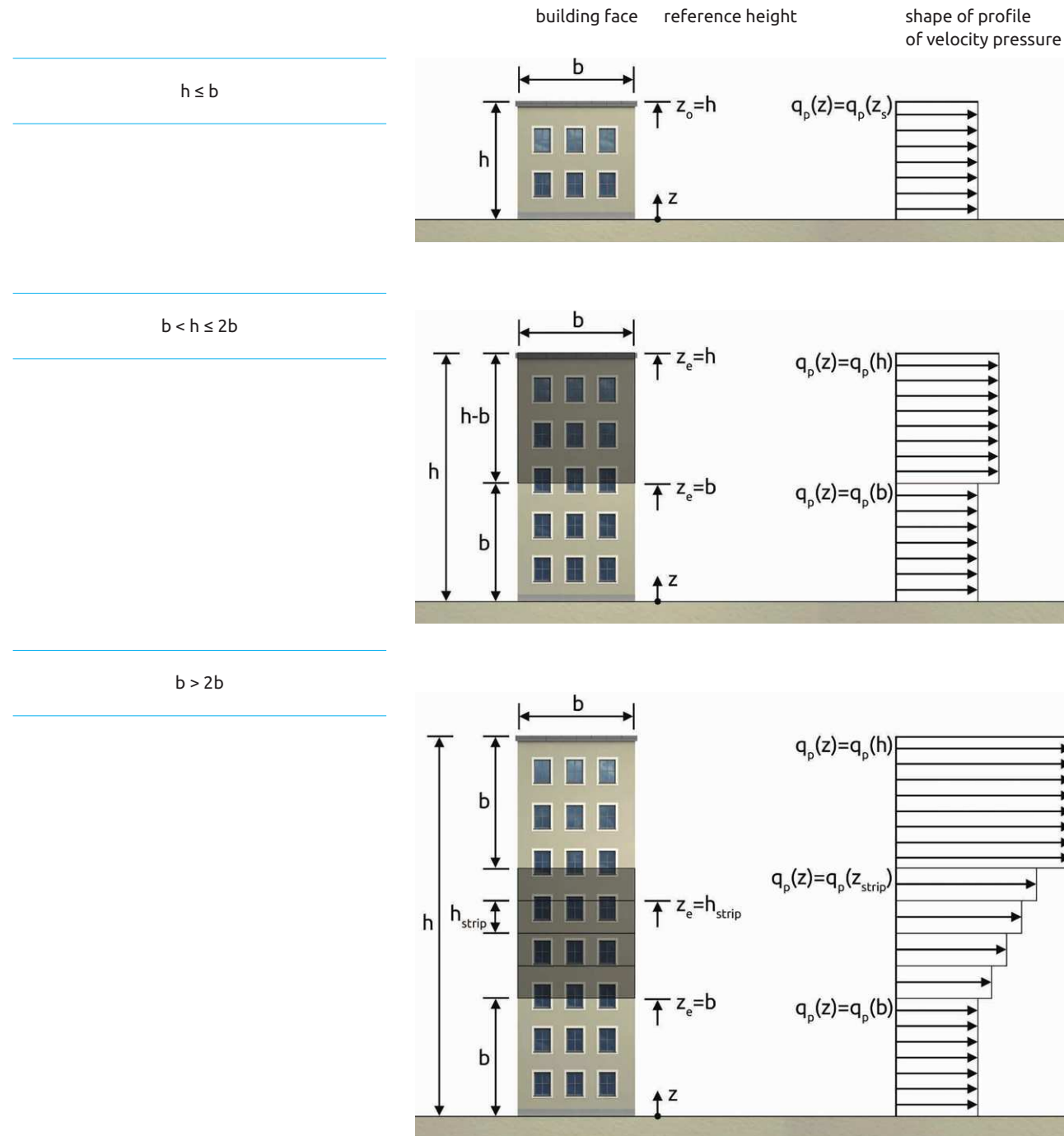

Figure 10 - Reference height, z_e , depending on hand b , and corresponding velocity pressure profile

WIND LOADING & DESIGN CALCULATIONS

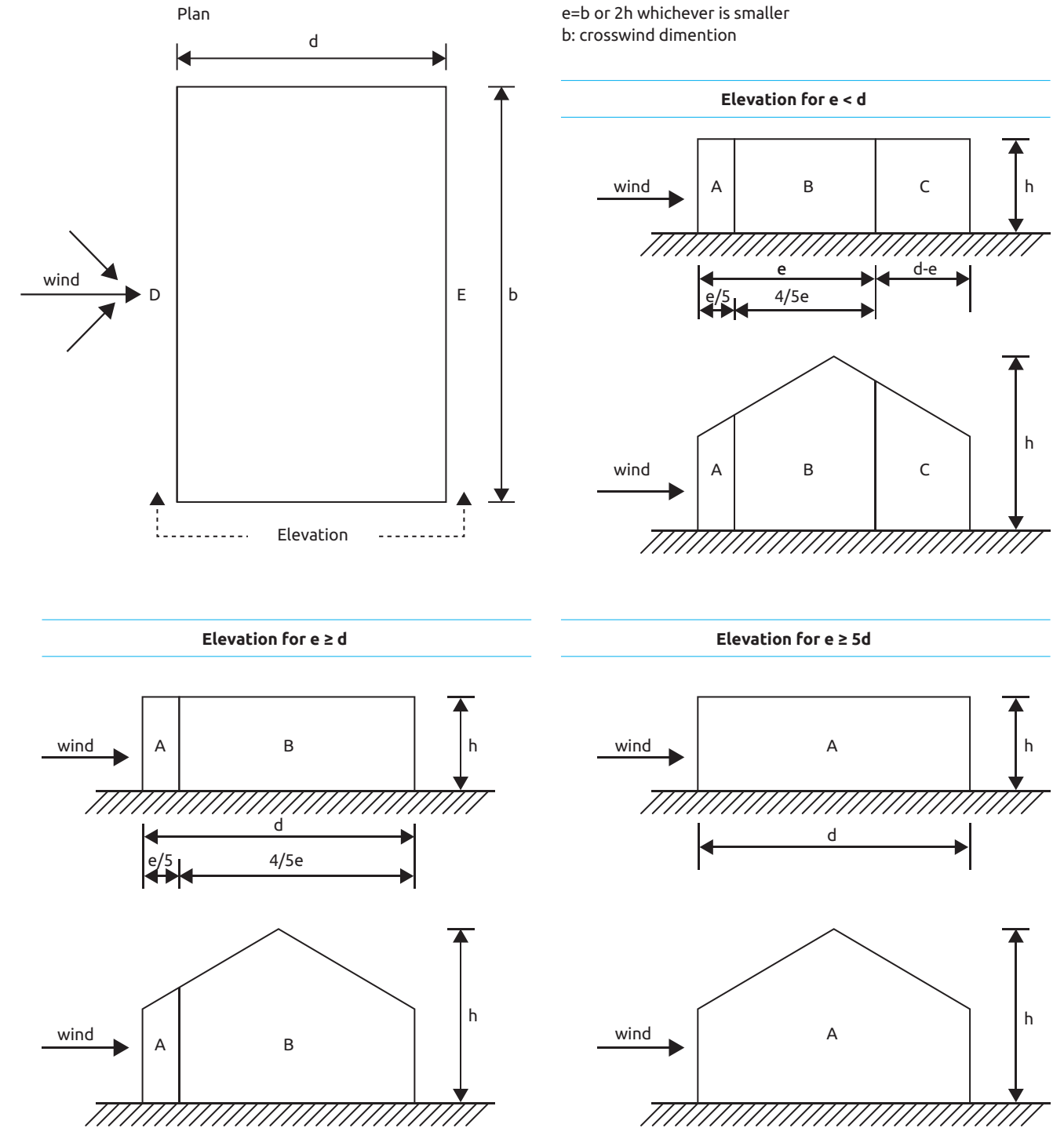

Figure 10.1 - Key for vertical walls

Table. 3 Recommended values of external pressure coefficients for vertical walls of rectangular plan buildings

Zone	A		B		C		D		E	
	$c_{pe,10}$	$c_{pe,1}$	$c_{pe,10}$	$c_{pe,1}$	$c_{pe,10}$	$c_{pe,1}$	$c_{pe,10}$	$c_{pe,1}$	$c_{pe,10}$	$c_{pe,1}$
5	-1,2	-1,4	-0,8	-1,1	-0,5	-	+0,8	+1,0	-0,7	-
1	-1,2	-1,4	-0,8	-1,1	-0,5	-	+0,8	+1,0	-0,5	-
≤ 0,25	-1,2	-1,4	-0,8	-1,1	-0,5	-	+0,7	+1,0	-0,3	-



EasyFix
FAÇADE ETICS
 Module

ROOF MODULE - DESIGN SOFTWARE



FAÇADE ETICS MODULE

Design fixings taking into account wind load, for concrete, masonry, steel and timber substrates.

The module uses a simplified model of entering building shapes.

Makes it possible to exclude the surface area of window openings as well as selected walls in their entirety from the calculations.

The FAÇADE ETICS Module is the calculator which allows for select of proper mechanical façade fixings for masonry and concrete walls with the ETICS systems described in EAD 040083-00-0404 (External thermal insulation composite systems (ETICS) with renderings). The calculation schema is based on the EN 1991-1-4 (Eurocode 1: Actions on structures - Part 1-4: General actions - Wind actions) and EAD 330196-00-0604 (Plastic anchors for fixing of ETICS with rendering).

A very significant option is the one that allows the user to define wind zones and land categories on the basis to maps of many European countries which are enclosed.

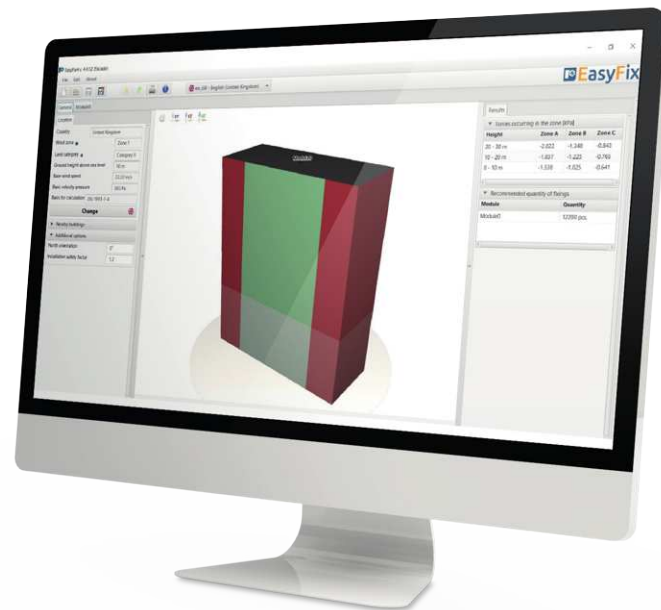

FAÇADE FIXINGS - DESIGN SOFTWARE



WIND CALCULATIONS - MODULES FAÇADE ETICS - MANUAL

General information

- Select a category and module
- Designation of icons and symbols :
- Create** a new project
 - Open** project
 - Save | Save as** project
 - Undo | Redo** changes
 - Generate printout** to pdf file
 - Program information
 - Selecting the program language
 - User Manual

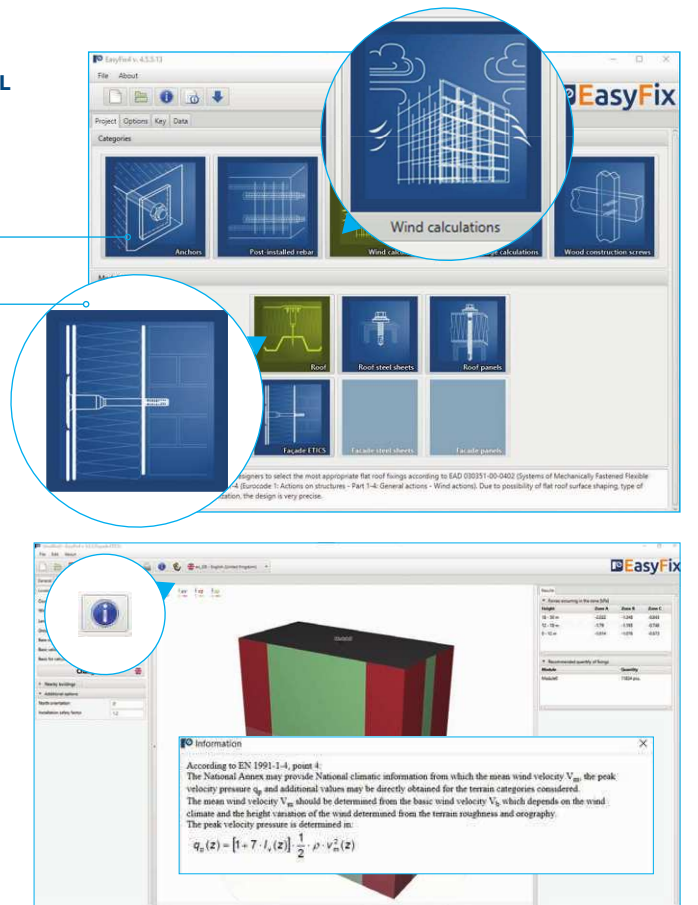

2 Introduction
Basic window of the façade module

The basic window is divided into three areas:

- Input area
- Model view
- Results

1. Input area

- General
- Module
- Location - data concerning the location of an object in the field
- Building - drawing of building shape
- Insulation - type, arrangement and system of insulation

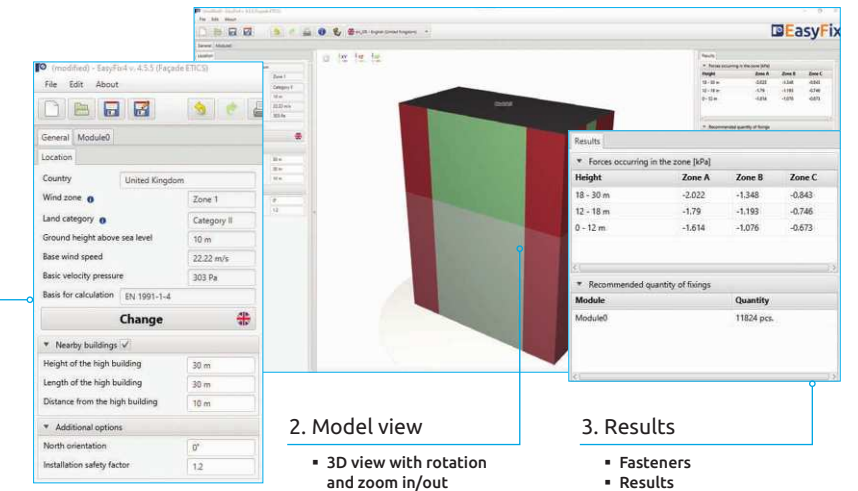

2. Model view

- 3D view with rotation and zoom in/out

3. Results

- Fasteners
- Results

3 General tab - Location
Input area

Location

- enter data on the location of the building
 Clicking on the Change icon opens a window allowing you to select a different location - country

Neighbouring buildings

- a field enabling the influence of neighbouring buildings to be taken into account in the calculation

Additional options

Location relative to north
 Change of safety factor

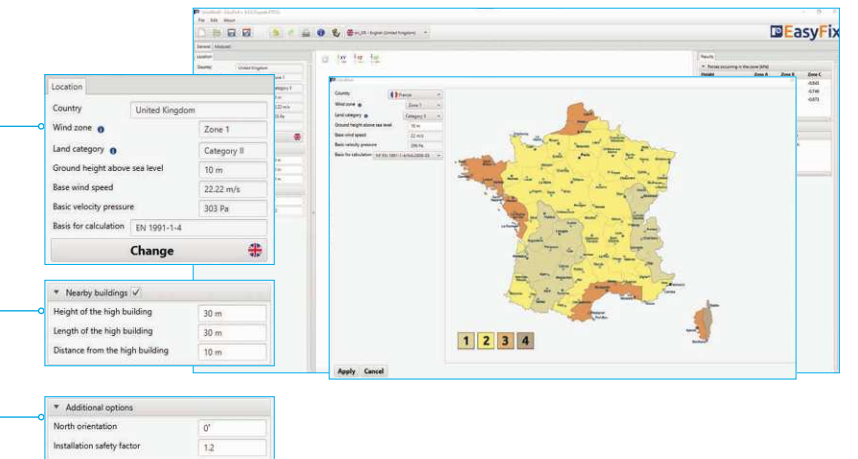

FAÇADE FIXINGS - DESIGN SOFTWARE



WIND CALCULATIONS – MODULES FAÇADE ETICS - MANUAL

4 Module-Building - Isolation tab

Input area

Basic parameters

- allows you to give an individual name to the module and the notes visible on the printout

Substrate

- define Type and type of wall substrate

Shape of building

Clicking the button opens an auxiliary window that allows you to draw the shape of the roof projection

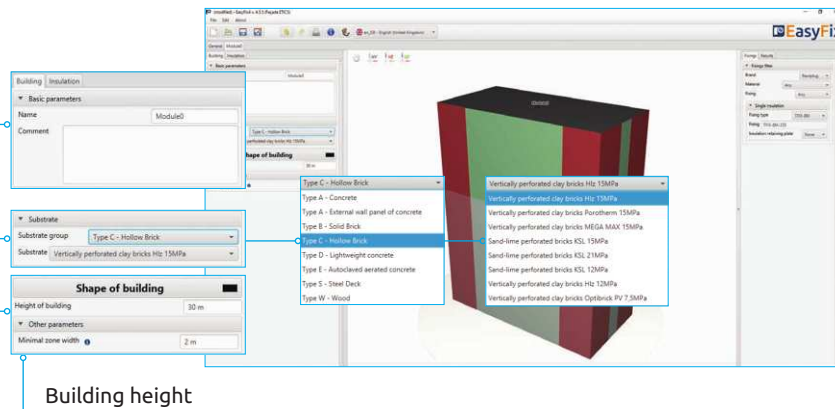

Building height

5 Module 0 tab

Roof shape

Canvas

- Ability to select the direction of the coordinate system

Drawing is possible by clicking on a grid point or entering coordinates in the help window.

The coordinates are entered:
1. the length and angle of the segment separated by <
2. the coordinates of the point

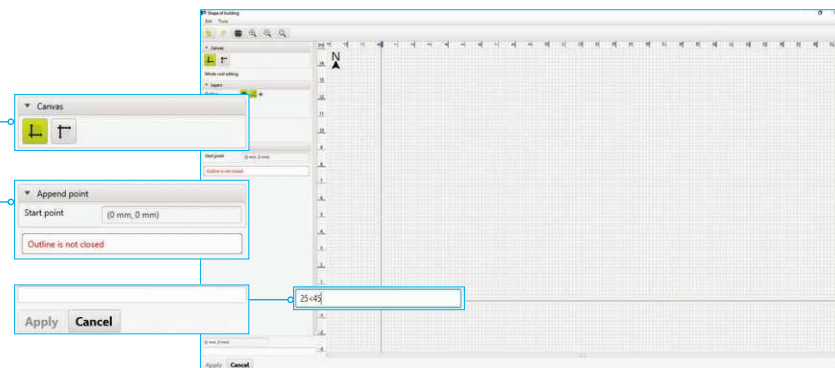

5 Module 0 tab

Roof shape

Layers field

- allows you to enable or disable the view of drawing layers

Segments editing:

- Move point
- Remove point
- Insert point
- Remove segment

Shape editing:

- Move
- Reflection
- Rotation
- Removal

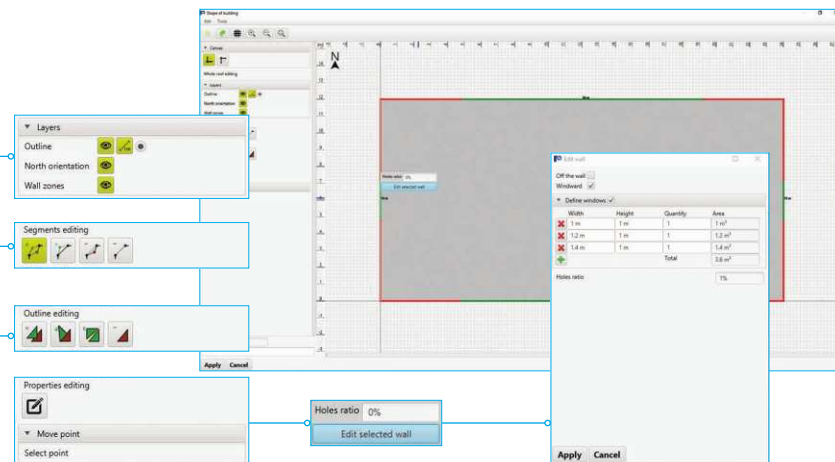

6 Module - Building - Isolation tab

Input area

Insulation layout

- allows to choose an insulation layout between uniform and mixed

Insulation

- allows you to select the type of insulation and ETICS system, select the pressure plate

Pull-trought

force through the insulation - selecting this option allows you to enter the pulling force along with the assembly coefficient

Thickness

fields - enter the thickness of the insulation layers (old + new) and the thickness of the adhesive

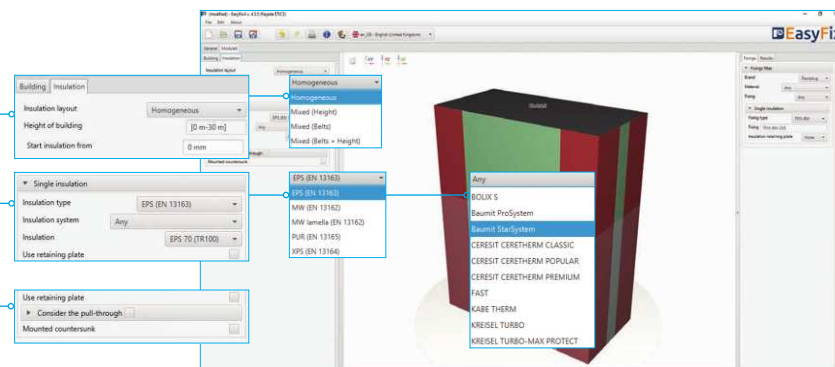

BASICS OF ANCHORING - DESIGN SOFTWARE



WIND CALCULATIONS – MODULES FAÇADE ETICS - MANUAL

7 Model view

3D view

- by clicking on the coordinate system buttons the view can be switched to a 2D plane

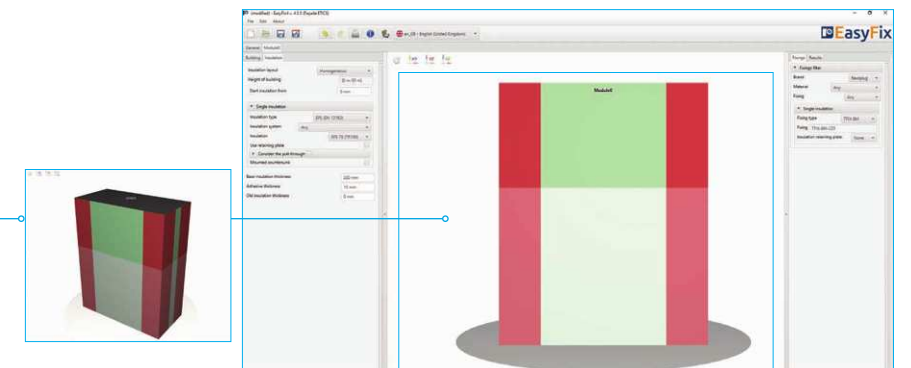

8 Tab Connectors

Results area

Fastener filter

- allows for fastener selection according to defined filters (brand, material, assembly method)

Isolation

- selection of connector within the declared filters

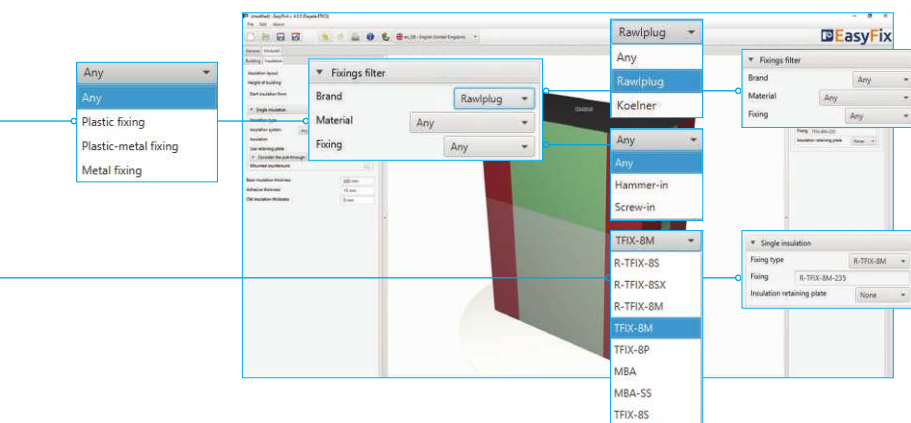

9 Tab Connectors

Results area

Fastener filter

- allows for fastener selection according to defined filters (brand, material, assembly method)

Average number of fasteners per m²

number of fasteners calculated according to EN (minimum quantity included)

Number of connectors

- total number of connectors for the whole building

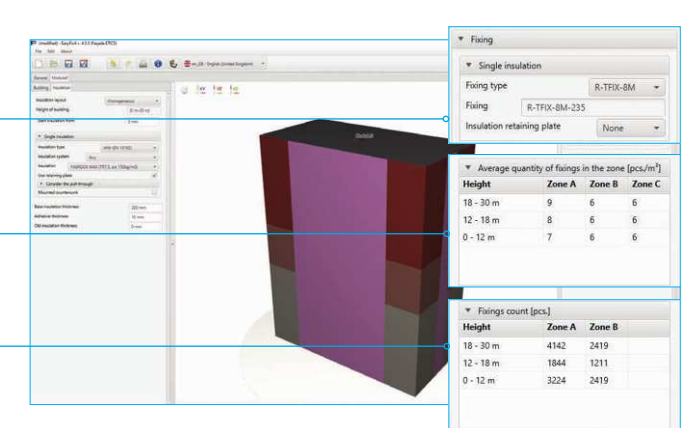

10 Generating

The printout

Print option

Enables the generation of a document in the pdf extension

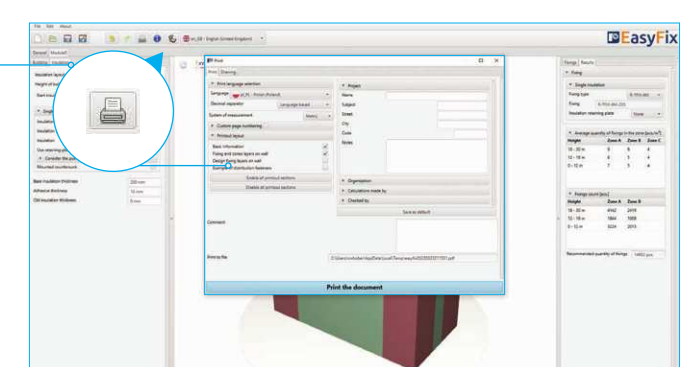

WIND LOADING & DESIGN CALCULATIONS

FLAT ROOF INSULATION

In the case of multi-skin walls and roofs with an impermeable outer skin and an impermeable, more rigid inner skin, the wind force on the outer skin may be calculated from $c_{p,net} = c_{pe}$ (according to Section 7.2.10 of EN 1991-1-4).

The roof structure should be divided into zones as shown in Figure 11, while the pressure coefficient c_{pe} can be taken from Table 4. The reference height z_e for roofs with curved or mansard eaves should be taken as equal to h . The reference height for roofs with parapets is defined in Figure 11.

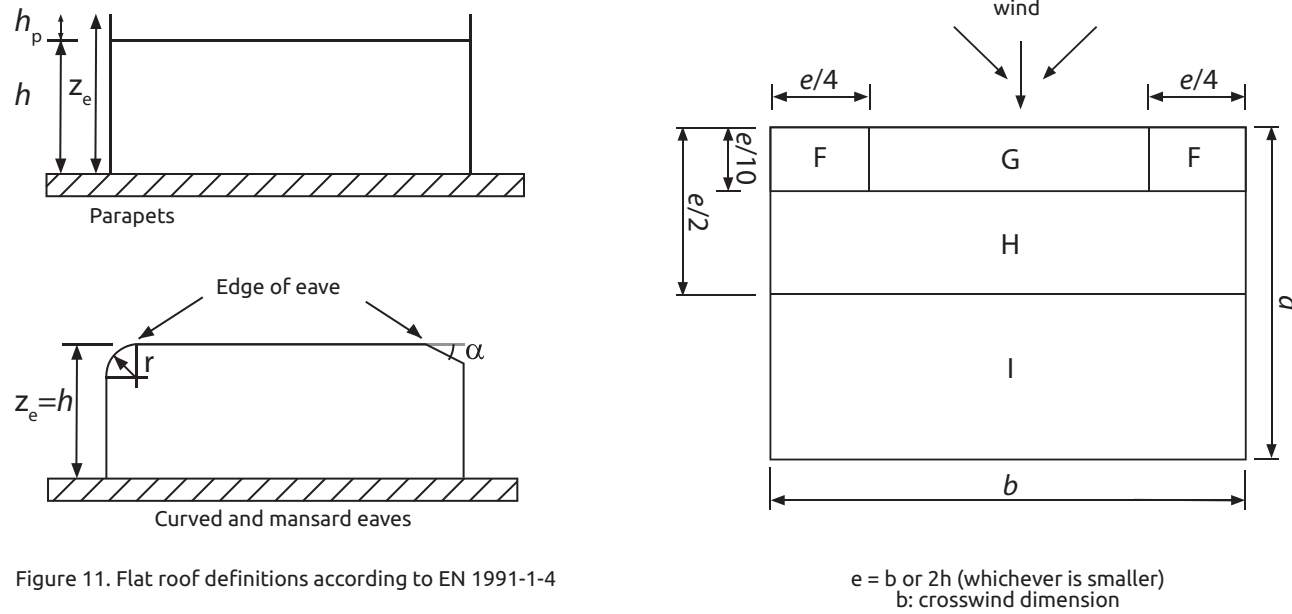

Figure 11. Flat roof definitions according to EN 1991-1-4

All parts of the structure subject to the influence of wind must be considered, unless there is no influence from a specific wind direction.

As a result, a number of wind load zones (generally three or four distinct zones, depending on the size and form of the building) can be defined:

- » exposed zone (F)
- » external edge zone (G)
- » internal edge zone (H)
- » inner zone (I)

These are illustrated in Figure 11.

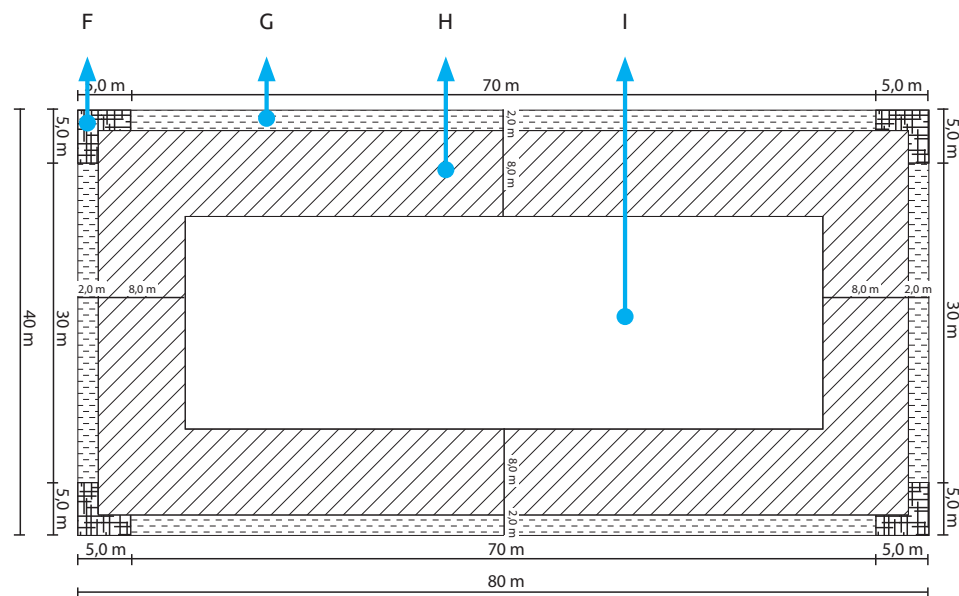

Figure 12. Example of flat roof zone designation

WIND LOADING & DESIGN CALCULATIONS

Table 4. External pressure coefficients for flat roofs (according to Table 7.2 of EN 1991-1-4)

Roof type	Zone								
	F		G		H		I		
	$c_{pe,10}$	$c_{pe,1}$	$c_{pe,10}$	$c_{pe,1}$	$c_{pe,10}$	$c_{pe,1}$	$c_{pe,10}$	$c_{pe,1}$	
Sharp eaves	-1,8	-2,5	-1,2	-2,0	-0,7	-1,2	+0,2	-0,2	
With parapets	$h_p/h = 0,025$	-1,6	-2,2	-1,1	-1,8	-0,7	-1,2	+0,2	-0,2
	$h_p/h = 0,05$	-1,4	-2,0	-0,9	-1,6	-0,7	-1,2	+0,2	-0,2
	$h_p/h = 0,10$	-1,2	-1,8	-0,8	-1,4	-0,7	-1,2	+0,2	-0,2
Curved eaves	$r/h = 0,05$	-1,0	-1,5	-1,2	-1,8	-0,4		+0,2	-0,2
	$r/h = 0,10$	-0,7	-1,2	-0,8	-1,4	-0,3		+0,2	-0,2
	$r/h = 0,20$	-0,5	-0,8	-0,5	-0,8	-0,3		+0,2	-0,2
Mansard eaves	$\alpha = 30^\circ$	-1,0	-1,5	-1,0	-1,5	-0,3		+0,2	-0,2
	$\alpha = 45^\circ$	-1,2	-1,8	-1,3	-1,9	-0,4		+0,2	-0,2
	$\alpha = 60^\circ$	-1,3	-1,9	-1,3	-1,9	-0,5		+0,2	-0,2

- NOTE 1 For roofs with parapets or curved eaves, linear interpolation may be used for intermediate values of h_p/h and r/h
- NOTE 2 For roofs with mansard eaves linear interpolation may also be used between $\alpha = 30^\circ, 45^\circ$ and 60° . For $\alpha > 60^\circ$ linear interpolation between the values for $\alpha = 60^\circ$ and the values for flat roofs with sharp eaves may be used.
- NOTE 3 In Zone I, where positive and negative values are given, both values shall be considered.
- NOTE 4 For the mansard eave itself, the external pressure coefficients are given in EN 1991-1-4, Table 7.4a „External pressure coefficients for duopitch roofs: wind direction 0° “, Zone F and G, depending on the pitch angle of the mansard eave.
- NOTE 5 For the curved eave itself, the external pressure coefficients are given by linear interpolation along the curve, between values on the wall and on the roof.



EasyFix
FLAT ROOF INSULATION Module

FLAT ROOF INSULATION MODULE - DESIGN SOFTWARE



WIND CALCULATIONS – MODULES ROOF - MANUAL

General information

- Select a category and module
- Designation of icons and symbols :
- Create a new project
 - Open project
 - Save | Save as project
 - Undo | Redo changes
 - Generate printout to pdf file
 - Program information
 - Selecting the program language
 - User Manual

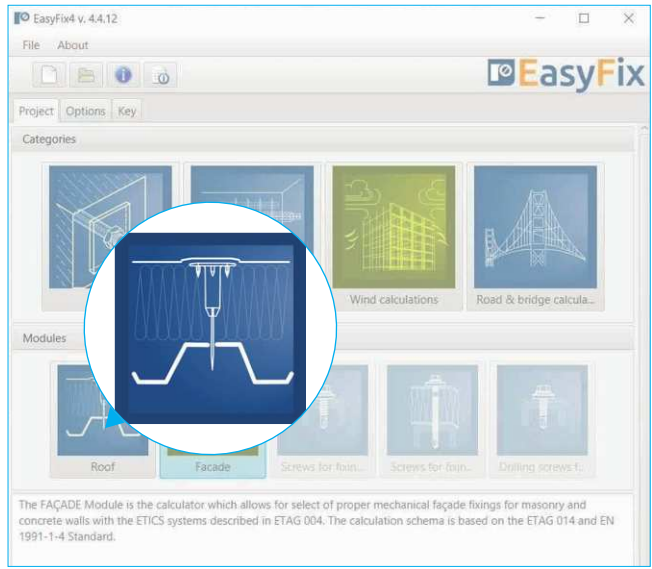
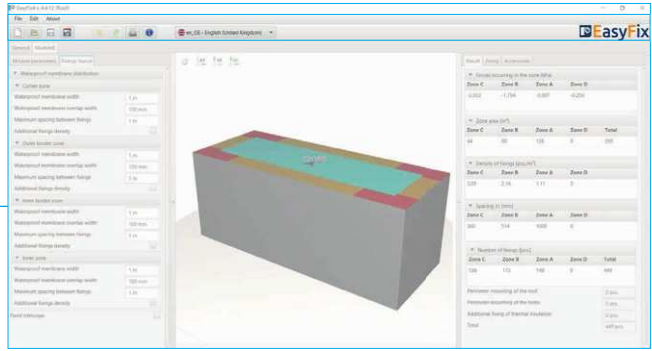

FLAT ROOF INSULATION MODULE - DESIGN SOFTWARE



FLAT ROOF INSULATION MODULE

The FLAT ROOF INSULATION Module allows designers to select the most appropriate flat roof fixings according to EAD 030351-00-0402 (Systems of Mechanically Fastened Flexible Roof Waterproofing Sheets) and EN 1991-1-4 (Eurocode 1: Actions on structures - Part 1-4: General actions - Wind actions). Due to possibility of flat roof surface shaping, type of substrate choosing, fixings length optimization, the design is very precise.

A very significant option is the one that allows the user to define wind zones and land categories on the basis to maps of many European countries which are enclosed.

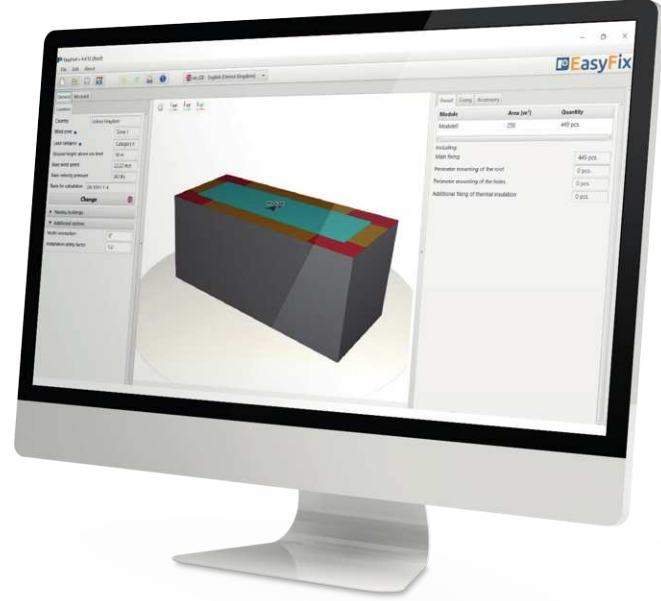

2 Introduction

Basic window of the Façade module

The basic window is divided into three areas:

1. Input area
2. Model view
3. Results

1. Input area
- General
 - Module 0

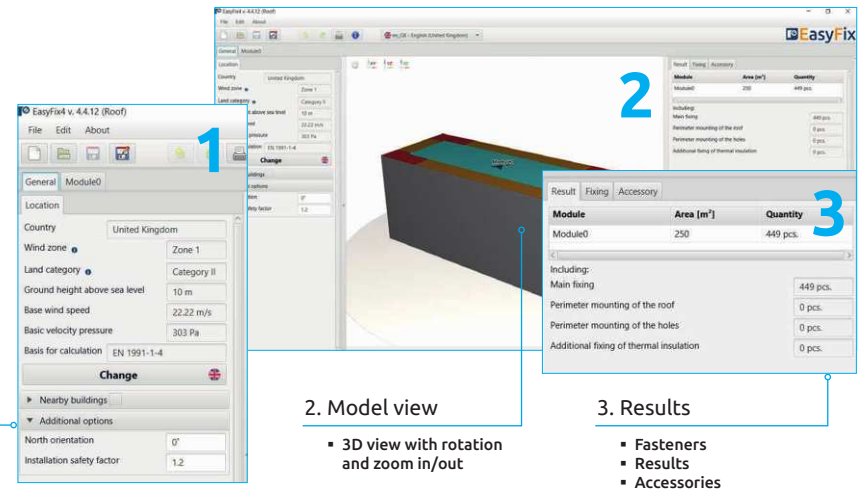

2 General tab - Location

Basic window of the Roof module

Other information: applies to all elements of the scheme

Help icon "i"

Clicking on the icon opens a help window with theory on a particular program function

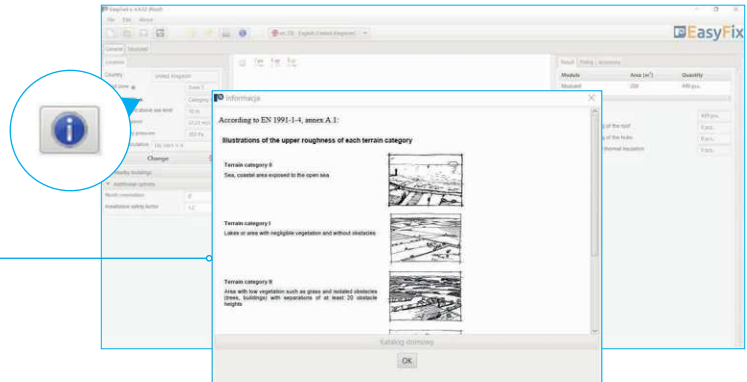

FLAT ROOF INSULATION MODULE - DESIGN SOFTWARE



WIND CALCULATIONS – MODULES ROOF - MANUAL

3 General tab

Input area
Location
 - enter data on the location of the building
 Clicking on the Change icon
 - opens a window allowing you to select a different location - country

A field to allow the introduction of low the introduction of neighbouring buildings affecting the wind forces affecting the object

Options to change the position of an object in relation to the north and to change the installation factor

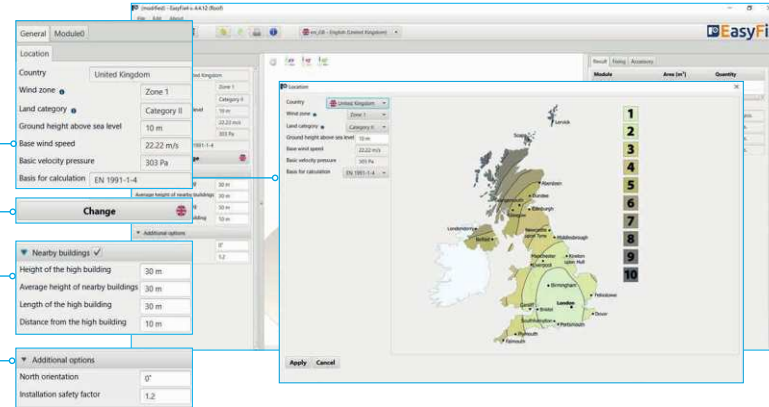

4 Module 0 tab

Data input area
 The Module tab contains two sub tabs:
 1. Module Parameters - shape and construction parameters of the object
 2. System of connectors - waterproofing parameters

Basic parameters
 allows to give own name to the module and comment visible on the printout

Roof termination
 allows for defining the roof edge termination from a drop down list

Clicking on the Roof shape button opens an auxiliary window which allows you to draw the shape of the roof projection

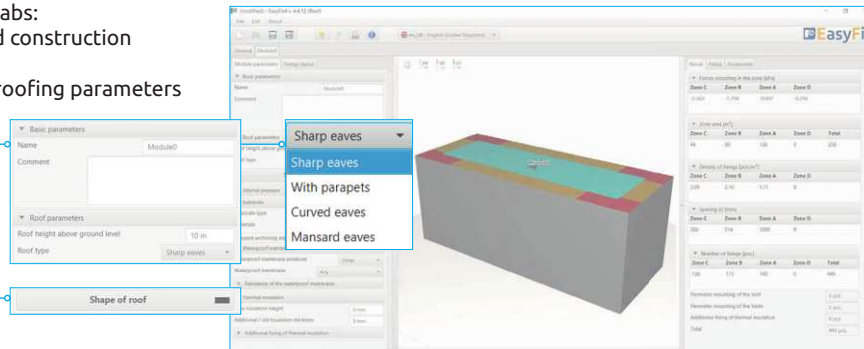

4.1 Module 0 tab

Roof shape

Canvas
 - ability to select the direction of the coordinate system

Pull-trought
 Drawing is possible by clicking on a grid point or entering coordinates in the help window. The coordinates are entered:
 1. the length and angle of the segment separated by <
 2. the coordinates of the point

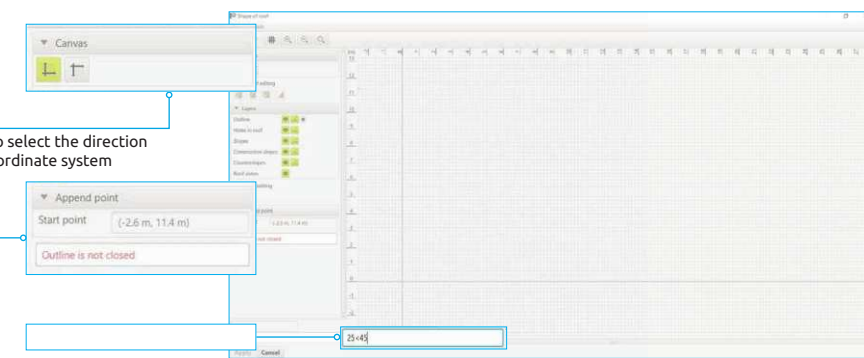

4.1 Module 0 tab

Roof shape

Drawing
 Closing the roof area results in the calculation of wind zones and their visualisation on the drawing

The window for editing the entire shape allows you to:
 - Move
 - Reflection
 - Rotate
 - Deleting

The window for editing the edge of the roof shape allows you to:
 - Moving a point
 - Delete point
 - Adding a point
 - Delete entire side

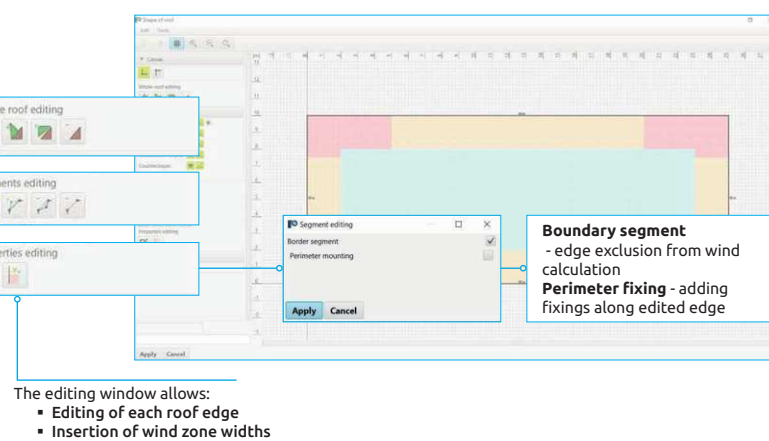

The editing window allows:
 - Editing of each roof edge
 - Insertion of wind zone widths

FLAT ROOF INSULATION MODULE - DESIGN SOFTWARE



WIND CALCULATIONS – MODULES FAÇADE - MANUAL

4 Module 0 tab

Data input area
 The Module tab contains two sub tabs:
 1. Module Parameters - shape and construction parameters of the object
 2. System of connectors - waterproofing parameters

Internal pressure
 - allows consideration according to EN1991-1-4

Substrate
 - allows you to choose from a range of substrates:
 - Sheet metal
 - Concrete
 - Wood

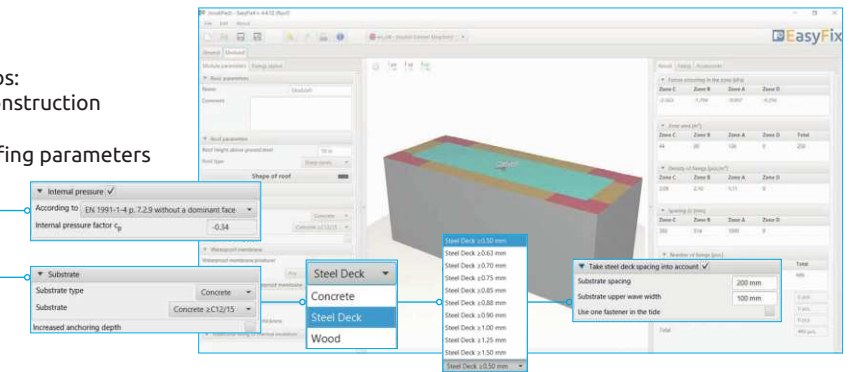

4 Module 0 tab

Data input area
 The Module tab contains two sub tabs:
 1. Module Parameters - shape and construction parameters of the object
 2. System of connectors - waterproofing parameters

Waterproofing
 - allows you to choose the manufacturer of the membrane, and take into account the load capacity specified by the manufacturer

Thermal insulation
 - allows you to enter the designed base thickness of insulation and the thickness of existing layers of old hydro and thermal insulation on the roof

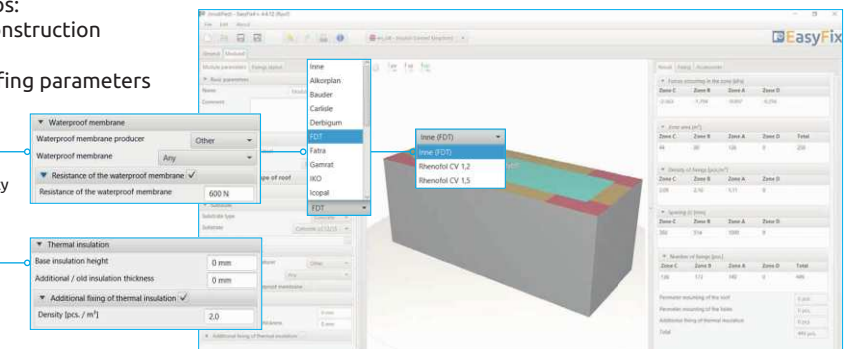

4 Module 0 tab

Data input area
 The Module tab contains two sub tabs:
 1. Module Parameters - shape and construction parameters of the object
 2. System of connectors - waterproofing parameters

Layout of fasteners
Waterproofing layout
 - allows the width and overlap of the waterproofing to be defined along with the maximum fastener spacing in each wind zone separately. In addition, it is possible to allow fixing on the slope beyond the overlap.

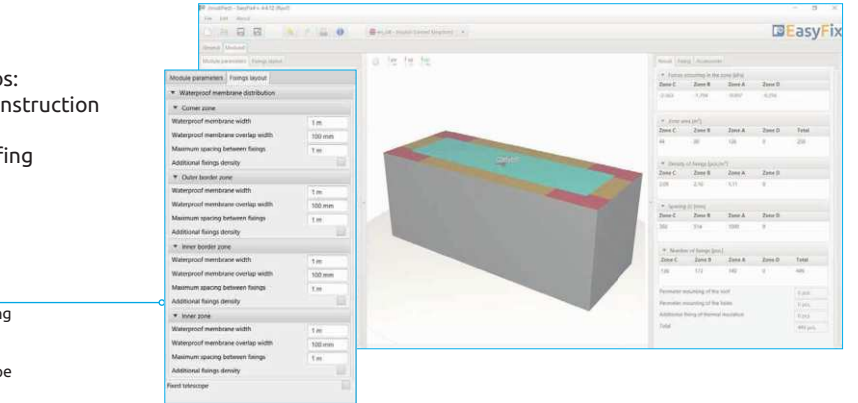

5 Model view

3D view
 - by clicking on the coordinate system buttons the view can be switched to a 2D plane

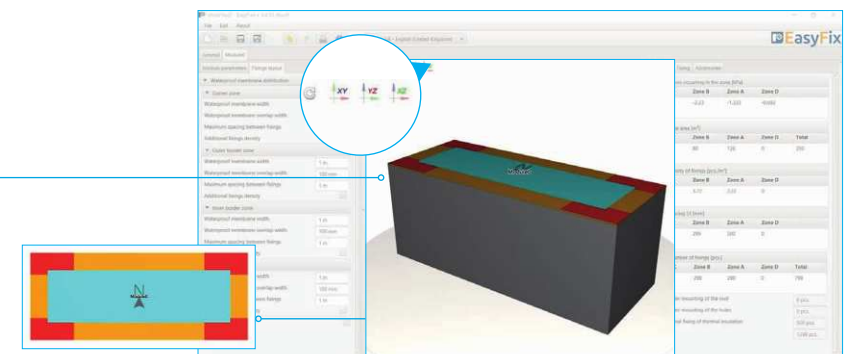

FLAT ROOF INSULATION MODULE - DESIGN SOFTWARE



WIND CALCULATIONS – MODULES ROOF - MANUAL

6 Tab Connectors Results area

Results tab
 - contains calculated Values of wind forces in the zones
 Area of wind zones
 Number of connectors per m2 in the zones
 Spacing between fasteners
 Total number of connectors in each zone and on the whole roof
 Information about additional fasteners

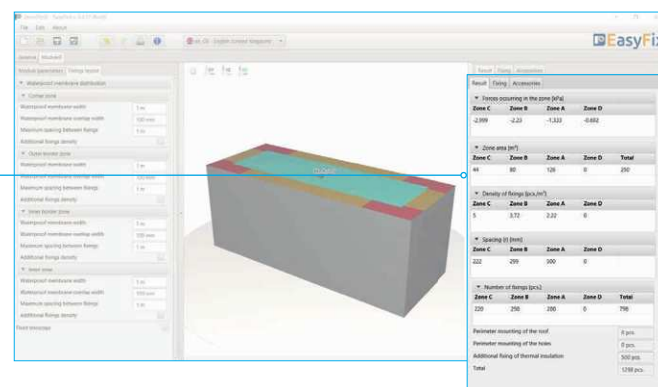

6 Tab Connectors Results area

Fastener's tab
 - allows for filtering and optimal selection of the fastener

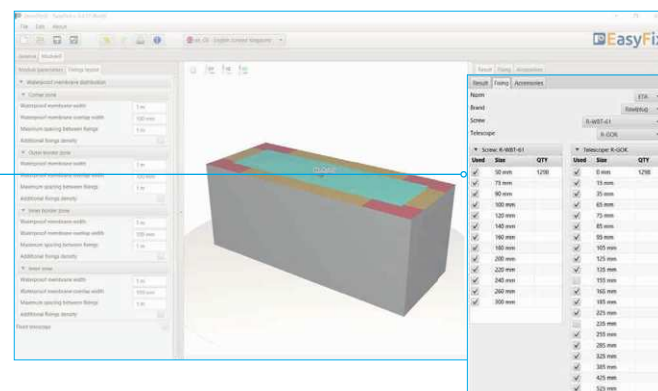

6 Tab Connectors Accessories area

Accessories tab
 - suggests the type and quantity of accessories needed to complete the calculated roof

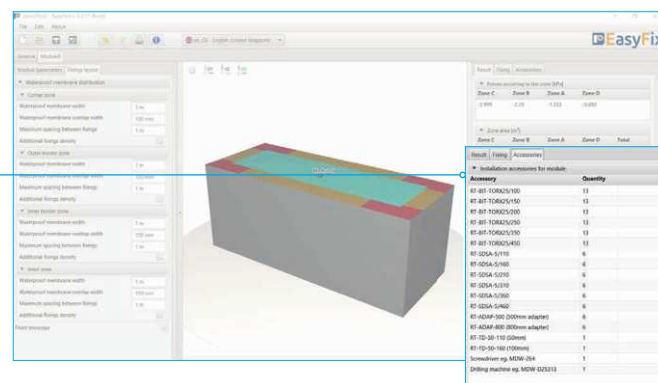

7 Generation of Printout

In the printout panel, we can set regional options, i.e. language, decimal separator and unit system. The printout in pdf format contains all data necessary for projects and product installation.

Print option
 Enables the generation of a document in the pdf extension

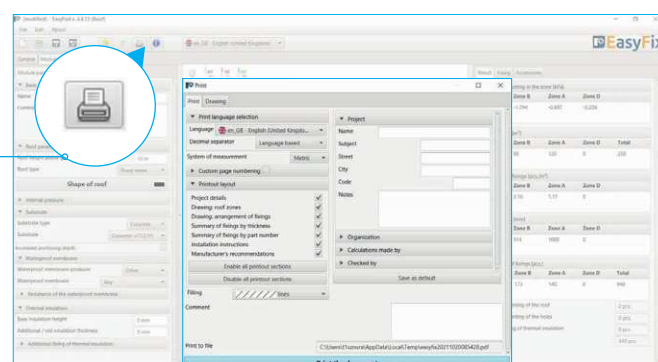

TESTY OBCIĄŻEŃ DYNAMICZNYCH ŁĄCZNIKÓW DO DACHÓW PŁASKICH

BADANIA WIATROWE

Podstawowym celem mechanicznego mocowania pokryć dachowych jest utrzymanie w okresie użytkowania zewnętrznej membrany wodoszczelnej w stabilnym położeniu na dachu uwzględniając zmienne warunki atmosferyczne. Firma RAWPLUG dbając o jakość produkowanych łączników mechanicznych do mocowania warstw izolacji na dachach płaskich przeprowadza badania wraz z producentami membran w renomowanych ośrodkach badawczych, które mają na celu określenie rzeczywistych wartości sił oddziaływujących na dachu. Do praktycznej weryfikacji zachowania się całego układu materiałów przy mechanicznym ich mocowaniu służą testy obciążeń dynamicznych zwane badaniem w skali naturalnej, które są opisane w wytycznych do europejskich aprobat technicznych ETAG006. Testy obciążeń dynamicznych pozwalają na precyzyjne określenie wartości obciążeń, jakim może być poddany dany układ zabudowy na dachu. W czasie takiej próby następuje odzwierciedlenie rzeczywistych obciążeń występujących na dachu w okresie jego użytkowania. Badanie umożliwia wykrycie najsłabszych punktów, elementów układu oraz miejsc, gdzie w pierwszej kolejności nastąpi rozszczelnienie poszycia dachowego.

Testy obciążeń dynamicznych przeprowadza się na specjalnych symulatorach, gdzie badaną próbkę układu dachowego poddaje się wymuszonemu obciążeniu. Pomiaru dokonuje komputerowe oprzyrządowanie z czujnikami rejestrującymi dane do odczytu, archiwizacji i analizy wyników. Badaniu poddawany jest zestaw materiałów: membrana hydroizolacyjna, izolacja termiczna, podłoże: blacha, beton, drewno wraz z odpowiednim dla niego łącznikiem. Opis szczegółów związanych z wymiarami próbek, minimalnymi grubościami poszczególnych materiałów, liczbą i rozmieszczeniem łączników oraz przebiegiem testu i określeniu uzyskanych wyników jest zawarty w ETAG006 w rozdziale 5.1.4.1 Badanie odrywania przez wiatr. Poniższa tabela zawiera zestawienie liczby powtórzeń obciążeń częściowych wraz z wartością siły obciążeniowej dla pojedynczego cyklu. Należy zwrócić uwagę na fakt, że maksymalna siła obciążająca w danym cyklu występuje tylko dla jednego, pojedynczego obciążenia częściowego.

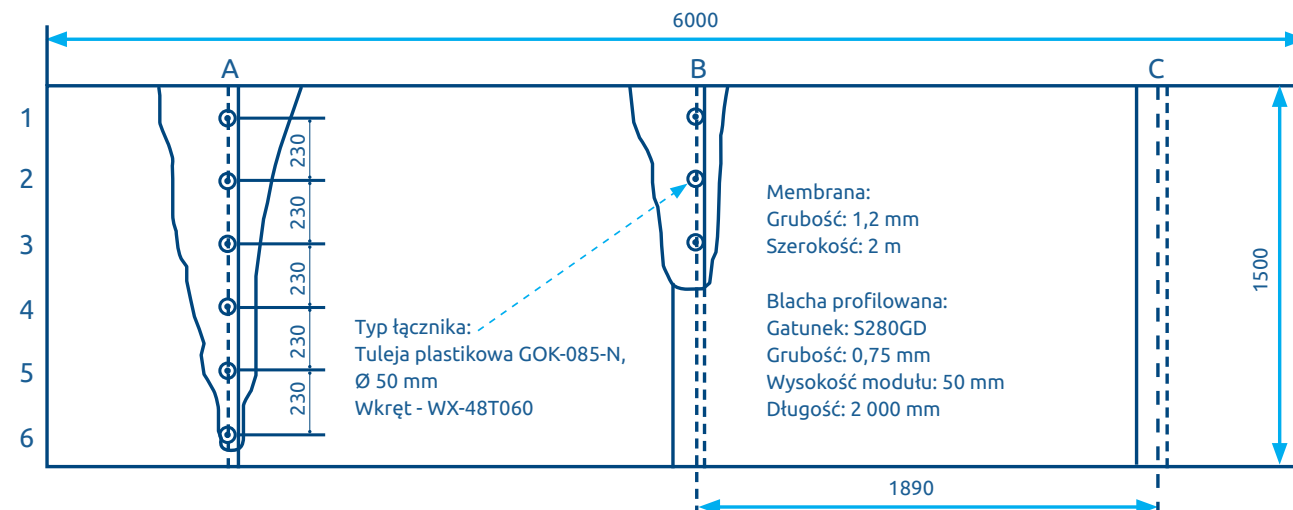

Liczba powtórzeń obciążeń oraz wartości sił częściowych w przypadku pojedynczego obciążenia

Liczba powtórzeń obciążeń częściowych	Wartość siły częściowej, obciążającej
500	40 % siły maksymalnej w danym cyklu
200	60 % siły maksymalnej w danym cyklu
5	80 % siły maksymalnej w danym cyklu
2	90 % siły maksymalnej w danym cyklu
1	100 % siły maksymalnej w danym cyklu
2	90 % siły maksymalnej w danym cyklu
5	80 % siły maksymalnej w danym cyklu
200	60 % siły maksymalnej w danym cyklu
500	40 % siły maksymalnej w danym cyklu

Zaleca się, aby pierwsze cztery cykle powtarzane były przy tej samej wartości siły maksymalnej 300 N. Potem każdy kolejny cykl odbywa się przy wartości maksymalnej siły obciążeniowej wyższej

o 100 N od poprzedniej, czyli maksymalne siły obciążające dla kolejnych cykli wynoszą: 400 N, 500 N, 600 N.



Facade Insulation Fixings

R-TFIX-8S Universal facade fixings	320
R-TFIX-8S-X Universal facade fixings	323
R-TFIX-8M Facade fixings with metal nail	326
TFIX-8P Facade fixings with plastic pin	329
MBA/MBA-SS Facade fixings	331
KCX Tube insulation washer	333
R-KC Insulation washer	336
R-DB Ceiling screw-in solution with washer	338
R-KWL Insulation retaining plate	340
R-KWX Insulation retaining plate with perforator	341

OVERVIEW OF OUR RANGE LIGHTWEIGHT FIXINGS SELECTOR



ETICS FIXINGS

FAÇADE INSULATION FIXINGS		R-TFIX-8S	R-TFIX-8S-X	R-TFIX-8M
INSULATION MATERIAL	EXTRUDED OR EXPANDED POLYSTYRENE	✓	✓	✓
	MINERAL WOOL	✓	✓	✓
	LAMELLA WOOL + HOLDING FLANGE			
	CORK BOARDS, WOOD FIBREBOARDS, LIGHTWEIGHT RECYCLED PANELS	✓	✓	✓
SUBSTRATES	CONCRETE	A ✓ 1.5 kN	✓ 1.5 kN	✓ 1.2kN
	SOLID BRICK, CALCIUMSILICATE BRICK, CONCRETE BLOCKS, STONE	B ✓ 1.5 kN	✓ 1.5 kN	✓ 1.2kN
	HOLLOW BRICK, CHEQUER BRICK, CERAMIC HOLLOW BRICKS	C ✓ 0.9 kN	✓ 0.9 kN	✓ 0.5-1.1 kN
	LIGHTWEIGHT CONCRETE BLOCKS, E.G. LECA CONCRETE	D ✓ 0.6 kN	✓ 0.6 kN	✓ 0.5 kN
	AUTOCLAVED CELLULAR (GAS) CONCRETE	E ✓ 1.2 kN	✓ 1.2 kN	✓ 1.0 kN
	TIMBER, WOOD-BASED BOARDS	-	-	-
	TRAPEZOIDAL SHEET	-	-	-
APPROVALS AND REPORTS		ETA 17/0161	ETA 17/0161	ETA 17/0592
AVAILABLE LENGHTS [MM]		115, 135, 155, 175, 195, 215, 235, 255, 275, 295, 335, 355, 375, 395, 415, 435, 455	115, 135, 155, 175, 195, 215, 235, 255, 275, 295, 335, 355, 375, 395, 415, 435, 455	95, 115, 135, 155, 175, 195, 215, 235, 275, 295
THERMAL INSULATION THICKNESSES RANGE [MM]		60-420	60-420	60 - 260
DRILL DIAMETER [MM]		8	8	8
ANCHORAGE DEPTH (MM)		25 (65)	25 (65)	25 (65)
INSTALLATION TYPE		screw-in	screw-in	hammer set
ADDITIONAL INFORMATION		The best fastener for eVery fixing. 100% correct anchoring in all conditions. The best parameters, the most Versatile of professional fixings.		The best hammered-in fixing. Very good parameters with the simplest installation.

OVERVIEW OF OUR RANGE LIGHTWEIGHT FIXINGS SELECTOR



ETICS FIXINGS

INSULATION FIXINGS

TFIX 8P	MBA	R-KC	KCX	R-DB
✓	✓	✓	✓	-
✓	✓	✓	✓	-
				-
✓	✓	-	-	
✓ 0.5 kN	✓ 0.8 kN	-	✓ 1.5 kN	✓ 0.5 kN
✓ 0.5 kN	✓ 0.6 kN	-	-	-
✓ 0.3 kN	-	-	-	-
✓ 0.3 kN	-	-	-	-
✓ 0.5 kN	✓ 0.8 kN	-	-	-
-	-	✓ 0.91kN	✓ 1.5 kN	-
-	-	✓ 0.81 kN	✓ 1.5 kN	-
ETA-13/0845	KOT-2018/0721	KOT-2017-0345	AT-15-9280/2014	Zulassung: Z-21.8-2077
95, 115, 135, 155, 175, 195, 215	MBA: 80, 110, 140, 170, 200, 240, 300, MBA-SS: 90, 110, 140, 170, 200, 250, 300	UC: 50, 60, 70, 80, 90, 100, 110, 120, 130, 140, 150, 160, 180, 200WB: 80, 100, 120, 140, 160, 170, 180, 200, 220	UC: 50, 60, 70, 80, 90, 100, 110, 120, 130, 140, 150, 160, 180, 200 WB: 80, 100, 120, 140, 160, 170, 180, 200, 220	50, 75, 90, 100, 120, 140, 160, 180, 200, 220, 240, 260, 300
50-180	50 - 160	40 -200	40-350	50-300
8	8	-	-	5.0
25 (65)	50	30	30	30
hammer set	hammer set	screw-in	screw-in	screw-in
The economical fixing for bonded ETICS applications.	Non-flammable fixings for ETICS-requiring installations.	The best choice for timber, sheathing board and trapezoidal sheet.	The best choice for timber, sheathing board and trapezoidal sheet.	The best choice for timber, sheathing board and trapezoidal sheet.

R-TFIX-8S UNIVERSAL FACADE FIXINGS

Versatile screw-in facade fixing with high performance in all base materials recommended for ETICS



FEATURES AND BENEFITS

- The shortest embedment depth at the maximum strength parameters
- Quick and easy installation in all substrates (categories A,B,C,D,E)
- Unique sleeve compression zone for precision installations.
- The long plastic overmoulding on the R-TFIX-8S screw minimises thermal bridging (value 0,001-0,002W/K), contributing to energy-saving benefits
- Plate stiffness (value 0.6 kN/mm) ensures smooth elevation surface and stable insulation system.
- Unique design allows for high load-bearing capacities. This reduces the quantity of fixings required per square metre of insulation
- Pre-assembled screw saves time and labour.

APPLICATIONS

- External Thermal Insulation Composite Systems (ETICS)
- Polystyrene (EPS) boards
- Mineral wool (MW) boards
- Polyurethane (PU) boards
- Cork boards
- Light wool building boards

BASE MATERIALS

- Approved for use in:
- Concrete C12/15-C50/60 (Use category A)
 - External wall panel of concrete C 16/20 - C50/60 (Use category A)
 - Solid Brick (Use category B)
 - Solid Sand-lime Brick (Use category B)
 - Vertically-perforated clay block (Use category C)
 - Reinforced components of lightweight aggregate concrete (Use category D)
 - Aerated Concrete Block (Use category E)

INSTALLATION GUIDE

R-TFIX - TOOL - RED

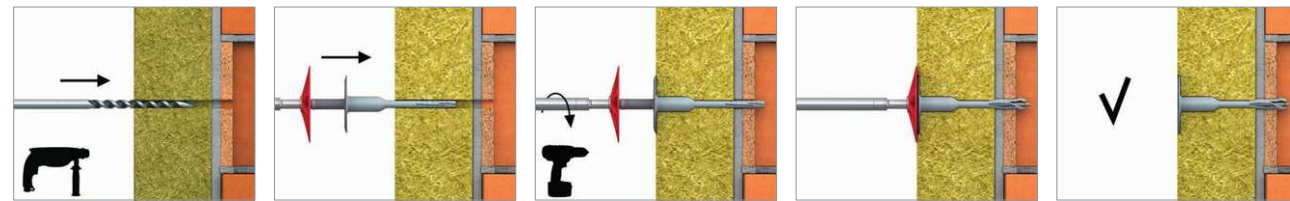

R-TFIX - TOOL - GREEN + R-KWX

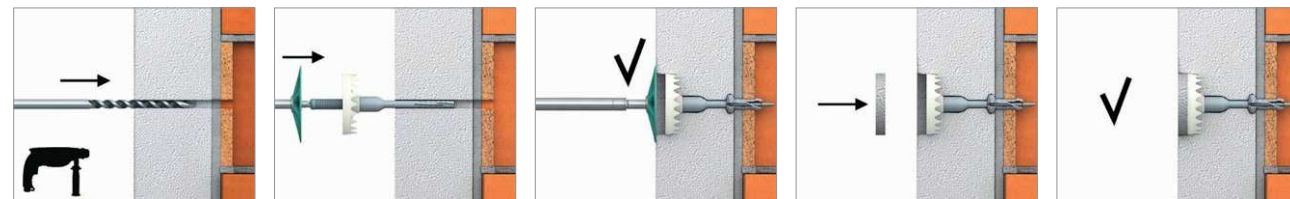

1. Drill a hole of required diameter and depth
2. Drilling depth of min 35mm in A,B,C,D materials and 75mm in Aerated Concrete Block.
3. Clean drilled hole 3 times.
4. Insert driver bit into recess in head moulding of R-TFIX-8S screw.
5. Insert the fixing into the drilled hole.
6. After inserting the fixing in the hole, the plate should be pressed against the thermal insulation surface.
7. Embedment depth of min 25mm in A,B,C,D materials and 65mm in Aerated Concrete Block.
8. Apply steady axial pressure, ensuring the disc of the setting tool is kept perpendicular to the fixing axis.
9. Steadily drive in the screw with high revs until fixing is secure (when disc touches insulation surface).

R-TFIX-8S UNIVERSAL FACADE FIXINGS

PRODUCT INFORMATION

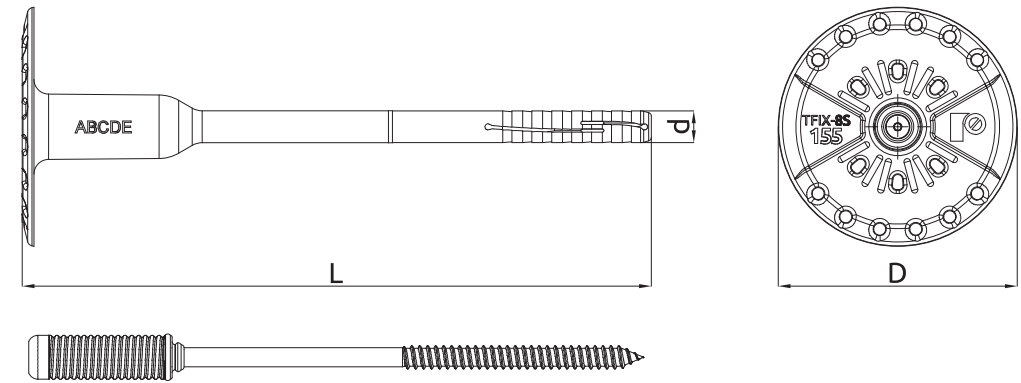

Size	Product Code	Fixing			Fixture	
		Diameter	Plate diameter	Length	Recommended thickness	
		d [mm]	D [mm]	L [mm]	t _{fix} A, B, C, D [mm]	t _{fix} E [mm]
Ø08	R-TFIX-8S-115	8	60	115	80	40
	R-TFIX-8S-135	8	60	135	100	60
	R-TFIX-8S-155	8	60	155	120	80
	R-TFIX-8S-175	8	60	175	140	100
	R-TFIX-8S-195	8	60	195	160	120
	R-TFIX-8S-215	8	60	215	180	140
	R-TFIX-8S-235	8	60	235	200	160
	R-TFIX-8S-255	8	60	255	220	180
	R-TFIX-8S-275	8	60	275	240	200
	R-TFIX-8S-295	8	60	295	260	220
	R-TFIX-8S-315	8	60	315	280	240
	R-TFIX-8S-335	8	60	335	300	260
	R-TFIX-8S-355	8	60	355	320	280
	R-TFIX-8S-375	8	60	375	340	300
	R-TFIX-8S-395	8	60	395	360	320
R-TFIX-8S-415	8	60	415	380	340	
R-TFIX-8S-435	8	60	435	400	360	
R-TFIX-8S-455	8	60	455	420	380	

INSTALLATION DATA

Size			A, B, C, D	A - external panel	E
Fixing diameter	d	[mm]	8	8	8
Hole diameter in substrate	d ₀	[mm]	8	8	8
Min. installation depth	h _{nom}	[mm]	25	25	65
Min. hole depth in substrate	h ₀	[mm]	35	35	75
Min. hole depth in substrate - countersunk mounting	h ₀	[mm]	45	45	85
Min. substrate thickness	h _{min}	[mm]	100	40	100
Min. spacing	s _{min}	[mm]	100	100	100
Min. edge distance	c _{min}	[mm]	100	100	100

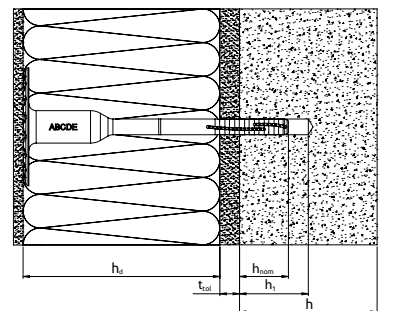

R-TFIX-8S UNIVERSAL FACADE FIXINGS

BASIC PERFORMANCE DATA

Performance data for single anchor without influence of edge distance and spacing

Substrate		Concrete C12/15	Concrete min. C16/20	External wall panel of concrete	Solid clay brick min 20MPa (eg Mz20/2.0)	Sand-lime brick min. 30MPa	Hollow brick 15 MPa	Prefabricated reinforced components of lightweight aggregate concrete 4MPa	Autoclaved aerated concrete AAC 4MPa
Effective embedment depth h_{ef}	[mm]	25	25	25	25	25	25	25	65
MEAN ULTIMATE LOAD N_{Rm}									
R-TFIX-8S	[kN]	1.64	2.03	2.03	1.78	1.94	1.13	1.12	1.56
CHARACTERISTIC LOAD N_{Rk}									
R-TFIX-8S	[kN]	1.20	1.50	1.50	1.50	1.50	0.90	0.90	1.20
DESIGN LOAD N_{Rd}									
R-TFIX-8S	[kN]	0.60	0.75	0.75	0.75	0.75	0.45	0.45	0.60
RECOMMENDED LOAD N_{Rrc}									
R-TFIX-8S	[kN]	0.43	0.54	0.54	0.54	0.54	0.32	0.32	0.43

Fixing type		R-TFIX-8S
Plate resistance	[kN]	2.04
Plate stiffness	[kN/mm]	0.6
Point thermal transmittance	[W/K]	0,001 - 0,002

ASSOCIATED PRODUCTS



RT-SDSA
Drill bits Aggressor SDS plus



RT-SDSB
Drill bits Brickdrill SDS plus



RT-SDSR
Drill bits Rebardrill SDS plus



R-TFIX-TOOL-RED
Setting tool

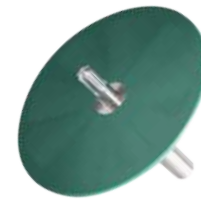

R-TFIX-TOOL-GREEN
Setting tool

R-TFIX-8S-X UNIVERSAL FACADE FIXINGS

Versatile screw-in facade fixing with high performance in all base materials recommended for ETICS



FEATURES AND BENEFITS

- Quick and easy installation in all substrates (categories A,B,C,D,E)
- Unique sleeve compression zone for precision installations.
- Installation with post-installed insulation cap R-TFIX-CAP reduces heat transmission and results in a homogenous insulation surface
- Plate stiffness (value 0.6 kN/mm) ensures smooth elevation surface and stable insulation system.
- Unique design allows for high load-bearing capacities. This reduces the quantity of fixings required per square metre of insulation
- The shortest embedment depth at the maximum strength parameters
- Countersunk installation possible with use of R-TFIX-TOOL-CSM or additional R-KWX-063 plate with post-installed R-TFIX-CAP63 insulation cap and system bit R-TFIX-TOOL-BLACK
- Installation flush with the surface possible with use of R-TFIX-TOOL-BLACK system bit and post-installed R-TFIX-CAP15 insulation cap
- Pre-assembled screw saves time and labour

APPLICATIONS

- External Thermal Insulation Composite Systems (ETICS)
- Polystyrene (EPS) boards
- Mineral wool (MW) boards
- Polyurethane (PU) boards
- Cork boards
- Light wood wool building boards

BASE MATERIALS

- Approved for use in:
- Concrete C12/15-C50/60 (Use category A)
 - External wall panel of concrete C 16/20 – C50/60 (Use category A)
 - Solid Brick (Use category B)
 - Solid Sand-lime Brick (Use category B)
 - Vertically-perforated clay block (Use category C)
 - Reinforced components of lightweight aggregate concrete (Use category D)
 - Aerated Concrete Block (Use category E)

INSTALLATION GUIDE

R-TFIX - TOOL - CSM

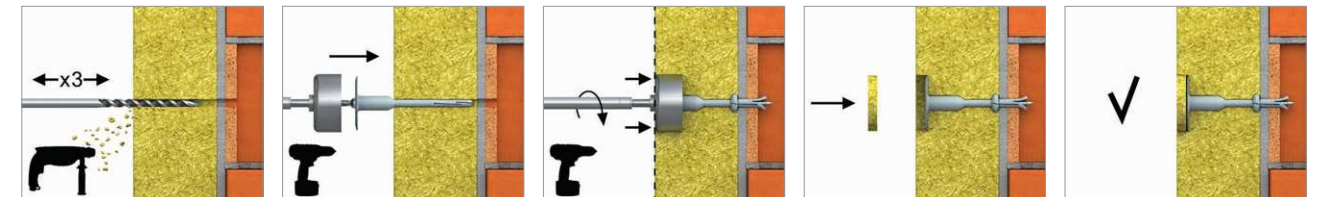

R-TFIX - TOOL - BLACK + R-KWX

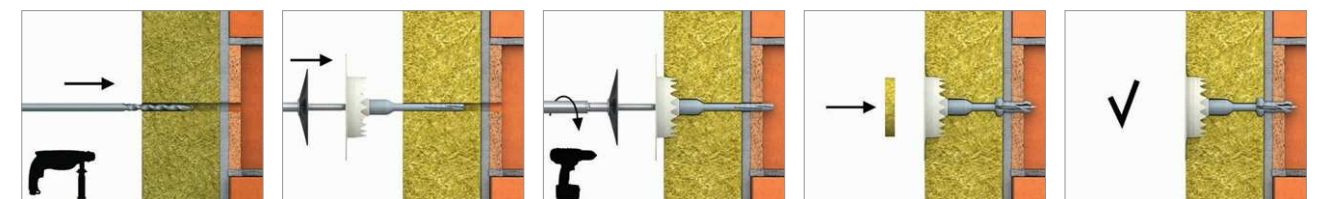

R-TFIX - TOOL - GREY

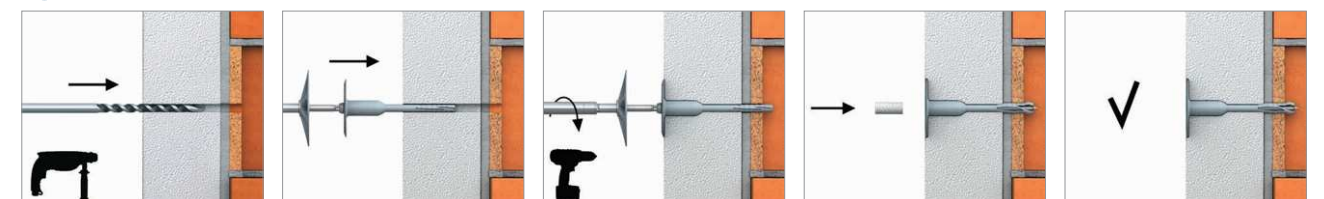

R-TFIX-8S-X UNIVERSAL FACADE FIXINGS

INSTALLATION GUIDE (cont.)

1. Drill a hole of required diameter and depth
2. Drilling depth of min 35mm in A,B,C,D materials and 75mm in Aerated Concrete Block.
3. Clean drilled hole 3 times.
4. Insert driver bit into recess in head moulding of R-TFIX-8S screw.
5. Insert the fixing into the drilled hole.
6. After inserting the fixing in the hole, the plate should be pressed against the thermal insulation surface.
7. Embedment depth of min 25mm in A,B,C,D materials and 65mm in Aerated Concrete Block.
8. Apply steady axial pressure, ensuring the disc of the setting tool is kept perpendicular to the fixing axis.
9. Steadily drive in the screw with high revs until fixing is secure (when disc touches insulation surface).

PRODUCT INFORMATION

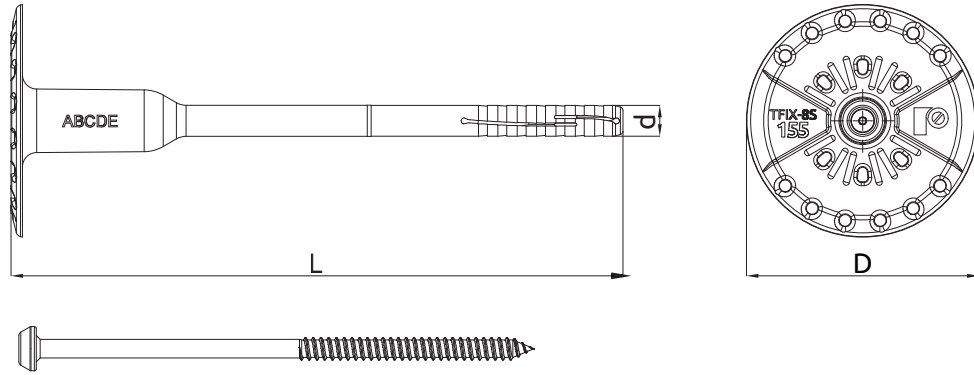

Size	Product Code	Fixing			Fixture	
		Diameter	Plate diameter	Length	Recommended thickness	
		d [mm]	D [mm]	L [mm]	t _{fix} A, B, C, D [mm]	t _{fix} E [mm]
Ø08	R-TFIX-8S-115-X	8	60	115	80	40
	R-TFIX-8S-135-X	8	60	135	100	60
	R-TFIX-8S-155-X	8	60	155	120	80
	R-TFIX-8S-175-X	8	60	175	140	100
	R-TFIX-8S-195-X	8	60	195	160	120
	R-TFIX-8S-215-X	8	60	215	180	140
	R-TFIX-8S-235-X	8	60	235	200	160
	R-TFIX-8S-255-X	8	60	255	220	180
	R-TFIX-8S-275-X	8	60	275	240	200
	R-TFIX-8S-295-X	8	60	295	260	220
	R-TFIX-8S-315-X	8	60	315	280	240
	R-TFIX-8S-335-X	8	60	335	300	260
	R-TFIX-8S-355-X	8	60	355	320	280
	R-TFIX-8S-375-X	8	60	375	340	300
	R-TFIX-8S-395-X	8	60	395	360	320
	R-TFIX-8S-415-X	8	60	415	380	340
R-TFIX-8S-435-X	8	60	435	400	360	
R-TFIX-8S-455-X	8	60	455	420	380	

INSTALLATION DATA

Size	A, B, C, D	A - external panel	E
Fixing diameter	d	[mm]	8
Hole diameter in substrate	d ₀	[mm]	8
Min. installation depth	h _{nom}	[mm]	25
Min. hole depth in substrate	h ₀	[mm]	35
Min. hole depth in substrate - countersunk mounting	h ₀	[mm]	45
Min. substrate thickness	h _{min}	[mm]	100
Min. spacing	s _{min}	[mm]	100
Min. edge distance	c _{min}	[mm]	100

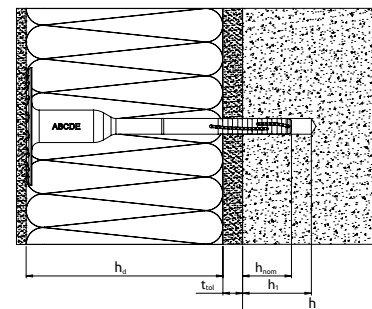

R-TFIX-8S-X UNIVERSAL FACADE FIXINGS

BASIC PERFORMANCE DATA

Performance data for single anchor without influence of edge distance and spacing

Substrate	Concrete C12/15	Concrete min. C16/20	External wall panel of concrete	Solid clay brick min 20MPa (eg M20/2.0)	Sand-lime brick min. 30MPa	Hollow brick 15MPa	Prefabricated reinforced concrete components of lightweight aggregate concrete 4MPa	Autoclaved aerated concrete AAC 4MPa
Effective embedment depth h _{ef}	[mm]	25	25	25	25	25	25	65
MEAN ULTIMATE LOAD N _{Rk,m}								
R-TFIX-8S-X	[kN]	1.64	2.03	2.03	1.78	1.94	1.13	1.12
CHARACTERISTIC LOAD N _{Rk}								
R-TFIX-8S-X	[kN]	1.20	1.50	1.50	1.50	1.50	0.90	0.90
DESIGN LOAD N _{Ed}								
R-TFIX-8S-X	[kN]	0.60	0.75	0.75	0.75	0.75	0.45	0.45
RECOMMENDED LOAD N _{Rec}								
R-TFIX-8S-X	[kN]	0.43	0.54	0.54	0.54	0.54	0.32	0.32

Fixing type	R-TFIX-8SX	
Plate resistance	[kN]	2.04
Plate stiffness	[kN/mm]	0.6
Point thermal transmittance	[W/K]	0,001 - 0,002

ASSOCIATED PRODUCTS



RT-SDSA
Drill bits Aggressor SDS plus



RT-SDSB
Drill bits Brickdrill SDS plus



RT-SDSR
Drill bits Rebardrill SDS plus



R-TFIX-TOOL-GREY
Setting tool

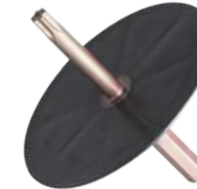

R-TFIX-TOOL-BLACK
Setting tool



R-TFIX-TOOL-CSM
Setting tool

R-TFIX-8M FACADE FIXING WITH METAL NAIL

Versatile hammer-in facade fixing with steel nail recommended for ETICS.



FEATURES AND BENEFITS

- Quick and easy installation in all substrates (categories A,B,C,D,E)
- Unique sleeve compression zone for precision installations.
- Reduced point thermal transmittance to 0.001W/K thanks to high steel nail overmould, which decreases facade heat losses
- Highest loads with anchoring zone reduced in length to 25 mm
- Excellent plate stiffness (value 1.0 kN/mm) ensures smooth elevation surface and stable insulation system.
- Increased head diameter enabling centric hammer driving for improved installation comfort
- Pre-assembled components of the fixing allow you to save time

APPLICATIONS

- External Thermal Insulation Composite Systems (ETICS)
- Polystyrene (EPS) boards
- Mineral wool (MW) boards
- Polyurethane (PU) boards
- Cork boards
- Light wood wool building boards

BASE MATERIALS

- Approved for use in:
- Concrete C12/15-C50/60 (Use category A)
 - Concrete C16/20 (Use category A)
 - Concrete C20/25-C50/60 (Use category A)
 - External wall panel of concrete C 16/20 – C50/60 (Use category A)
 - Solid Brick (Use category B)
 - Solid Sand-lime Brick (Use category B)
 - Hollow Sand-lime Brick (Use category C)
 - Vertically-perforated clay block (Use category C)

INSTALLATION GUIDE

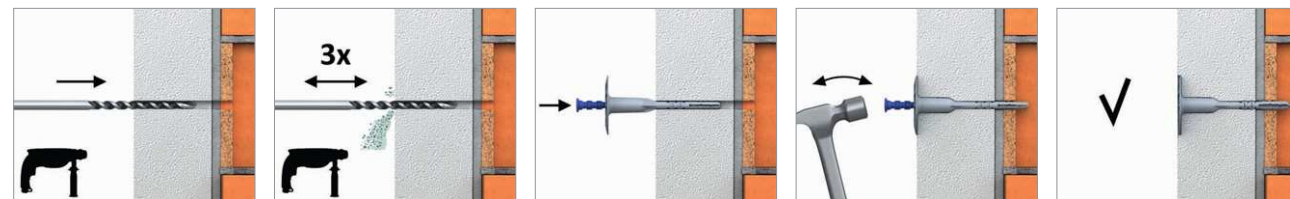

1. Drill a hole of required diameter and depth
2. Drilling depth of min 35mm in A,B,C,D materials and 75mm in Aerated Concrete Block.
3. Clean drilled hole 3 times.
4. Bottom side of the plate must be flush with the ETICS.
5. Embedment depth of min 25mm in A,B,C,D materials and 65mm in Aerated Concrete Block.
6. Hammer the nail into the plastic sleeve until fixing is secure and flush with insulation material.
7. In soft insulation panels the fixing should be combined with insulation retaining plates KWL-90, KWL-110, KWL-140.

R-TFIX-8M FACADE FIXING WITH METAL NAIL

PRODUCT INFORMATION

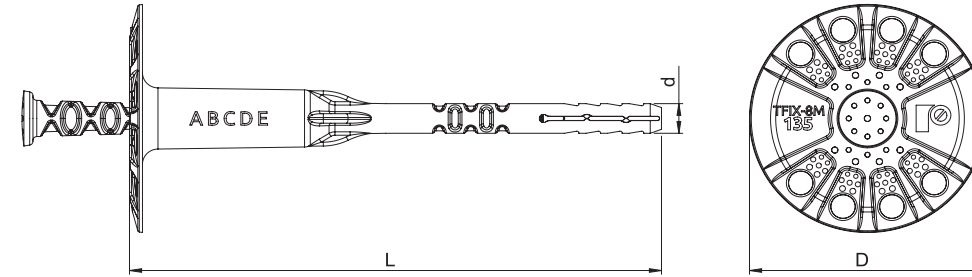

Size	Product Code	Fixing			Fixture	
		Diameter	Plate diameter	Length	Recommended thickness	
		d [mm]	D [mm]	L [mm]	t _{fix} A, B, C, D [mm]	t _{fix} E [mm]
Ø08	R-TFIX-8M-135	8	60	135	100	60
	R-TFIX-8M-155	8	60	155	120	80
	R-TFIX-8M-175	8	60	175	140	100
	R-TFIX-8M-195	8	60	195	160	120
	R-TFIX-8M-215	8	60	215	180	140
	R-TFIX-8M-235	8	60	235	200	160
	R-TFIX-8M-255	8	60	255	220	180
R-TFIX-8M-275	8	60	275	240	200	
R-TFIX-8SX-295	8	60	295	260	220	

INSTALLATION DATA

Size		A, B, C, D	A - external panel	E
Fixing diameter	d	[mm]	8	8
Hole diameter in substrate	d _o	[mm]	8	8
Min. installation depth	h _{nom}	[mm]	25	65
Min. hole depth in substrate	h _o	[mm]	35	75
Min. substrate thickness	h _{min}	[mm]	100	100
Min. spacing	s _{min}	[mm]	100	100
Min. edge distance	c _{min}	[mm]	100	100

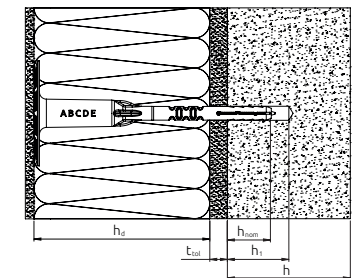

BASIC PERFORMANCE DATA

Performance data for single anchor without influence of edge distance and spacing

Substrate		Concrete C12/15	Concrete min. C16/20	External wall panel of concrete	Solid clay brick min. 20MPa (eg Mz20/Z.0)	Sand-lime brick min. 30MPa	Sand-lime hollow block min. 20MPa	Hollow brick 15MPa	Prefabricated reinforced components of lightweight aggregate concrete 4MPa	Autoclaved aerated concrete AAC 4MPa
Effective embedment depth h _{ef}	[mm]	25	25	25	25	25	25	25	25	25
MEAN ULTIMATE LOAD N _{Ru,m}										
R-TFIX-8M	[kN]	1.41	1.54	1.41	1.54	1.54	1.41	0.64	0.64	1.28
CHARACTERISTIC LOAD N _{Rk}										
R-TFIX-8M	[kN]	1.10	1.20	1.10	1.20	1.20	1.10	0.50	0.50	1.00
DESIGN LOAD N _{Rd}										
R-TFIX-8M	[kN]	0.55	0.60	0.55	0.60	0.60	0.55	0.25	0.25	0.50
RECOMMENDED LOAD N _{rec}										
R-TFIX-8M	[kN]	0.39	0.43	0.39	0.43	0.43	0.39	0.18	0.18	0.36

Fixing type		R-TFIX-8M
Plate resistance	[kN]	1.53
Plate stiffness	[kN/mm]	1
Point thermal transmittance	[W/K]	0.001

R-TFIX-8M FACADE FIXING WITH METAL NAIL

ASSOCIATED PRODUCTS



RT-SDSA
Drill bits Aggressor SDS plus



RT-SDSB
Drill bits Brickdrill SDS plus



RT-SDSR
Drill bits Rebardrill SDS plus



R-KFS-63
Counterbore cutter



R-HDH-0600
Dead Blow Hammer

TFIX-8P FACADE FIXING WITH PLASTIC PIN

Versatile hammer-in facade fixing with plastic nail recommended for ETICS



FEATURES AND BENEFITS

- Installation in all base materials (categories A,B,C,D,E)
- The plastic nail reduces heat transmission (value 0.0W/K)
- Pre-assembled expansion nail saves time and labour.
- Unique nylon pin design reinforced with glass fibre allows fast and trouble-free installation with correct expansion of the plug.
- Expansion zone designed for low embedment depths, reducing the amount of drilling required.
- Can be used in combination with additional KWL plate - 90, 110 or 140mm diameter.

APPLICATIONS

- External Thermal Insulation Composite Systems (ETICS)
- Polystyrene (EPS) boards
- Polyurethane (PU) boards
- Mineral wool
- Lightweight wood wool building boards
- Cork boards

BASE MATERIALS

- Approved for use in:
- Concrete C12/15-C50/60 (Use category A)
 - Solid Brick (Use category B)
 - Solid Sand-lime Brick (Use category B)
 - Hollow Brick (Use category C)
 - Hollow Sand-lime Brick (Use category C)
 - Vertically-perforated clay block (Use category C)
 - Lightweight Concrete Block (Use category C)
 - Hollow Lightweight Concrete Block (Use category C)
 - Reinforced components of lightweight aggregate concrete (Use category D)
 - Aerated Concrete Block (Use category E)

INSTALLATION GUIDE



- Drill a hole of required diameter and depth
- Clean the hole
- Bottom side of the plate must be flush with the ETICS.
- Lightly tap the plastic nail into the plastic sleeve until fixing is secure and flush with insulation material.
- Embedment depth of min 25 in masonry, perforated materials and lightweight concrete blocks and 65mm in aerated concrete.
- In soft insulation panels the fixing should be combined with insulation retaining plates KWL-90, KWL-110, KWL-140.

PRODUCT INFORMATION

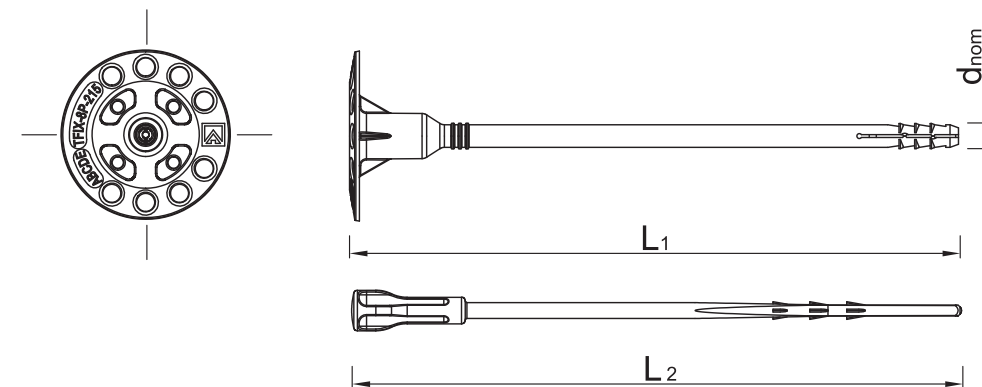

TFIX-8P FACADE FIXING WITH PLASTIC PIN

PRODUCT INFORMATION

Size	Product Code	Fixing			Fixture	
		Diameter	Plate diameter	Length	Recommended thickness	
		d [mm]	D [mm]	L [mm]	t _{fix} A, B, C, D [mm]	t _{fix} E [mm]
Ø08	TFIX-8P-115-2	8	60	115	80	40
	TFIX-8P-135-2	8	60	135	100	60
	TFIX-8P-155-2	8	60	155	120	80
	TFIX-8P-175-2	8	60	175	140	100
	TFIX-8P-195-2	8	60	195	160	120
	TFIX-8P-215-2	8	60	215	180	140

INSTALLATION DATA

Size			A, B, C, D	E
Fixing diameter	d	[mm]	8	8
Hole diameter in substrate	d ₀	[mm]	8	8
Min. installation depth	h _{nom}	[mm]	25	65
Min. hole depth in substrate	h ₀	[mm]	40	80
Min. substrate thickness	h _{min}	[mm]	100	110
Min. spacing	s _{min}	[mm]	100	100
Min. edge distance	c _{min}	[mm]	100	100

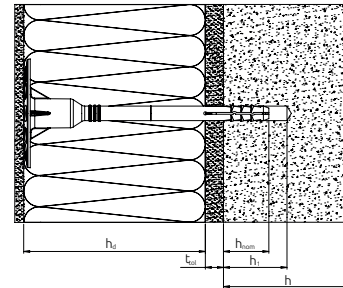

BASIC PERFORMANCE DATA

Performance data for single anchor without influence of edge distance and spacing

Substrate	Concrete C16/20	Concrete C12/15	Solid brick	Sand-lime solid brick	Perforated ceramic brick	Sand-lime hollow brick	Lightweight concrete solid block	Lightweight concrete hollow block	Lightweight concrete	Autoclaved aerated concrete AAC 6MPa	
Effective embedment depth h _{ef} [mm]	25	25	25	25	25	25	25	25	25	65	
CHARACTERISTIC LOAD N_{rk}											
TFIX-8P [kN]	0.50	0.40	0.50	0.50	0.30	0.30	0.30	0.30	0.30	0.50	
DESIGN LOAD N_{rd}											
TFIX-8P [kN]	0.25	0.20	0.25	0.25	0.15	0.15	0.15	0.15	0.15	0.15	
RECOMMENDED LOAD N_{rec}											
TFIX-8P [kN]	0.18	0.14	0.18	0.18	0.11	0.11	0.11	0.11	0.11	0.11	

Fixing type	TFIX-8P	
Plate resistance [kN]	1.38	
Plate stiffness [kN/mm]	0.3	
Point thermal transmittance [W/K]	0	

ASSOCIATED PRODUCTS



RT-SDSA
Drill bits Aggressor SDS plus



RT-SDSB
Drill bits Brickdrill SDS plus



RT-SDSR
Drill bits Rebardrill SDS plus



R-HDH-0600
Dead Blow Hammer

MBA/MBA-SS FACADE FIXING

Fire-resistant metal insulation fixing

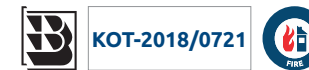

FEATURES AND BENEFITS

- Metal facade fixing, recommended for use when fire resistance (F120) is a requirement
- Fast and simple hammer-set installation reduces working times.
- Extensive dimensional range allows anchorage of insulation boards up to 250mm thick
- Accessory spreader plate, MKC (85mm diameter) also available for installation of soft insulation materials such as mineral wool.

APPLICATIONS

- Mineral wool
- Glass wool
- Lightweight wood wool building boards
- Lightweight recycled panels
- Polystyrene (EPS) boards
- Polyurethane (PU) boards

BASE MATERIALS

- Approved for use in:
- Concrete C12/15-C50/60 (Use category A)
 - Solid Brick (Use category B)
 - Solid Sand-lime Brick (Use category B)
 - Aerated Concrete Block (Use category E)

INSTALLATION GUIDE

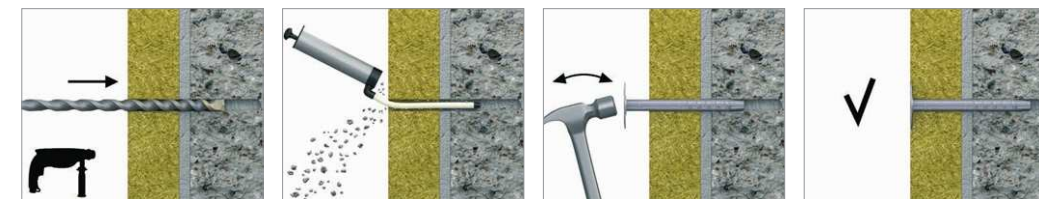

1. Drill a hole of required diameter and depth
2. With a hammer, lightly tap MBA fixing (with MKC washer where applicable) through the insulation material into hole, until fixing depth is reached.

PRODUCT INFORMATION

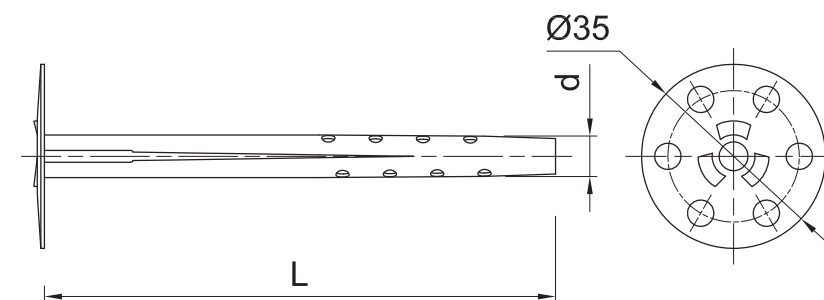

Size	Product Code	Fixing [mm]			Fixture [mm]
		Diameter	Plate diameter	Length	Max. thickness
		d	D	L	t _{fix}
Ø08	MBA-08090 / MBA-SS-08090	8	35	90	40
	MBA-08110 / MBA-SS-08110	8	35	110	60
	MBA-08140 / MBA-SS-08140	8	35	140	90
	MBA-08170 / MBA-SS-08170	8	35	170	120
	MBA-08200 / MBA-SS-08200	8	35	200	150
	MBA-08250 / MBA-SS-08250	8	35	250	200
MBA-08300 / MBA-SS-08300	8	35	300	250	

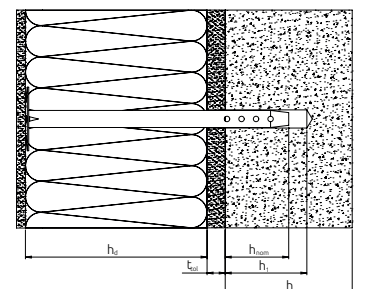

MBA/MBA-SS FACADE FIXING

INSTALLATION DATA

Size			A, B	E
Fixing diameter	d	[mm]	8	8
Hole diameter in substrate	d ₀	[mm]	8	-
Min. installation depth	h _{nom}	[mm]	35	50
Min. hole depth in substrate	h ₀	[mm]	30	-
Min. substrate thickness	h _{min}	[mm]	80	80
Min. spacing	s _{min}	[mm]	75	75
Min. edge distance	c _{min}	[mm]	75	75

BASIC PERFORMANCE DATA

Performance data for single anchor without influence of edge distance and spacing

Substrate		Concrete	Solid brick	Sand-lime solid brick	Perforated ceramic brick	Sand-lime hollow brick	Autoclaved aerated concrete
Effective embedment depth h _{ef}	[mm]	30	30	30	50	30	50
MEAN ULTIMATE LOAD N _{Ru,m}							
MBA-SS	[kN]	0.88	0.75	0.80	0.40	0.50	1.05
CHARACTERISTIC LOAD N _{Rk}							
MBA-SS	[kN]	0.75	0.50	0.60	0.22	0.37	0.82
DESIGN LOAD N _{Rd}							
MBA-SS	[kN]	0.30	0.20	0.24	0.09	0.15	0.41
RECOMMENDED LOAD N _{rec}							
MBA-SS	[kN]	0.21	0.14	0.17	0.06	0.10	0.29

ASSOCIATED PRODUCTS



RT-SDSA
Drill bits Aggressor SDS plus



RT-SDSB
Drill bits Brickdrill SDS plus



RT-SDSR
Drill bits Rebardrill SDS plus



R-KFS-90/2
Counterbore cutter



R-HDH-0600
Dead Blow Hammer

KCX TUBED INSULATION WASHER

Insulation washer with integral cap suitable for attachment of insulation layers to wooden and sheet metal substrates

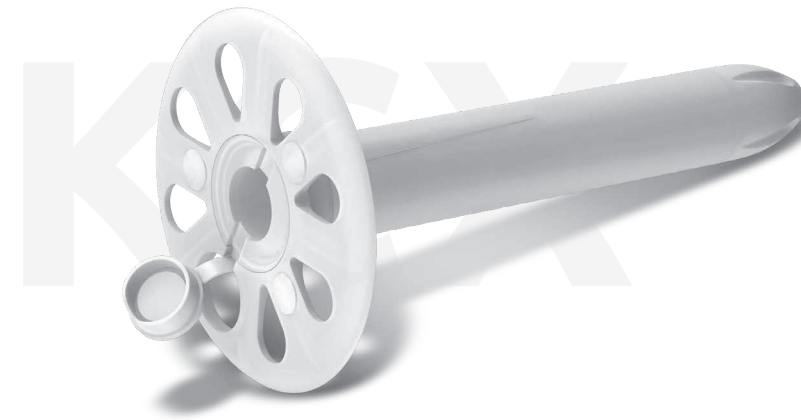

FEATURES AND BENEFITS

- Recommended for the attachment of ETICS to wooden substrates using UC screws, or to sheet metal using WB screws (allows setting without pre-drilling, thus saving a stage of installation)
- Special design of integral fastener cap allows reduction of thermal bridges to 0,001W/K.
- Design with long tube allows to use short length of the screw for best cost effective solution to fix large insulation thickness.
- Consistent and reliable holding force
- Quick, simple and clean installation.
- Can be used in combination with additional KWL plate - 90, 110 or 140mm diameter.

APPLICATIONS

- External Thermal Insulation Composite Systems (ETICS)

BASE MATERIALS

- Approved for use in:
- Metal Sheet & Profiles
 - Wood
 - Timber
 - Chipboard
 - Concrete

INSTALLATION GUIDE

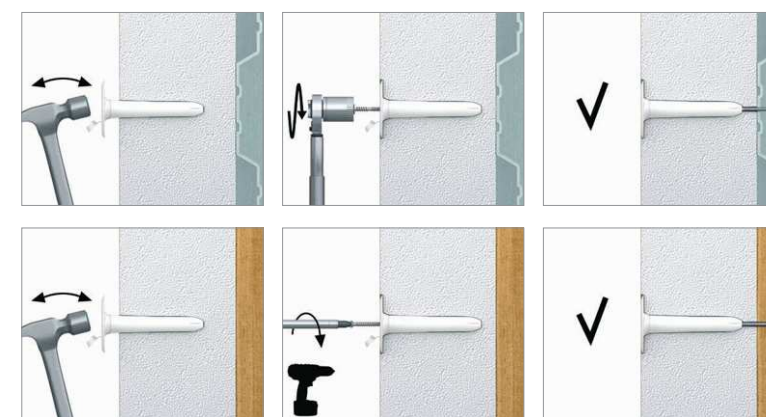

- Lightly insert KCX washer into surface of insulation material.
- Drive the required screw through the washer and insulation material into the substrate, until fixing depth is reached.
- In wooden substrates the washer is recommended for use with the UC chipboard screw.
- In sheet metal the washer is recommended for use with either the WB or WX self-drilling screw.

KCX TUBED INSULATION WASHER

PRODUCT INFORMATION

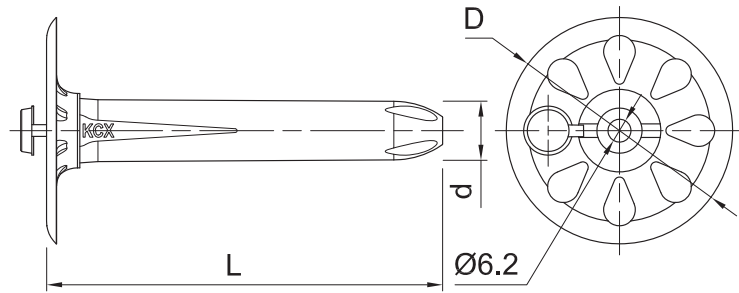

Size	Product Code	Screw	Screw [mm]		Fixture [mm]	Diameter		Length
			Diameter	Length	Max. thickness	D	L	
			d [mm]	L [mm]	t _{fix} [mm]	[mm]	[mm]	
KCX with screw to wood								
Ø5	KCX-055	R-UC-5050	5	50	70	60	55	
		R-UC-5060	5	60	80	60	55	
		R-UC-5070	5	70	90	60	55	
		R-UC-5080	5	80	100	60	55	
		R-UC-5090	5	90	110	60	55	
Ø6	KCX-105	R-UC-6050	6	50	120	60	105	
		R-UC-6060	6	60	130	60	105	
		R-UC-6070	6	70	140	60	105	
		R-UC-6080	6	80	150	60	105	
		R-UC-6090	6	90	160	60	105	
	KCX-165	R-UC-6100	6	100	170	60	105	
		R-UC-6050	6	50	180	60	165	
		R-UC-6060	6	60	190	60	165	
		R-UC-6070	6	70	200	60	165	
		R-UC-6080	6	80	210	60	165	
R-UC-6090		6	90	220	60	165		
R-UC-6100		6	100	230	60	165		
R-UC-6110		6	110	240	60	165		
R-UC-6120		6	120	250	60	165		
R-UC-6140		6	140	270	60	165		
R-UC-6160	6	160	290	60	165			
KCX with selfdrilling screw to metal sheet								
Ø4.8	KCX-055	R-WX-48050	4.8	50	70	60	55	
		R-WX-48060	4.8	60	80	60	55	
		R-WX-48070	4.8	70	90	60	55	
		R-WX-48080	4.8	80	100	60	55	
		R-WX-48100	4.8	100	110	60	55	
	KCX-105	R-WX-48050	4.8	50	120	60	105	
		R-WX-48060	4.8	60	130	60	105	
		R-WX-48070	4.8	70	140	60	105	
		R-WX-48080	4.8	80	150	60	105	
		R-WX-48100	4.8	100	170	60	105	
	KCX-165	R-WX-48050	4.8	50	180	60	165	
		R-WX-48060	4.8	60	190	60	165	
		R-WX-48070	4.8	70	200	60	165	
		R-WX-48080	4.8	80	210	60	165	
		R-WX-48100	4.8	100	230	60	165	
		R-WX-48120	4.8	120	250	60	165	
		R-WX-48140	4.8	140	270	60	165	
		R-WX-48160	4.8	160	290	60	165	
		R-WX-48180	4.8	180	310	60	165	
		R-WX-48200	4.8	200	330	60	165	
R-WX-48240	4.8	240	370	60	165			
R-WX-48300	4.8	300	430	60	165			
KCX with screw to concrete								
Ø6.1	KCX-055	R-WBT-61075	6.1	75	90	60	55	
		R-WBT-61100	6.1	100	110	60	55	
	KCX-105	R-WBT-61075	6.1	75	140	60	105	
		R-WBT-61100	6.1	100	160	60	105	
		R-WBT-61120	6.1	120	180	60	105	
	KCX-165	R-WBT-61075	6.1	75	200	60	165	
		R-WBT-61100	6.1	100	230	60	165	
		R-WBT-61120	6.1	120	250	60	165	
		R-WBT-61140	6.1	140	270	60	165	
		R-WBT-61160	6.1	160	290	60	165	
		R-WBT-61180	6.1	180	310	60	165	
		R-WBT-61200	6.1	200	330	60	165	
		R-WBT-61220	6.1	220	430	60	165	
		R-WBT-61240	6.1	240	450	60	165	
		R-WBT-61260	6.1	260	470	60	165	
R-WBT-61300	6.1	300	510	60	165			

KCX TUBED INSULATION WASHER

INSTALLATION DATA

Size		Timber	Steel	Concrete
Hole diameter in substrate	d ₀ [mm]	-	-	5
Min. installation depth	h _{nom} [mm]	20	24	30
Min. hole depth in substrate	h ₀ [mm]	-	-	35
Min. substrate thickness	h _{min} [mm]	20	24	30.80
Min. spacing	s _{min} [mm]	100	100	120
Min. edge distance	c _{min} [mm]	100	100	50
Fixing diameter	c _{min} [mm]	5	6	6.1

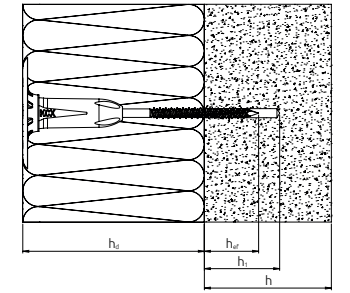

BASIC PERFORMANCE DATA

Performance data for single anchor without influence of edge distance and spacing

Substrate		Timber			OSB	Steel			Timber	Concrete
Effective embedment depth h _{ef}	[mm]	20	24	19	18	0.5	0.63	0.75	0.88	30
CHARACTERISTIC LOAD N_{rk}										
KCX + UC 5	[kN]	1.29	-	-	-	-	-	-	-	-
KCX + UC 6	[kN]	-	1.29	-	-	-	-	-	-	-
KCX + WO 4.8	[kN]	-	-	1.29	1.29	0.66	0.86	1.29	-	-
KCX + WX 4.8	[kN]	-	-	-	-	-	-	1.29	1.29	-
KCX + WBT 6.1	[kN]	-	-	-	-	-	-	-	-	1.29
DESIGN LOAD N_{rd}										
KCX + UC 5	[kN]	0.65	-	-	-	-	-	-	-	-
KCX + UC 6	[kN]	-	0.65	-	-	-	-	-	-	-
KCX + WO 4.8	[kN]	-	-	0.65	0.65	0.50	0.65	0.65	-	-
KCX + WX 4.8	[kN]	-	-	-	-	-	-	0.65	0.65	-
KCX + WBT 6.1	[kN]	-	-	-	-	-	-	-	-	0.65

R-KC INSULATION WASHERS

Insulation washer with integral cap suitable for attachment of insulation layers to wooden and sheet metal substrates

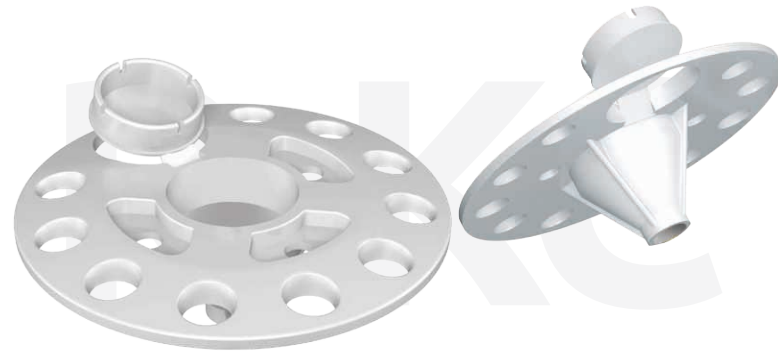

FEATURES AND BENEFITS

- Recommended for the attachment of ETICS to wooden substrates using UC screws, or to sheet metal using WB screws.
- Special design of integral fastener cap allows reduction of thermal bridges.
- Consistent and reliable holding force
- Quick, simple and clean installation.
- Can be used in combination with additional KWL plate - 90, 110 or 140mm diameter.

APPLICATIONS

- External Thermal Insulation Composite Systems (ETICS)
- Polystyrene (EPS) boards
- Mineral wool (MW) boards
- Polyurethane (PU) boards

BASE MATERIALS

- Approved for use in:
- Metal Sheet & Profiles
 - Wood

INSTALLATION GUIDE

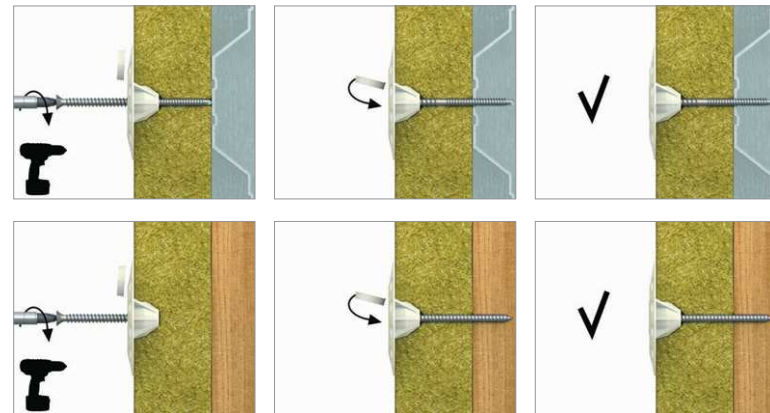

- Lightly insert KC washer into surface of insulation material.
- Drive the required screw through the washer and insulation material into the substrate, until fixing depth is reached.
- In wooden substrates the washer is recommended for use with the UC chipboard screw.
- In sheet metal the washer is recommended for use with either the WB or WX self-drilling screw.

PRODUCT INFORMATION

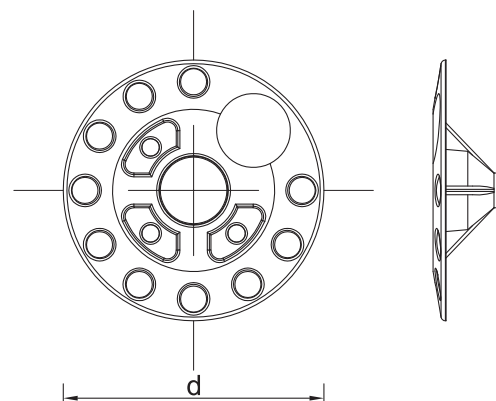

R-KC INSULATION WASHERS

PRODUCT INFORMATION (cont.)

Size	Product Code	Fixing [mm]			Fixture [mm]
		Diameter d	Plate diameter D	Length L	Max. thickness t _{fix}
KC with screw to wood					
Ø5	KC + UC-5050	5	50	60	30
	KC + UC-5060	5	60	60	40
	KC + UC-5070	5	70	60	50
	KC + UC-5080	5	80	60	60
	KC + UC-5090	5	90	60	70
	KC + UC-50100	5	100	60	80
Ø6	KC + UC-60100	6	100	60	75
	KC + UC-60120	6	120	60	95
	KC + UC-60140	6	140	60	115
	KC + UC-60160	6	160	60	135
KC + UC-60200	6	200	60	175	
KC with selfdrilling screw to steel sheet					
Ø5	KC + WB-48100	4.8	100	60	90
	KC + WB-48120	4.8	120	60	110
	KC + WB-48140	4.8	140	60	130
	KC + WB-48160	4.8	160	60	150
	KC + WB-48170	4.8	170	60	160
	KC + WB-48180	4.8	180	60	170
	KC + WB-48200	4.8	200	60	190
	KC + WB-48220	4.8	220	60	210

INSTALLATION DATA

Size	Timber		Steel
Fixing diameter	d	[mm]	5
Min. installation depth	h _{nom}	[mm]	20
Min. substrate thickness	h _{min}	[mm]	20
Min. spacing	s _{min}	[mm]	100
Min. edge distance	c _{min}	[mm]	100

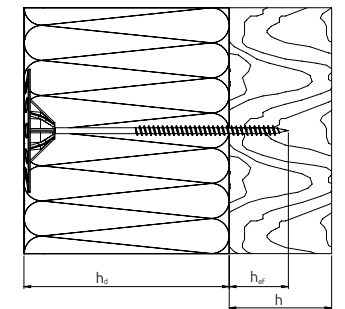

BASIC PERFORMANCE DATA

Performance data for single anchor without influence of edge distance and spacing

Substrate		Timber			Steel
		20	25	0.75	
Effective embedment depth h _{ef}		[mm]	20	25	0.75
MEAN ULTIMATE LOAD N_{Ru,m}					
KC + UC Ø5	[kN]	0.78	-	-	
KC + UC Ø6	[kN]	-	0.98	-	
KC + WB	[kN]	-	-	0.86	
CHARACTERISTIC LOAD N_{Rk}					
KC + UC Ø5	[kN]	0.73	-	-	
KC + UC Ø6	[kN]	-	0.91	-	
KC + WB	[kN]	-	-	0.81	
DESIGN LOAD N_{Ed}					
KC + UC Ø5	[kN]	0.36	-	-	
KC + UC Ø6	[kN]	-	0.45	-	
KC + WB	[kN]	-	-	0.40	
RECOMMENDED LOAD N_{Rec}					
KC + UC Ø5	[kN]	0.26	-	-	
KC + UC Ø6	[kN]	-	0.32	-	
KC + WB	[kN]	-	-	0.29	

Fixing type	KC		
Plate stiffness	[kN/mm]	0.4	

R-DB CEILING SCREW-IN SOLUTION WITH WASHER

Screw-in system for fastening ceiling and acoustic insulation boards



FEATURES AND BENEFITS

- Easy removable solution helps to replace the insulation board if necessary
- Screw for concrete substrates, TX25 head. Shape and type of the thread specially design to allow connecting to concrete and wood.
- Special zinc flake corrosion-resistant coating for anti-corrosion protection.
- The drill point is designed to provide a fast and hassle-free installation in the steel. Sharp point of the drill prevents movement of the surface of the fixture.
- Wide retaining plate improve pull-through insulation loads for the fixing point
- Flange ensures flush fit to insulation surface.

APPLICATIONS

- Thermal and acoustic insulation
- Ceiling and acoustic insulation boards
- Mineral wool (MW) boards

BASE MATERIALS

- Approved for use in:
- Concrete C20/25-C50/60

INSTALLATION GUIDE

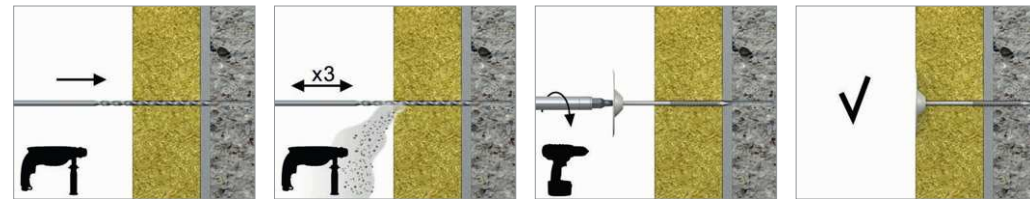

1. Drill a 5mm diameter hole perpendicular to the surface of the substrate
2. Clean drilled hole 3 times.
3. Use a standard bit for installation
4. The upper part of the plate must be flush with surface
5. Properly set insulation fixing

PRODUCT INFORMATION

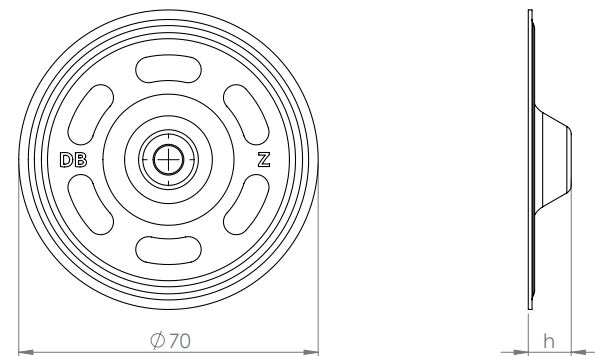

R-DB CEILING SCREW-IN SOLUTION WITH WASHER

PRODUCT INFORMATION (cont.)

Size	Product Code	Screw [mm]	
		Diameter	Plate diameter
		d	D
Ø6.1	R-WBT-61050	6.1	50
	R-WBT-61075	6.1	75
	R-WBT-61090	6.1	90
	R-WBT-61100	6.1	100
	R-WBT-61120	6.1	120
	R-WBT-61140	6.1	140
	R-WBT-61160	6.1	160
	R-WBT-61180	6.1	180
	R-WBT-61200	6.1	200
	R-WBT-61220	6.1	220
R-WBT-61240	6.1	240	
R-WBT-61300	6.1	300	

Size	Product Code	Fixing	Hole depth	Embedment depth	Hole diameter	Thickness	Depth
		Plate diameter					
		D	h ₀	L	d	t	h
Ø70	R-DB-Z	70	30	25	6.5	0.8	10
	R-DB-Z-FL	70	30	25	6.5	0.8	5

INSTALLATION DATA

Size	70		
Hole diameter in substrate	d ₀	[mm]	5
Min. installation depth	h _{nom}	[mm]	25
Min. hole depth in substrate	h ₀	[mm]	30
Min. substrate thickness	h _{min}	[mm]	80
Min. spacing	s _{min}	[mm]	100
Min. edge distance	c _{min}	[mm]	100

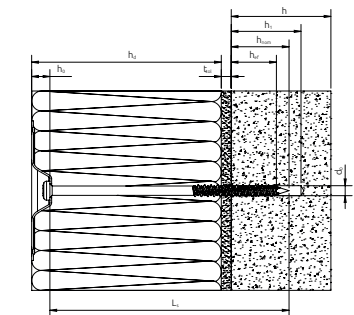

BASIC PERFORMANCE DATA

Property	Value
Design load N _{rd} [kN]	0.50

Size	Product Code	Fixing [mm]			Fixture [mm]
		Diameter	Plate diameter	Length	Max. thickness
		d	D	L	t _{fix}
KC with screw to wood					
Ø5	KC + UC-5050	5	50	60	30
	KC + UC-5060	5	60	60	40
	KC + UC-5070	5	70	60	50
	KC + UC-5080	5	80	60	60
	KC + UC-5090	5	90	60	70
	KC + UC-50100	5	100	60	80
Ø6	KC + UC-60100	6	100	60	75
	KC + UC-60120	6	120	60	95
	KC + UC-60140	6	140	60	115
	KC + UC-60160	6	160	60	135
	KC + UC-60200	6	200	60	175
KC with selfdrilling screw to steel sheet					
Ø5	KC + WB-48100	4.8	100	60	90
	KC + WB-48120	4.8	120	60	110
	KC + WB-48140	4.8	140	60	130
	KC + WB-48160	4.8	160	60	150
	KC + WB-48170	4.8	170	60	160
	KC + WB-48180	4.8	180	60	170
	KC + WB-48200	4.8	200	60	190
	KC + WB-48220	4.8	220	60	210

R-KWL INSULATION RETAINING PLATE

Insulation retaining plate for use in combination with facade fixings from TFIX and KI ranges



FEATURES AND BENEFITS

- Quick and easy application possible with all ETICS fixings.
- Nylon versions ideal for enhanced plate stiffness.
- Polypropylene standard versions are recommended for cost-effective applications.
- A versatile solution for many insulation scenarios.

APPLICATIONS

- External Thermal Insulation Composite Systems (ETICS)
- Polystyrene (EPS) boards
- Mineral wool
- Polyurethane (PU) boards

BASE MATERIALS

- Approved for use in:
- Polystyrene (EPS) Boards
 - Mineral wool (MW) boards

INSTALLATION GUIDE

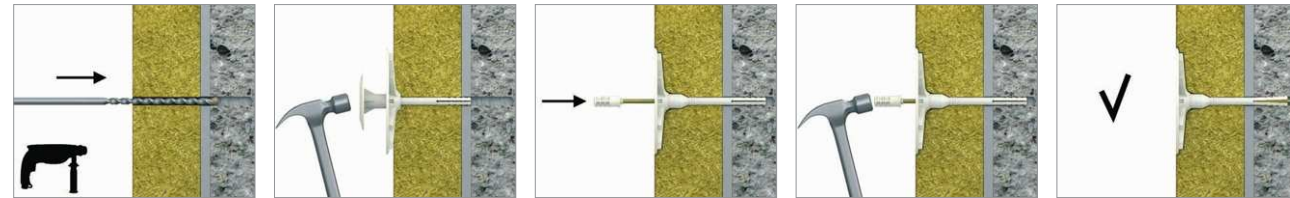

1. Insert chosen TFIX or KI fixing through hole in centre of KWL flange.
2. Follow installation procedure for relevant TFIX or KI fixing.

PRODUCT INFORMATION

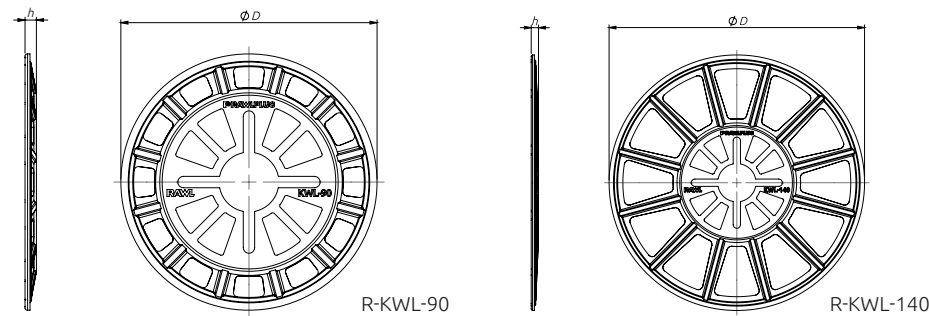

Size	Product Code	Screw [mm]	
		Plate diameter	Length
		D	L
Ø90	R-KWL-090	90	15
Ø110	R-KWL-110	110	15
Ø140	R-KWL-140	140	15

R-KWX INSULATION RETAINING PLATE WITH PERFORATOR

Joining retaining plate with perforator for countersunk installation in mineral wool insulation boards

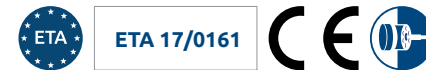

FEATURES AND BENEFITS

- Usage always with screw-in insulation fixing eg. R-TFIX-8SX / KWX
- Wide retaining plate improve pull-through insulation loads for the fixing point
- Allows countersunk installation into all mineral wool-insulation boards with minimal lateral tensile strength and phenolic board
- Accurate countersunk setting automatically sets the fixing flush with the insulation layer
- Permanent contact pressure
- No additional installation tool required
- Quick and easy installation
- Compatible with TFIX-8S-MW insulation cap

APPLICATIONS

- External Thermal Insulation Composite Systems (ETICS)

BASE MATERIALS

- Approved for use in:
- Polystyrene (EPS) Boards
 - Mineral wool (MW) boards

INSTALLATION GUIDE

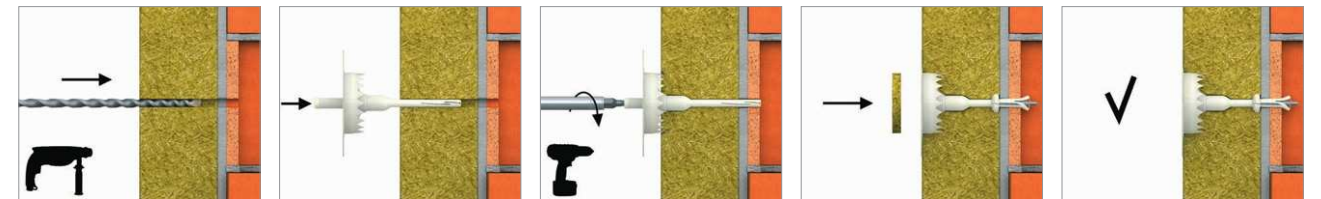

1. Drill a hole of required diameter and depth
2. Drilling depth of min 35mm in A,B,C,D materials and 75mm in Aerated Concrete Block.
3. Clean drilled hole 3 times.
4. Insert R-TFIX-TOOL-BLACK into recess in head moulding of R-TFIX-8SX screw.
5. Insert the fixing into the drilled hole.
6. When using the KWX-63 the teeth should be embedded in the insulation material after hammering.
7. Embedment depth of min 25mm in A,B,C,D materials and 65mm in Aerated Concrete Block.
8. Apply steady axial pressure, ensuring the disc of the setting tool is kept perpendicular to the fixing axis.
9. Steadily drive in the screw with high revs until fixing is secure (when disc touches insulation surface).

PRODUCT INFORMATION

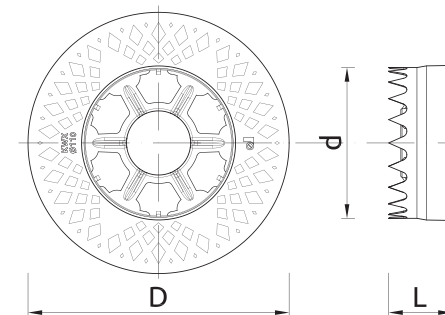

Size	Product Code	Fixing	Drill diameter	Fixing
		Plate diameter		Length
		D	Ø	L
110	R-KWX-110	110	63.5	13.7
63,5	R-KWX-63	63.5	63.5	16.5



Roofing Insulation Fixings

R-GOK Telescopic sleeve with round plate	345
R-WBT Screw for concrete	348
R-WX-T Self-drilling screws for steel	350
R-WO-T Screws for steel	352
R-WW-T Screws for timber	354
R-POK Steel washers	356
R-POW-05, R-POW-07 Oval steel washers	357

OVERVIEW OF OUR RANGE ROOFING INSULATION FIXINGS SELECTOR

ROOFING SCREWS		R-WBT	R-WX	R-WO	R-WW	
TELESCOPIC TUBES & WASHERS	R-GOK-N, R-GOK		✓	✓	✓	✓
	R-POK-040-ALZN R-POK-041-ALZN R-POK-06-ALZN		✓	✓	✓	✓
	R-POW-05-ALZN		✓	✓	✓	✓
	R-POW-07-ALZN		✓	✓	✓	✓
SIZE	SCREW LENGTH [mm]	50-300	50-300	60-300	20-120	
	SCREW THREAD DIAMETER [mm]	6.1	4.8	4.8	5.0	
	TELESCOPIC RANGE [mm]	15-725	15-725	15-725	25-725	
SUBSTRATES	CONCRETE		✓	-	WO +4ALL-8	-
	THIN-WALLED CONCRETE SLABS		✓	-	-	-
	STEEL		-	✓	✓	-
	TIMBER		✓	-	✓	✓
	ORIENTED STRAND BOARD		✓	-	✓	✓
	PLYWOOD		✓	-	✓	✓
APPROVALS	ETA CE	✓	✓	✓	✓	
	NATIONAL APPROVAL	✓	✓	✓	-	

R-GOK TELESCOPIC SLEEVE WITH ROUND PLATE

Telescopic sleeve for flat roof insulation fixings. Combined together with the corresponding screw allows application in all types of substrates.



FEATURES AND BENEFITS

- Impact-resistant material used ensures constant mechanical properties over the lifetime of a roof. Also, retains its properties over a wide temperature range
- Round plate eliminates the need of positioning the fixing during the installation, the bottom part of the connection sleeve is designed to carry very heavy loads during operation of the roof
- Internal sleeve design allows pre-assembly with any Rawlplug roofing screw, shortening installation
- The lower part of the connector telescope has been designed in the shape of a cone with an optimum angle of inclination which significantly affects the speed of its installation
- Guarantees the highest load capacity of the roof construction for both static and dynamic loads in accordance with ETAG006

APPLICATIONS

- Mechanically fastened flexible roof waterproofing membrane



Installation guide movie

BASE MATERIALS

- Approved for use in:
- Concrete
 - Concrete Slab
 - Metal Sheet & Profiles
 - Timber
 - Plywood
 - Chipboard

VERSION

- GOK - Polypropylene
- GOK-N - Nylon

INSTALLATION GUIDE

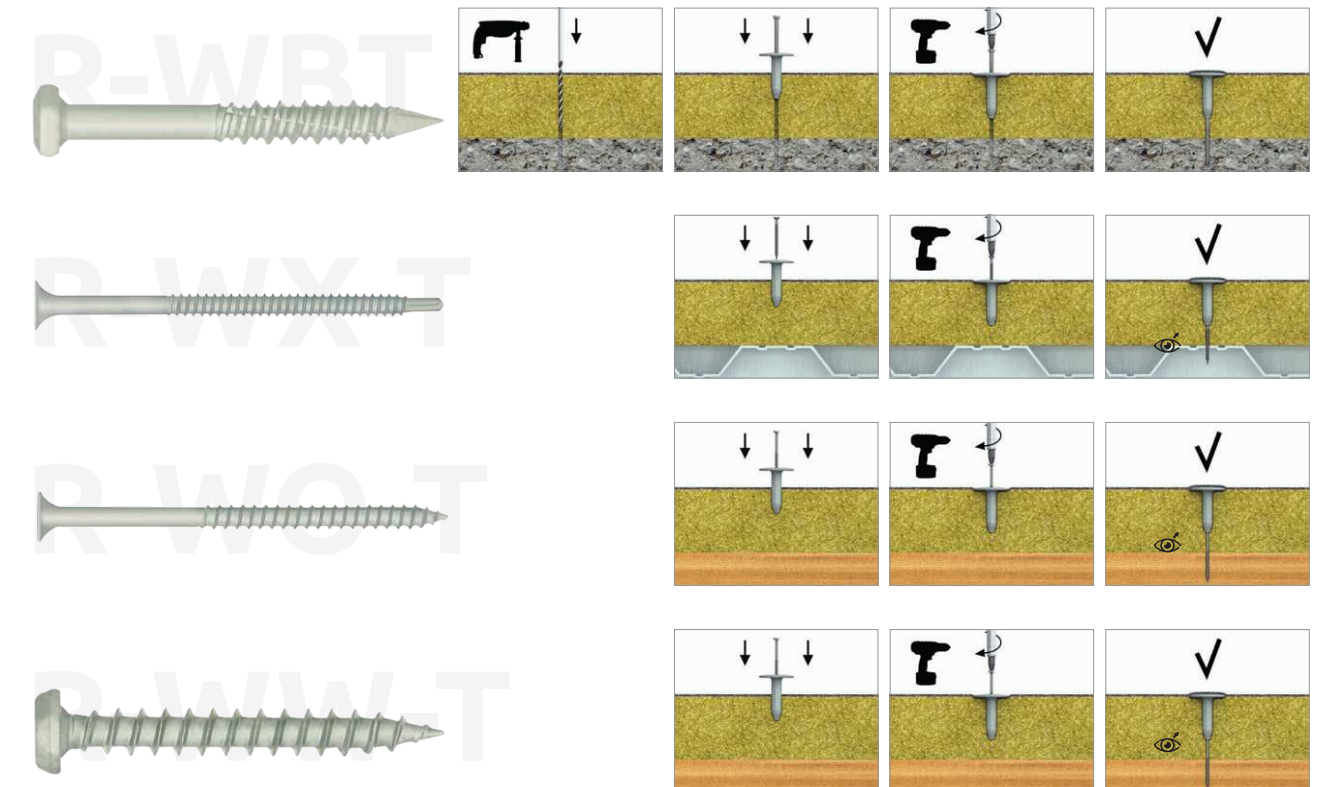

- Drill the hole of required diameter and depth
- Lightly insert plastic sleeve into insulation material
- Using drilling machine, drive the screw into substrate until fixing depth is reached

R-GOK TELESCOPIC SLEEVE WITH ROUND PLATE

PRODUCT INFORMATION

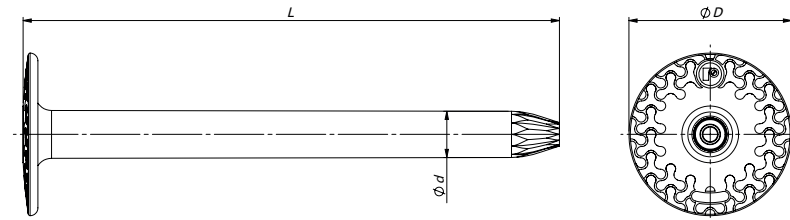

Product Code	Plastic sleeve			Fixture	
	Diameter	Length	Plate diameter	Min. thickness	Max. thickness
	d [mm]	L [mm]	D [mm]	t _{fix} [mm]	t _{fix} [mm]
R-GOK-015	15.5	15	50	30	280
R-GOK-035	15.5	35	50	50	300
R-GOK-065	15.5	65	50	80	330
R-GOK-075	15.5	75	50	90	340
R-GOK-085	15.5	85	50	100	350
R-GOK-095	15.5	95	50	110	360
R-GOK-105	15.5	105	50	120	370
R-GOK-125	15.5	125	50	140	390
R-GOK-135	15.5	135	50	150	400
R-GOK-165	15.5	165	50	180	430
R-GOK-185	15.5	185	50	200	450
R-GOK-225	15.5	225	50	240	490
R-GOK-255	15.5	255	50	270	520
R-GOK-285	15.5	285	50	300	550
R-GOK-325	15.5	325	50	340	590
R-GOK-385	15.5	385	50	400	650
R-GOK-425	15.5	425	50	440	690
R-GOK-525-N	15.5	525	50	540	790
R-GOK-625-N	15.5	625	50	640	890
R-GOK-725-N	15.5	725	50	740	990

INSTALLATION DATA

Size	Steel	Timber, grade C24	Chipboard OSB
Screw diameter	d [mm]	4.8	4.8
Hole diameter in substrate	d ₀ [mm]	-	-
Min. hole depth in substrate	h ₀ [mm]	-	-
Min. installation depth	h _{nom} [mm]	24	18
Min. substrate thickness	h _{min} [mm]	0.5	18
Min. spacing	s _{min} [mm]	120	120
Min. edge distance	c _{min} [mm]	30	30

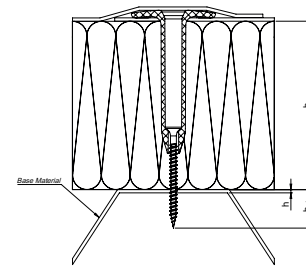

BASIC PERFORMANCE DATA

Substrate	Steel	Timber, grade C24	Chipboard OSB
Effective embedment depth h _{ef} [mm]	0.75	24.00	18.00
MEAN ULTIMATE LOAD N_{Ru,m}			
GOK + WO [kN]	1.66	2.53	2.33
CHARACTERISTIC LOAD N_{Rk}			
GOK + WO [kN]	0.93	1.45	1.08
DESIGN LOAD N_{Rd}			
GOK + WO [kN]	0.46	0.72	0.75
RECOMMENDED LOAD N_{Rrc}			
GOK + WO [kN]	0.33	0.51	0.38

R-GOK TELESCOPIC SLEEVE WITH ROUND PLATE (cont.)

Design performance data

PULL OUT - SCREW FROM SUBSTRATE

Size	Steel	Timber, grade C24	Plywood	Chipboard OSB
Effective embedment depth h _{ef} [mm]	0.5, 0.63, 0.75	24	20	18
TENSION LOAD				
PULL-OUT FAILURE				
Characteristic resistance V _{Rk,D} [kN]	1.20	1.20	1.20	1.20
Design resistance V _{Rd,D} [kN]	1.22	1.22	1.22	1.22
PULL OUT - GOK SLEEVE				
Characteristic resistance V _{Rk,D} [kN]	5.03	9.15	14.50	21.08
Design resistance V _{Rd,D} [kN]	0.80	0.80	0.80	0.80

ASSOCIATED PRODUCTS



RT-SDSA
Drill bits Aggressor SDS plus



RT-SDSR
Drill bits Rebardrill SDS plus



RT-ADAP
Expanders SDS plus Roof System



RT-TD
Drill bits Roof System

R-WBT SCREW FOR CONCRETE

Screw for concrete substrates, TX25 head. Shape and type of the thread specially design to allow connecting to concrete and wood.



FEATURES AND BENEFITS

- Hardened thread surface
- High quality anti-corrosion coating guarantees resistance of 15 Kesternich cycles
- Shape and type of the thread specially design to allow connecting to concrete and wood
- The drill point is designed to provide a fast and hassle-free installation. Sharp point of the drill prevents movement of the surface of the fixture
- Pre-assembly with other component is possible before installation

APPLICATIONS

- Insulation materials in flat roof applications in conjunction with telescopic connector and steel washer

BASE MATERIALS

- Approved for use in:
- Concrete
 - Concrete Slab
 - Timber

INSTALLATION GUIDE

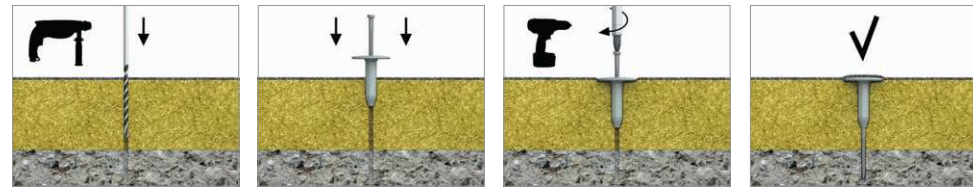

1. Drill the hole of required diameter and depth (where applicable)
2. Lightly insert plastic sleeve into insulation material
3. Using drilling machine, drive the WBT screw into substrate until fixing depth is reached

PRODUCT INFORMATION

Product Code	Plastic sleeve	
	Diameter	Length
	d [mm]	L [mm]
R-WBT-61050	6.1	50
R-WBT-61075	6.1	75
R-WBT-61090	6.1	90
R-WBT-61100	6.1	100
R-WBT-61120	6.1	120
R-WBT-61140	6.1	140
R-WBT-61160	6.1	160
R-WBT-61180	6.1	180
R-WBT-61200	6.1	200
R-WBT-61220	6.1	220
R-WBT-61240	6.1	240
R-WBT-61260	6.1	260
R-WBT-61300	6.1	300

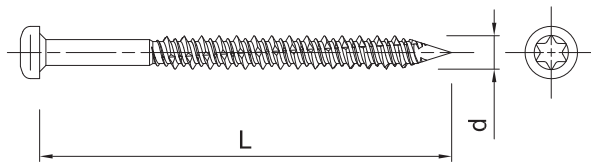

R-WBT SCREW FOR CONCRETE (cont.)

INSTALLATION DATA

Size	Concrete C12/15	Thin-walled slab C16/20	Timber
Screw diameter	d [mm]	6.1	6.1
Hole diameter in substrate	d ₀ [mm]	5	5
Min. hole depth in substrate	h ₀ [mm]	35	25
Min. installation depth	h _{nom} [mm]	30	20
Min. substrate thickness	h _{min} [mm]	35	30
Min. spacing	s _{min} [mm]	120	120
Min. edge distance	c _{min} [mm]	30	30
Screw drive	- [-]	-	TX25

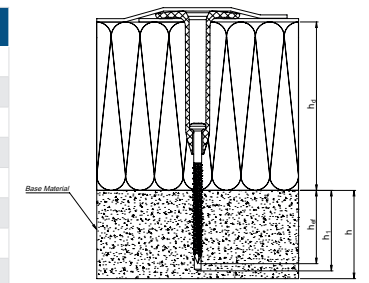

BASIC PERFORMANCE DATA

Substrate	Concrete C12/15	Concrete C20/25	Thin-walled slab C16/20	Timber, grade C24
Effective embedment depth h _{ef} [mm]	30.00	30.00	20.00	30.00
MEAN ULTIMATE LOAD N _{Ru,m}				
GOK + WBT [kN]	2.52	2.52	2.20	2.52
CHARACTERISTIC LOAD N _{Rk}				
GOK + WBT [kN]	2.42	2.46	1.85	2.46
DESIGN LOAD N _{Rd}				
GOK + WBT [kN]	0.96	1.23	0.76	1.23
RECOMMENDED LOAD N _{rec}				
GOK + WBT [kN]	0.69	0.88	0.54	0.88

Design performance data

PULL OUT - SCREW FROM SUBSTRATE

Size	Concrete C12/15	Concrete C20/25	Thin-walled slab C16/20	Timber, grade C24
Effective embedment depth h _{ef} [mm]	30	20	20	30
TENSION LOAD				
PULL-OUT FAILURE				
Characteristic resistance V _{Rk,p} [kN]	2.42	2.25	4.03	1.85
Design resistance V _{Rd,p} [kN]	0.96	0.90	1.59	0.76
PULL OUT -GOK SLEEVE				
Characteristic resistance V _{Rk,p} [kN]				2.46
Design resistance V _{Rd,p} [kN]				1.23

ASSOCIATED PRODUCTS



R-GOK
Telescopic sleeve with round plate



RT-SDSA
Drill bits Aggressor SDS plus



RT-ADAP
Expanders SDS plus Roof System



RT-TD
Drill bits Roof System

R-WX-T SELF-DRILLING SCREWS FOR STEEL

Screw for trapezoidal steel sheet



FEATURES AND BENEFITS

- Hardened thread surface
- High quality anti-corrosion coating guarantees resistance of 15 Kesternich cycles
- Shape and type of the thread specially design to allow connecting to metal sheets
- The drill point is designed to provide a fast and hassle-free installation. Sharp point of the drill prevents movement of the surface of the fixture
- Reduced drilling point ensures optimal tightness and correct hole diameter in thin metal sheets.
- Pre-assembly with other components is possible before installation

APPLICATIONS

- Insulation layers on flat roofs together with a appropriate telescopic or steel washer

BASE MATERIALS

- Approved for use in:
 - Metal Sheet & Profiles



INSTALLATION GUIDE

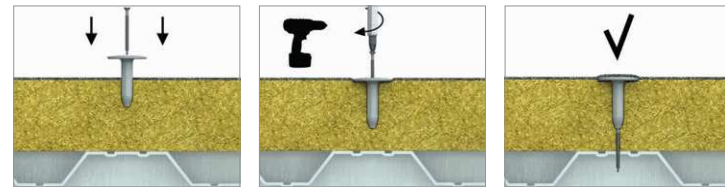

1. Select a suitable screw type for substrate
2. Lightly insert plastic sleeve into insulation material
3. Using drilling machine, drive the screw into substrate until fixing depth is reached

PRODUCT INFORMATION

Product Code	Plastic sleeve	
	Diameter	Length
	d [mm]	L [mm]
R-WX-48T050	4.8	50
R-WX-48T060	4.8	60
R-WX-48T070	4.8	70
R-WX-48T080	4.8	80
R-WX-48T100	4.8	100
R-WX-48T120	4.8	120
R-WX-48T140	4.8	140
R-WX-48T160	4.8	160
R-WX-48T180	4.8	180
R-WX-48T200	4.8	200
R-WX-48T240	4.8	240
R-WX-48T300	4.8	300

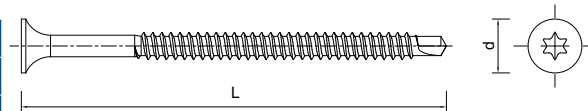

R-WX-T SELF-DRILLING SCREWS FOR STEEL (cont.)

INSTALLATION DATA

Size	Steel		
Screw diameter	d	[mm]	4.8
Hole diameter in substrate	d ₀	[mm]	-
Min. hole depth in substrate	h ₀	[mm]	-
Min. installation depth	h _{nom}	[mm]	-
Min. substrate thickness	h _{min}	[mm]	0.63
Min. spacing	s _{min}	[mm]	120
Min. edge distance	c _{min}	[mm]	30

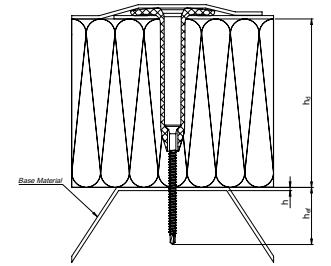

BASIC PERFORMANCE DATA

Substrate	Concrete C12/15	
Effective embedment depth h _{ef}	[mm]	0.75
MEAN ULTIMATE LOAD N _{Ru,m}		
GOK + WX	[kN]	1.42
CHARACTERISTIC LOAD N _{Rk}		
GOK + WX	[kN]	1.01
DESIGN LOAD N _{Rd}		
GOK + WX	[kN]	0.50
RECOMMENDED LOAD N _{rec}		
GOK + WX	[kN]	0.36

Design performance data

PULL OUT - SCREW FROM SUBSTRATE

Size	Steel				
Effective embedment depth h _{ef}	h _{ef}	[mm]	0.75	1	1.25
TENSION LOAD					
PULL-OUT FAILURE					
Characteristic resistance	V _{Rk,p}	[kN]	1.01	1.53	1.66
Design resistance	V _{Rd,p}	[kN]	0.50	0.76	0.83
PULL OUT -GOK SLEEVE					
Characteristic resistance	V _{Rk,p}	[kN]	2.45		
Design resistance	V _{Rd,p}	[kN]	1.23		

ASSOCIATED PRODUCTS



R-GOK
Telescopic sleeve with round plate



RT-SDSA
Drill bits Aggressor SDS plus



RT-ADAP
Expanders SDS plus Roof System



RT-TD
Drill bits Roof System

R-WO-T SCREWS FOR STEEL

Screw for trapezoidal steel sheet substrate; max thickness of 0.9mm, TX25 drive



FEATURES AND BENEFITS

- Hardened thread surface
- High quality anti-corrosion coating guarantees resistance of 15 Kesternich cycles
- Shape and type of the thread specially design to allow connecting to metal sheets and wood
- The drill point is designed to provide a fast and hassle-free installation. Sharp point of the drill prevents movement of the surface of the fixture
- Pre-assembly with other components is possible before installation

APPLICATIONS

- Insulation layers on flat roofs together with a appropriate telescopic or steel washer

BASE MATERIALS

- Approved for use in:
- Metal Sheet & Profiles
 - Timber
 - Chipboard
 - Oriented Strand Board



INSTALLATION GUIDE

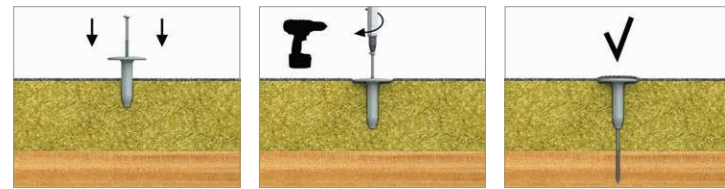

1. Lightly insert plastic sleeve into insulation material
2. Using drilling machine, drive the WO screw into substrate until fixing depth is reached

PRODUCT INFORMATION

Product Code	Plastic sleeve	
	Diameter	Length
	d [mm]	L [mm]
R-WO-48T060	4.8	60
R-WO-48T080	4.8	80
R-WO-48T100	4.8	100
R-WO-48T120	4.8	120
R-WO-48T140	4.8	140
R-WO-48T160	4.8	160
R-WO-48T180	4.8	180
R-WO-48T200	4.8	200
R-WO-48T240	4.8	240
R-WO-48T300	4.8	300

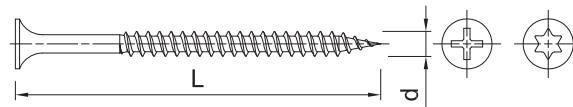

R-WO-T SCREWS FOR STEEL (cont.)

INSTALLATION DATA

Size	Steel	Timber, grade C24	Chipboard OSB
Screw diameter	d [mm]	4.8	4.8
Hole diameter in substrate	d ₀ [mm]	-	-
Min. hole depth in substrate	h ₀ [mm]	-	-
Min. installation depth	h _{nom} [mm]	-	18
Min. substrate thickness	h _{min} [mm]	0.5	18
Min. spacing	s _{min} [mm]	120	120
Min. edge distance	c _{min} [mm]	30	30

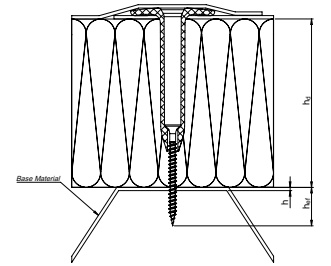

BASIC PERFORMANCE DATA

Substrate	Steel	Timber, grade C24	Chipboard OSB
Effective embedment depth h _{ef} [mm]	0.75	24.00	18.00
MEAN ULTIMATE LOAD N _{Ru,m}			
GOK + WO [kN]	1.66	2.53	2.33
CHARACTERISTIC LOAD N _{Rk}			
GOK + WO [kN]	0.93	1.45	1.08
DESIGN LOAD N _{rd}			
GOK + WO [kN]	0.46	0.72	0.75
RECOMMENDED LOAD N _{rec}			
GOK + WO [kN]	0.33	0.51	0.38

Design performance data

PULL OUT - SCREW FROM SUBSTRATE

Size	Steel	Timber, grade C24	Plywood	Chipboard OSB
Effective embedment depth h _{ef} [mm]	0.5, 0.63, 0.75	24	20	18
TENSION LOAD				
PULL-OUT FAILURE				
Characteristic resistance V _{Rk,p} [kN]	1.20	1.20	1.20	1.20
Design resistance V _{Rd,p} [kN]	1.22	1.22	1.22	1.22
PULL OUT - GOK SLEEVE				
Characteristic resistance V _{Rk,p} [kN]	5.03	9.15	14.50	21.08
Design resistance V _{Rd,p} [kN]	0.80	0.80	0.80	0.80

ASSOCIATED PRODUCTS



R-GOK
Telescopic sleeve with round plate



RT-SDSA
Drill bits Aggressor SDS plus



RT-ADAP
Expanders SDS plus Roof System



RT-TD
Drill bits Roof System

R-WW-T SCREWS FOR TIMBER

Shape and type of the thread specially designed for fixing to wood, TX25 drive

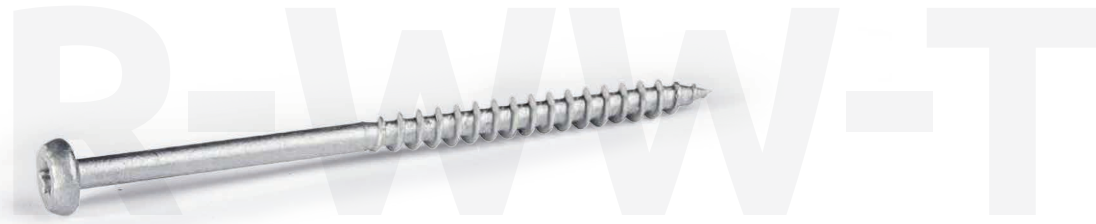

FEATURES AND BENEFITS

- Hardened thread surface
- High quality anti-corrosion coating guarantees resistance of 15 Kesternich cycles
- The shape and type of screw's thread is designed specifically for connecting to wood.
- The drill point is designed to provide a fast and hassle-free installation. Sharp point of the drill prevents movement of the surface of the fixture
- Pre-assembly with other components is possible before installation

APPLICATIONS

- Insulation materials in flat roof applications in conjunction with telescopic connector and steel washer

BASE MATERIALS

- Approved for use in:
- Timber
 - Plywood
 - Chipboard
 - Oriented Strand



INSTALLATION GUIDE

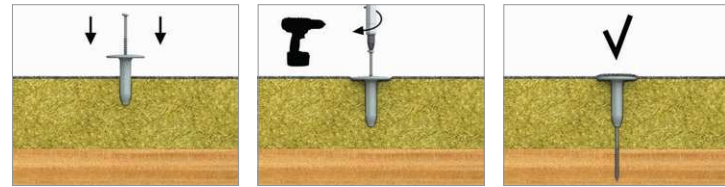

1. Lightly insert plastic sleeve into insulation material
2. Using drilling machine, drive the WW screw into substrate until fixing depth is reached

PRODUCT INFORMATION

Product Code	Plastic sleeve	
	Diameter	Length
	d [mm]	L [mm]
R-WW-50T25	5	25
R-WW-50T35	5	35
R-WW-50T45	5	45
R-WW-50T55	5	55
R-WW-50T75	5	75
R-WW-50T90	5	90

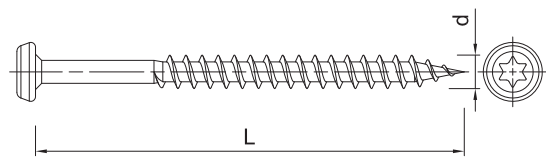

R-WW-T SCREWS FOR TIMBER (cont.)

INSTALLATION DATA

Size	Steel	Timber, grade C24	Chipboard OSB
Screw diameter	d [mm]	5	5
Hole diameter in substrate	d ₀ [mm]	-	-
Min. hole depth in substrate	h ₀ [mm]	-	-
Min. installation depth	h _{nom} [mm]	24	20
Min. substrate thickness	h _{min} [mm]	24	20
Min. spacing	s _{min} [mm]	120	120
Min. edge distance	c _{min} [mm]	30	30

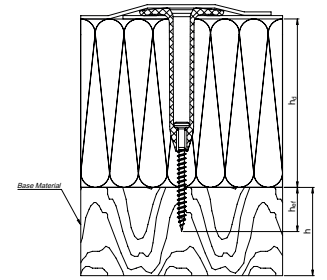

BASIC PERFORMANCE DATA

Substrate	Steel	Timber, grade C24	Chipboard OSB
Effective embedment depth h _{ef} [mm]	24.00	20.00	18.00
MEAN ULTIMATE LOAD N _{Ru,m}			
GOK + WO [kN]	1.84	1.84	1.84
CHARACTERISTIC LOAD N _{Rk}			
GOK + WO [kN]	1.66	1.66	1.32
DESIGN LOAD N _{rd}			
GOK + WO [kN]	0.83	0.83	0.66
RECOMMENDED LOAD N _{rec}			
GOK + WO [kN]	0.59	0.59	0.47

Design performance data

PULL OUT - SCREW FROM SUBSTRATE

Size	Steel	Timber, grade C24	Plywood	Chipboard OSB
Effective embedment depth h _{ef} [mm]	0.5	0.63	0.75	24
TENSION LOAD				
PULL-OUT FAILURE				
Characteristic resistance V _{Rk,p} [kN]	1.20	1.20	1.20	1.20
Design resistance V _{Rd,p} [kN]	1.22	1.22	1.22	1.22
PULL OUT - GOK SLEEVE				
Characteristic resistance V _{Rk,p} [kN]	5.03	9.15	14.50	21.08
Design resistance V _{Rd,p} [kN]	0.80	0.80	0.80	0.80

ASSOCIATED PRODUCTS



R-GOK
Telescopic sleeve with round plate



RT-SDSA
Drill bits Aggressor SDS plus



RT-ADAP
Expanders SDS plus Roof System



RT-TD
Drill bits Roof System

R-POK STEEL WASHERS

Shape and type of the thread specially designed for fixing to wood, TX25 drive



FEATURES AND BENEFITS

- Aluzinc coating for corrosion resistance
- Formed profile for added stiffness
- Ideal for rigid insulation

APPLICATIONS

- Mechanically fastened flexible roof waterproofing membrane

INSTALLATION GUIDE

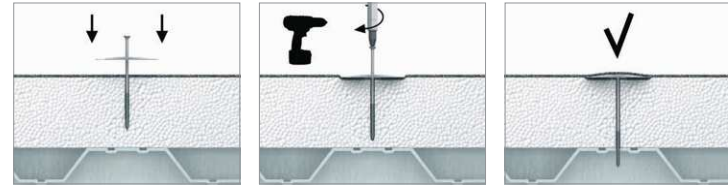

- Position POK washer on insulation and insert: WCS,WW screw
- Using drilling machine, drive the screw into substrate until fixing depth is reached

PRODUCT INFORMATION

Product Code	Aluminum washer			Fixture	
	Hole diameter	Plate diameter	Thickness	Min. thickness	Max. thickness
	d	D	t	t _{fix}	
[mm]					
R-POK-040-ALZN	2.5	40	0.7	45	265
R-POK-041-ALZN	7	40	0.7	45	265
R-POK-06-ALZN	6.5	76	0.7	-	-

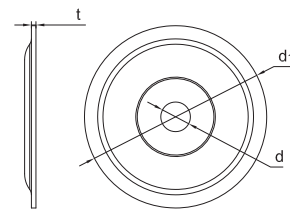

ASSOCIATED PRODUCTS



R-WBT

Screws for Concrete



R-WX-T

R-WX-T Self-drilling screws for steel



R-WO-T

R-WX-T Screws for steel



R-WW-T

R-WX-T Screws for timber

R-POW-05, R-POW-07 OVAL STEEL WASHERS

Steel washer with special form for roofing applications, for use with all types of roofing screws



FEATURES AND BENEFITS

- Deep shape of the washer in connection with WB double-threaded screw is the solution for installation of roofing membrane system to steel sheet
- Oval washer made of aluminum and zinc sheet, which ensures a very high resistance against corrosion

APPLICATIONS

- Mechanically fastened flexible roof waterproofing membrane

BASE MATERIALS

- Approved for use in:
- Metal Sheet & Profiles
 - Timber
 - Chipboard
 - Plywood
 - Concrete
 - Concrete Slab

INSTALLATION GUIDE



- Position POK washer on insulation and insert: WCS,WW screw
- Using drilling machine, drive the screw into substrate until fixing depth is reached

PRODUCT INFORMATION

Product Code	Aluminum washer				Fixture	
	Hole diameter	Lenght	Width	Thickness	Min. thickness	Max. thickness
	d	a	b	t	t _{fix}	
[mm]						
R-POW-05-ALZN	5	82	40	0.7	45	265
R-POW-07-ALZN	7	82	40	0.7	45	265

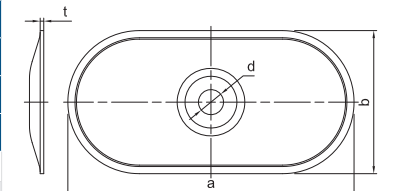

ASSOCIATED PRODUCTS



R-WBT

Screws for Concrete



R-WX-T

R-WX-T Self-drilling screws for steel



R-WO-T

R-WX-T Screws for steel



R-WW-T

R-WX-T Screws for timber

FIXING SELECTION ACCORDING TO INSULATION THICKNESS

[mm]	STEEL		CONCRETE		WOOD
	Rawplug code	Rawplug code	Rawplug code	Rawplug code	Rawplug code
60	R-GOK-035+R-WX-48T060	R-GOK-035+R-WO-48T060	R-GOK-035+R-WBT-61075	R-GOK-035+R-WO-48080+R-K08L40	R-GOK-035+R-WW-5075
80	R-GOK-065+R-WX-48T050	R-GOK-065+R-WO-48T060	R-GOK-035+R-WBT-61090	R-GOK-065+R-WO-48080+R-K08L40	R-GOK-065+R-WW-5055
100	R-GOK-085+R-WX-48T050	R-GOK-085+R-WO-48T060	R-GOK-085+R-WBT-61050	R-GOK-085+R-WO-48080+R-K08L40	R-GOK-085+R-WW-5055
120	R-GOK-105+R-WX-48T050	R-GOK-105+R-WO-48T060	R-GOK-105+R-WBT-61050	R-GOK-105+R-WO-48080+R-K08L40	R-GOK-105+R-WW-5055
140	R-GOK-105+R-WX-48T070	R-GOK-105+R-WO-48T080	R-GOK-105+R-WBT-61090	R-GOK-135+R-WO-48080+R-K08L40	R-GOK-105+R-WW-5075
160	R-GOK-135+R-WX-48T060	R-GOK-135+R-WO-48T060	R-GOK-135+R-WBT-61075	R-GOK-135+R-WO-48080+R-K08L40	R-GOK-135+R-WW-5075
180	R-GOK-165+R-WX-48T050	R-GOK-165+R-WO-48T060	R-GOK-135+R-WBT-61090	R-GOK-165+R-WO-48080+R-K08L40	R-GOK-165+R-WW-5055
200	R-GOK-185+R-WX-48T050	R-GOK-185+R-WO-48T060	R-GOK-165+R-WBT-61090	R-GOK-185+R-WO-48080+R-K08L40	R-GOK-185+R-WW-5055
220	R-GOK-185+R-WX-48T070	R-GOK-185+R-WO-48T080	R-GOK-185+R-WBT-61090	R-GOK-185+R-WO-48100+R-K08L40	R-GOK-185+R-WW-5075
240	R-GOK-225+R-WX-48T050	R-GOK-225+R-WO-48T060	R-GOK-035+R-WBT-61075	R-GOK-225+R-WO-48080+R-K08L40	R-GOK-225+R-WW-5055
260	R-GOK-225+R-WX-48T070	R-GOK-225+R-WO-48T080	R-GOK-225+R-WBT-61090	R-GOK-225+R-WO-48100+R-K08L40	R-GOK-225+R-WW-5075
280	R-GOK-255+R-WX-48T060	R-GOK-255+R-WO-48T060	R-GOK-255+R-WBT-61075	R-GOK-255+R-WO-48080+R-K08L40	R-GOK-255+R-WW-5075
300	R-GOK-285+R-WX-48T050	R-GOK-285+R-WO-48T060	R-GOK-255+R-WBT-61090	R-GOK-285+R-WO-48080+R-K08L40	R-GOK-285+R-WW-5055
320	R-GOK-285+R-WX-48T070	R-GOK-285+R-WO-48T080	R-GOK-285+R-WBT-61090	R-GOK-285+R-WO-48100+R-K08L40	R-GOK-285+R-WW-5075
340	R-GOK-325+R-WX-48T050	R-GOK-325+R-WO-48T060	R-GOK-285+R-WBT-61100	R-GOK-325+R-WO-48080+R-K08L40	R-GOK-325+R-WW-5055
360	R-GOK-325+R-WX-48T070	R-GOK-325+R-WO-48T080	R-GOK-325+R-WBT-61090	R-GOK-325+R-WO-48100+R-K08L40	R-GOK-325+R-WW-5075
380	R-GOK-325+R-WX-48T100	R-GOK-325+R-WO-48T100	R-GOK-325+R-WBT-61100	R-GOK-325+R-WO-48120+R-K08L40	R-GOK-325+R-WW-5090
400	R-GOK-325+R-WX-48T120	R-GOK-325+R-WO-48T120	R-GOK-325+R-WBT-61120	R-GOK-325+R-WO-48120+R-K08L40	-
420	R-GOK-325+R-WX-48T140	R-GOK-325+R-WO-48T140	R-GOK-325+R-WBT-61140	R-GOK-325+R-WO-48140+R-K08L40	-
440	R-GOK-425+R-WX-48T050	R-GOK-425+R-WO-48T060	R-GOK-385+R-WBT-61100	R-GOK-425+R-WO-48080+R-K08L40	R-GOK-425+R-WW-5055
460	R-GOK-425+R-WX-48T070	R-GOK-425+R-WO-48T080	R-GOK-425+R-WBT-61090	R-GOK-425+R-WO-48100+R-K08L40	R-GOK-425+R-WW-5075
480	R-GOK-425+R-WX-48T100	R-GOK-425+R-WO-48T100	R-GOK-425+R-WBT-61100	R-GOK-425+R-WO-48120+R-K08L40	R-GOK-425+R-WW-5090
500	R-GOK-425+R-WX-48T120	R-GOK-425+R-WO-48T120	R-GOK-425+R-WBT-61120	R-GOK-425+R-WO-48140+R-K08L40	R-GOK-425+R-WW-5120
520	R-GOK-425+R-WX-48T140	R-GOK-425+R-WO-48T140	R-GOK-425+R-WBT-61140	R-GOK-425+R-WO-48160+R-K08L40	R-GOK-425+R-WW-5140
540	R-GOK-525+R-WX-48T050	R-GOK-525+R-WO-48T060	R-GOK-525+R-WBT-61075	R-GOK-525+R-WO-48080+R-K08L40	R-GOK-525+R-WW-5055
560	R-GOK-525+R-WX-48T070	R-GOK-525+R-WO-48T080	R-GOK-525+R-WBT-61090	R-GOK-525+R-WO-48100+R-K08L40	R-GOK-525+R-WW-5075
580	R-GOK-525+R-WX-48T100	R-GOK-525+R-WO-48T100	R-GOK-525+R-WBT-61100	R-GOK-525+R-WO-48120+R-K08L40	R-GOK-525+R-WW-5090
600	R-GOK-525+R-WX-48T120	R-GOK-525+R-WO-48T120	R-GOK-525+R-WBT-61120	R-GOK-525+R-WO-48140+R-K08L40	R-GOK-525+R-WW-5120
620	R-GOK-525+R-WX-48T140	R-GOK-525+R-WO-48T140	R-GOK-525+R-WBT-61140	R-GOK-525+R-WO-48160+R-K08L40	R-GOK-525+R-WW-5140
640	R-GOK-625+R-WX-48T050	R-GOK-625+R-WO-48T060	R-GOK-625+R-WBT-61075	R-GOK-625+R-WO-48080+R-K08L40	R-GOK-625+R-WW-5055
660	R-GOK-625+R-WX-48T070	R-GOK-625+R-WO-48T080	R-GOK-625+R-WBT-61090	R-GOK-625+R-WO-48100+R-K08L40	R-GOK-625+R-WW-5075
680	R-GOK-625+R-WX-48T100	R-GOK-625+R-WO-48T100	R-GOK-625+R-WBT-61100	R-GOK-625+R-WO-48120+R-K08L40	R-GOK-625+R-WW-5090
700	R-GOK-625+R-WX-48T120	R-GOK-625+R-WO-48T120	R-GOK-625+R-WBT-61120	R-GOK-625+R-WO-48140+R-K08L40	R-GOK-625+R-WW-5120
720	R-GOK-625+R-WX-48T140	R-GOK-625+R-WO-48T140	R-GOK-625+R-WBT-61140	R-GOK-625+R-WO-48160+R-K08L40	R-GOK-625+R-WW-5140
740	R-GOK-725+R-WX-48T050	R-GOK-755+R-WO-48T060	R-GOK-725+R-WBT-61075	R-GOK-725+R-WO-48080+R-K08L40	R-GOK-725+R-WW-5055
760	R-GOK-725+R-WX-48T070	R-GOK-725+R-WO-48T080	R-GOK-725+R-WBT-61090	R-GOK-725+R-WO-48100+R-K08L40	R-GOK-725+R-WW-5075
780	R-GOK-725+R-WX-48T100	R-GOK-725+R-WO-48T100	R-GOK-725+R-WBT-61100	R-GOK-725+R-WO-48120+R-K08L40	R-GOK-725+R-WW-5090
800	R-GOK-725+R-WX-48T120	R-GOK-725+R-WO-48T120	R-GOK-725+R-WBT-61120	R-GOK-725+R-WO-48140+R-K08L40	R-GOK-725+R-WW-5120
820	R-GOK-725+R-WX-48T140	R-GOK-725+R-WO-48T140	R-GOK-725+R-WBT-61140	R-GOK-725+R-WO-48160+R-K08L40	R-GOK-725+R-WW-5140
840	R-GOK-725+R-WX-48T160	R-GOK-725+R-WO-48T160	R-GOK-725+R-WBT-61160	R-GOK-725+R-WO-48180+R-K08L40	R-GOK-725+R-WW-5160
860	R-GOK-725+R-WX-48T180	R-GOK-725+R-WO-48T180	R-GOK-725+R-WBT-61180	R-GOK-725+R-WO-48200+R-K08L40	R-GOK-725+R-WW-5180
880	R-GOK-725+R-WX-48T200	R-GOK-725+R-WO-48T200	R-GOK-725+R-WBT-61200	R-GOK-725+R-WO-48240+R-K08L40	R-GOK-725+R-WW-5200
900	R-GOK-725+R-WX-48T240	R-GOK-725+R-WO-48T240	R-GOK-725+R-WBT-61240	R-GOK-725+R-WO-48240+R-K08L40	R-GOK-725+R-WW-5240
920	R-GOK-725+R-WX-48T240	R-GOK-725+R-WO-48T240	R-GOK-725+R-WBT-61240	R-GOK-725+R-WO-48300+R-K08L40	R-GOK-725+R-WW-5240
940	R-GOK-725+R-WX-48T240	R-GOK-725+R-WO-48T240	R-GOK-725+R-WBT-61300	R-GOK-725+R-WO-48300+R-K08L40	R-GOK-725+R-WW-5300
960	R-GOK-725+R-WX-48T300	R-GOK-725+R-WO-48T300	R-GOK-725+R-WBT-61300	R-GOK-725+R-WO-48300+R-K08L40	R-GOK-725+R-WW-5300
980	R-GOK-725+R-WX-48T300	R-GOK-725+R-WO-48T300	R-GOK-725+R-WBT-61300	-	R-GOK-725+R-WW-5300
990	R-GOK-725+R-WX-48T300	R-GOK-725+R-WO-48T300	-	-	R-GOK-725+R-WW-5300

More from Rawlplug

Efficacy in the hardest conditions

We are proud to present innovative fixing from the **Bonded Anchors and Mechanical Anchors** group designed for the heavy loads demanded by industrial construction. Among our products you will find unique solutions to enable you to achieve maximal amounts with any kind of substrate. Knowledge backed-up with experience guarantees the effectiveness of our fixings and the success of your investment.

Durability and versatility

Our wide range of expansion plugs made of synthetic materials and metal, for low and medium loads, have been used for years for both industrial and residential construction. Incredibly durable FF1 from frame fixings group, universal in use 4ALL and UNO Plug, no. 1 on the UK market, are leading products of RAWPLUG's offer in the field of **Lightweight Fixings**, designed with every substrate in mind.

Innovations in Energy Saving construction

As a leading producer of façade insulation fixings we would like to present to you our wide array of products used in energy saving constructions. The Reliability and simplicity of our solutions combined with their ease of installation make them the most popular and desired by professionals. We invite you to familiarize yourselves with our offer for **Façade Insulations Fixings**.

Excellent resistance for high loads

Thanks to our close cooperation with roof covering product producers, and our insight into the needs of investment contractors, our **Roofing Insulations Fixings** are one of the most popular among European roof fixing system producers. We invite cooperation from engineers, architects, and roof works contractors. And encourage you to try out our calculation software "ROOFIX" today.

Guarantee of lasting quality

Thanks to our constant monitoring of the production of assortments from our **Foams, Sealants and Adhesives** range we guarantee the constant and repeatable quality of our products. Their wide range of application possibilities and high efficiency has enabled us to rank among the top 5 of companies in the construction chemistry industry for years.

Maximal weather resistance

Rawlplug's **Fasteners** guarantee reliability of connections and maximal weather resistance. Our products, thanks to the use of appropriate materials and adoption of modern anticorrosion coating, pass even the hardest tests, matching the expectations of the most demanding clients. In our rich offer of screws characterized by extraordinary ease of installation, one may find perfect kind of connection for any kind of material and substrate.

Save time and minimize costs

In our offer of **Direct Fastening Systems** you may find, among others, highly effective pneumatically and gas powered nailers with accessories, compressors and an innovative and ergonomic rebar tier. We invite you to familiarize yourselves with the capabilities of Rawlplug's tools, which can significantly increase the comfort and effectiveness of work at any construction site.

Maximal effect of optimal offer

In order to ease the application and proper use and installation of our products, we supplement the our assortment of fixings with a precisely composed offer of **Power Tool Accessories**. They include, among others, European-made drills of the highest quality, as confirmed with a **Sichersafe** certificate. We invite you to familiarize yourselves with our offer of accessories for professional installation techniques of the Rawlplug® brand.

Ergonomics for construction and at home

We offer high-quality **Stapling, Tacking and Gluing** tools that are recommended for both professionals and home DIY. Rawlplug's stapling tools are especially intended for construction, finishing works and repairs while our hot-melt adhesive system includes a new line of glue guns and glues for a wide range of applications - all of which are exceptionally easy to use and provide maximum efficiency and a high degree of flexibility for routine work

Unique and exclusive exposition

Rawlplug **POS Essential Offer** it is a unique and complete solution designed for product exposition in building wholesale and retail stores. The POS system is based on easily configurable rack components enhanced with expansive information elements and additional decorations, as well as a combination of individual packages in form of innovative Rawlplug Bag and cutting-edge cardboard boxes.

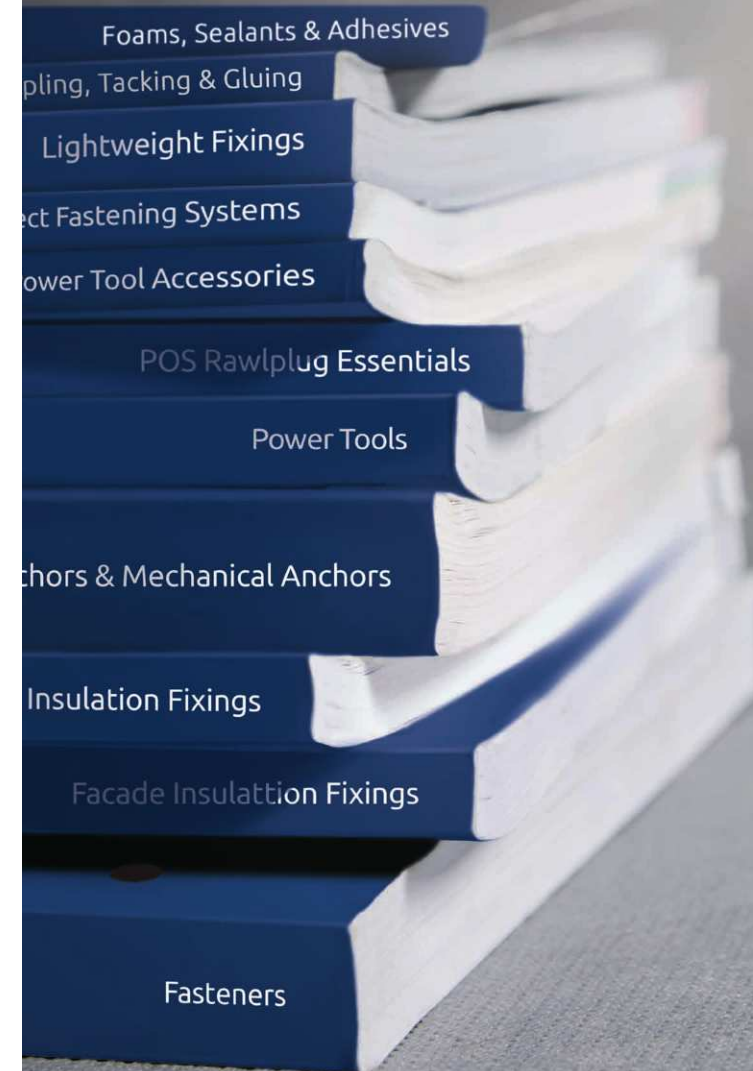



RAWLPLUG®

AUSTRALIA

Rawlplug Australia
255 Whitehorse Road
Suite 7, Level 1
Balwyn, Vic 3103
Tel: + 61 428 647 745
Email: craig.salmon@rawlplug.com
Web: www.rawlplug.com

GERMANY

Koelner Deutschland GmbH
Gmünder Str. 65
73614 Schorndorf
Tel: +49 (0) 7181 977 72-0
Email: info@koelner-befestigung.de
Web: www.rawlplug.com

ITALY

Rawlplug Italy S.r.l.
Via Privata Euro Industrie n. 4/6
20052 - Vignate (MI)
Tel: +39 02 50309590
Email: informazioni@rawlplug.com
Web: www.rawlplug.it

RUSSIA

Koelner Trading KLD LLC
ul. Dzerzhinskogo 219
236034 Kaliningrad
Tel: + 7 (4012) 65 85 75
Email: info@koelner-trading.ru
Web: www.koelner-trading.ru

SWEDEN

Rawl Scandinavia AB
Baumansgatan 4
593 32 Västervik
Tel: +46(0)490 30660
Email: info@rawlplug.se
Web: www.rawlplug.se

UNITED ARAB EMIRATES

Rawlplug Middle East FZE
P.O. Box 261024 Dubai, UAE
Warehouse No.RA08BC01
Tel: + 971 (4) 8839 501
Email: dubai@rawlplug.co.uk
Web: www.rawl.ae

CHINA

Rawlplug Shanghai Trading Co., Ltd.
Room B209, No. 139 Fanghua Road,
Pudong, Shanghai
P.R. China Post code 201204
Tel: +86 189 1882 8527
Email: Jennifer.Song@rawlplug.com
Web: www.rawlplug.com

HUNGARY

Koelner Hungária Kft
Jedlik Anyos út. 34
2330 Dunaharaszti
Tel: + 36 (24) 520 400
Email: info@koelner.hu
Web: www.koelner.hu

LITHUANIA

UAB Koelner Vilnius
Žarijų g. 2
LT-02300, Vilnius
Tel: + 370 (5) 2324 862
Email: koelner@koelner.lt
Web: www.koelner.lt

SINGAPORE

Rawlplug Singapore Pte. Ltd.
Blk 302, #04-11, 25B Loyang Crescent
Loyang Offshore Supply Base
Singapore 506817
Tel: + 65 9078 5220
Email: jacek.nowicki@rawlplug.com.sg
Web: www.rawlplug.com

THAILAND

Rawlplug (Thailand) Limited
Address: 888/43 Moo 9
T.Bangpla, A.Bangplee
Samutprakarn 10540
Thailand
Tel.: +662 731 4788
Web: www.rawlplug.com

UNITED KINGDOM

Rawlplug Ltd
Skibo Drive
Thornliebank Industrial Estate
Glasgow G46 8JR
Tel: + 44 (0) 141 638 7961
Fax: + 44 (0) 141 638 7397
Email: rawlinfo@rawlplug.co.uk
Web: www.rawlplug.co.uk

CZECH REPUBLIC

Koelner CZ s.r.o
Palackého 1154/76A
702 00 Ostrava-Prívóz
Tel: + 420 596 636 A 397
Email: objednavky@rawlplug.cz
Web: www.koelner.cz
Web: www.rawlplug.cz

INDIA

Rawl India Services Private Limited
Head Office: +91 08 4302 2234
#29, Prestige Meridian - I 503,
M.G.Road, Bangalore – 560001
Karnataka, India
Tel: 91 – 7356209642
Email: india@rawlplug.com
Web: rawlplug.com

POLAND

Rawlplug S.A.
ul. Kwidzyńska 6
51-416 Wrocław
Tel: +48 (71) 32 60 100
Fax: +48 (71) 37 26 111
Email: info@rawlplug.com
Web: www.rawlplug.com

SLOVAKIA

Koelner Slovakia s.r.o.
Jánošíkova 1
010 01 Žilina
Tel: + 421 415 003 900
Email: objednavky@rawlplug.sk
Web: www.koelner.sk
Web: www.rawlplug.sk

TURKEY

Rawlplug Turkey
Insaat Malzemeleri LTD. STI.
FSM mah. Poligon cad. Buyaka 2
sitisi 3 blok NO8C/1
Umraniye /I stanbul
Tel.: +90 5449 300 261
Web: www.rawlplug.com

UNITED STATES OF AMERICA

Rawlplug Inc.
225 West Washington Ste. 2600
Chicago IL 60605
Tel.: +1 312 940 5102
Web: www.rawlplug.us

FRANCE

RAWLPLUG France
Bâtiment DC6, ZAC de la Feuchère
16, rue Jean Mermoz
77290 Compans
Tel: + 33 (0) 1 6021 5020
Email: rawl@rawlplug.com
Web: www.rawlplug.fr

IRELAND

Rawlplug Ireland Ltd
Unit 10 Donore Business Park
Donore Road Drogheda
Co Louth A92 C522
Tel: + 353 (0) 41 9844 338
Email: sales@rawlplug.ie
Web: www.rawlplug.ie

PORTUGAL

Rawlplug Lda
Business Park Maia
Rua Eng Frederico Ulrich 3110, B1
4470-605 Maia, Portugal
Email: pt.clientes@rawlplug.com
Tel: +351 221 174 633
Web: www.rawlplug.pt

SPAIN

Rawlplug Lda
Business Park Maia
Rua Eng Frederico Ulrich 3110, B1
4470-605 Maia, Portugal
Email: es.clientes@rawlplug.com
Tel: +34 653 782 215
Web: www.rawlplug.es

UKRAINE

Koelner Ukraine LLC
Lvivska Bichna, 6
Sokilnyky
Pustomyty Dstr., Lviv Reg. 81130
Tel.: + 380 (32) 2440 744
Email: koelner@koelner.ua
Web: www.koelner.ua

VIETNAM

**Factory A_18_4_B, C, D, E,
Lot A_18_CN**
Bau Bang Industrial Park, Lai Uyen Town
Bau Bang District,
Binh Duong Province
Vietnam, 75700

