

**fischer** 

# Catalogue Façade Systems



**„Innovative strength and technological competence strengthen our position at Market.“**





# Foreword

## Dear business partners,

ventilated curtain walls (VHF) combine a stylish appearance with modern technology that meets current requirements for contemporary thermal insulation. We offer innovative and high-quality complete solutions from a single source for the secure fixing of VHF. In addition to technical and economic advantages, our façade systems score points with their great freedom of design.

Thanks to undercut technology, our Zykon FZP II plate anchors exceed the holding forces and performance characteristics of conventional fixing solutions many times over. Thus, façade panels with small thicknesses and large formats can be installed. Different designs are suitable for almost all cladding materials. The undercut technology also ensures a joint pattern without visible fastening elements. We also have the right solutions for replacing panels, fixing in reveals or compensating for tolerances.

Our optimally coordinated complete system with panel anchors, suitable subframe solutions and anchor technology as well as sophisticated drilling technology speeds up and simplifies installation, shortens the construction time and consequently reduces your project costs.

With our comprehensive range of services, we support both planners and contractors worldwide in all construction phases – from consulting and dimensioning, approval procedures, installation and logistics planning to on-site instruction.

We are looking forward to the mutual exchange of ideas and the continued close cooperation with you. Your suggestions are very valuable to us in order to continuously improve our products, processes and services. Feel free to contact us at any time with your questions and projects.

Have fun discovering our latest façade systems!

**Christian Knoll**  
Managing Director fischer SystemTec



**„Whoever chooses fischer receives more than a range of safe products. The aim is to always develop the best solutions for our customers across the globe.“**

Besides the innovative products, this predominantly concerns support that is focused on the customer, and services designed to improve customer benefit.

## A brand and its promise to perform.

### Continuous improvement

The fischer ProzessSystem (fPS) we ensure that we are adapting and optimising our processes in line with customer requirements in a flexible manner and on a continuous basis. Thus we are glad having been awarded with the 1. place “Excellence in Operations” within the challenging contest “Factory of the Year”.



Award 2015  
Excellence in  
Operations

### Safety that connects. Decisive quality

We don't make any compromises when it comes to the safety of our products. A whole host of our products are distinguished by comprehensive, up-to-date and international approvals. The fischer product range is well-positioned in all sectors of fixing technology – Steel, Nylon and Chemical fixings. In award-winning quality which continues to impress both professional clients and private customers with equal measure.



International approvals characterise many of our products.

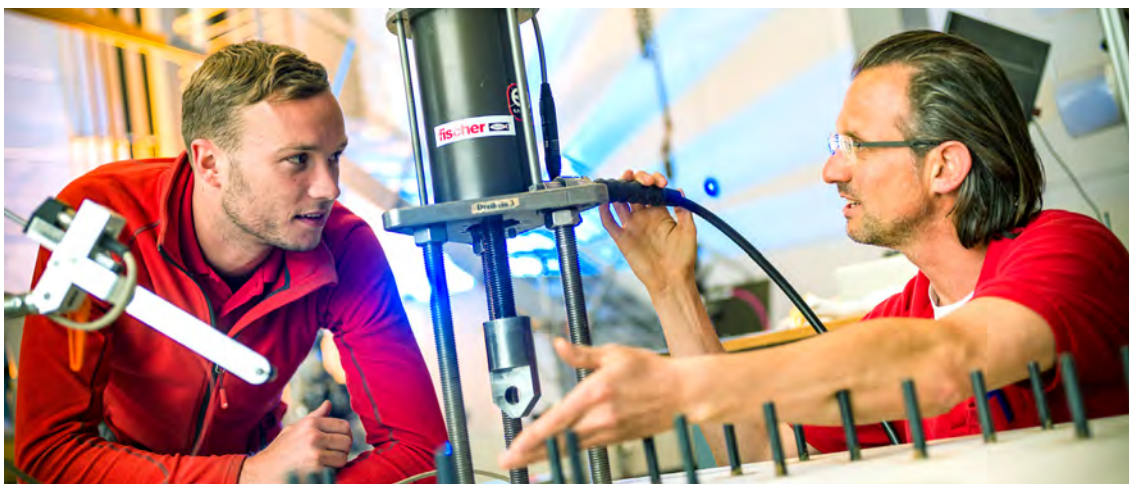





### Always on the pulse of time

At fischer, innovation is more than just a sum of the patents. We are open to new things and are prepared for change – always with the aim of offering our customers the greatest possible benefits. Over the years, our own development and production sites have been developing numerous fixing solutions for the most wide-ranging applications. Be it new production procedures or materials, such as renewable raw materials: We are carrying out the research for your safety and will continue to do so in the future. This gives us such great flexibility that we can even develop tailor-made customer solutions. This power to innovate has seen fischer become market leader in anchor technology and the fixing industry.

### Our service to you

We are a reliable partner, one that will stand at your side and address your individual requirements with advice and action:

- Our products range from chemical systems to steel anchors through to plastic anchors.
- Competence and innovation through own research, development and production.
- Global presence and active sales service in over 100 countries.
- Qualified technical consulting for economical and compliant fastening solutions. Also on-site at the construction site requested.
- Training sessions, some with accreditation, at your premises or at the fischer academy.
- Design and construction software for demanding applications.

### We take responsibility

Our active environment management policy means that we are helping to maintain an intact environment for our generation and for those that follow. The environment management policy at the Tumlingen site has been certified in line with DIN EN ISO 14001.

It fills us with particular pride that in 2020 we have received the most important and largest award in Europe in the field of sustainability: the German Sustainability Award - category large companies. This was in recognition of our holistic approach and the strategic anchoring of our sustainability management. With our greenline products we have launched the first range of fixings on the market that is based on renewable raw materials to more than 50%.



Greenline assortment based on 50% regrowing raw materials



German Sustainability Award



# About fischer façade systems:

## 1. Undercut technology

The fischer undercut technology contains several compatible components whose correct combination is necessary for the secure fixing of the façade panels:

<b>fischer Zykon panel anchor FZP II</b>	<b>19</b>
<b>Drilling technique</b>	
Undercut drill bits	61
fischer drilling machines	53
Accessories for drilling with CNC machines	59
<b>Testing and measuring tools for quality assurance of undercut holes</b>	<b>65</b>
<b>Setting tools for the installation of undercut anchors</b>	<b>69</b>
<b>Installation accessories for installing the undercut anchors and clasps</b>	<b>81</b>

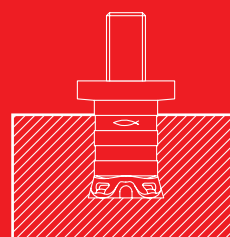

## 2. Subframe systems

The subframe systems consists of different components for load bearing and compensation of building substrate tolerances. Therefore following system components are necessary:

<b>Wall holders</b>	<b>79</b>
<b>Vertical profiles</b>	<b>77</b>
<b>Horizontal profiles</b>	<b>74</b>
<b>Clasps</b>	<b>75</b>
<b>Fixing elements</b>	<b>89</b>
<b>Installation accessories</b>	<b>81</b>

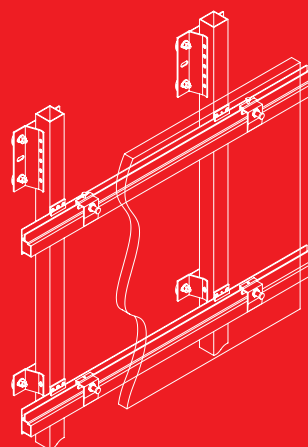



# Façade cross-section and system advantages.

## System overview based on a façade cross-section:

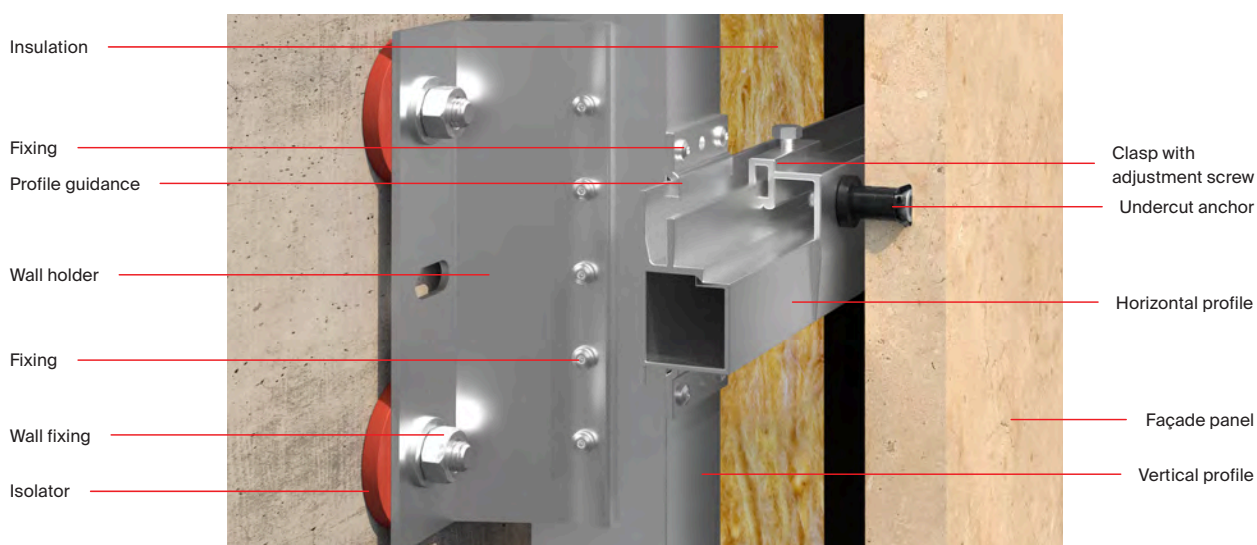

## Advantages fischer façade system:



On-site support



Technology leadership beyond the state-of-the-art



Fast supply and installation of the system



Global availability and supply of a complete system from a single source



Cost efficiency of the overall system with fischer quality



Approved and third-party certified systems and in-house test laboratory





FRAC



# Innovations that inspire professionals.

---

<b>Introduction</b>	<b>11</b>	<i>chapter</i>	<b>1</b>
<b>Zykon panel anchor FZP II</b>	<b>19</b>	<i>chapter</i>	<b>2</b>
<b>Machine technology and drill bits</b>	<b>49</b>	<i>chapter</i>	<b>3</b>
<b>Subframe</b>	<b>71</b>	<i>chapter</i>	<b>4</b>
<b>General fixing products and accessories</b>	<b>89</b>	<i>chapter</i>	<b>5</b>
<b>Basics</b>	<b>105</b>	<i>chapter</i>	<b>6</b>
<b>Service</b>	<b>111</b>	<i>chapter</i>	<b>7</b>

---





# 1

## Introduction

---

Rainscreen façade	12
Requirements for façade systems	14
fischer façade systems	17

---

# 1 Functional principle rainscreen façades.

## Rainscreen façades

A rainscreen façade is a ventilated double-layer cladding system which structurally separates the weather protection and insulation functions.

Based on many advantages compared to sealed façade systems rainscreen systems have become very popular nowadays.

The façade system consists of the cladding material, the rear ventilation cavity, the insulation material and the subframe system, which is the structural connection between the façade cladding material and the building substrate.

Besides the aesthetic advantages there are also functional and safety benefits, which include the rear ventilation cavity and non-combustible insulation materials. These systems are less susceptible to damage than other façade systems and provide a wide freedom of design. In addition, fire, noise and lightning protection requirements can be implemented.

fischer offers innovative, high-quality overall façade systems for rainscreen façades. Besides functional and economical advantages, the fischer façade systems provide above all an outstanding architectural creative scope.

fischer façade systems are perfectly matched complete systems with many advantages:

- Long system life times
- Quick and easy installation
- Tested and approved single components
- Great architectural freedom of design
- Very low maintenance intervals
- Low maintenance costs
- Efficient thermal solution
- Shortened construction times
- Etc.

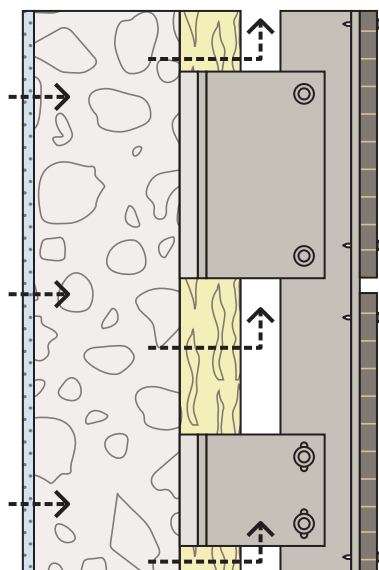

Functional principle rainscreen façade with system components





Office building · Venlo · Netherlands

# Freedom of design – fixed securely.

## Requirements for modern façades are:

- A visually impressive design
- Being technically state-of-the-art
- Economic efficiency during installation and over the entire life cycle

Whether in the construction or fixing of complete façade systems, whether in the installation of windows, the attachment of ETICS systems or in insulating, sealing and foaming, let us convince you of our products and their possible applications.

## fischer offers economical and innovative solutions for a wide range of façade applications:

- Heavy duty fixings in concrete
- Bespoke solutions and systems for a wide range of building materials
- Insulation plugs for ETICS
- Façade panel anchors
- Subframe systems
- Foams and sealants

## Provide your projects the stability they deserve:

fischer façade systems offer architects and planners innovative, high-quality full façade systems for rain-screen façades. Besides functional and economical advantages, the fischer façade systems provide above all an outstanding architectural creative scope.

## fischer goes beyond the state of the art by offering the following benefits:

- Subframe systems for all different cladding materials
- Flexible system for concealed applications
- Fast and uncomplicated installation reduces costs for the whole façade
- Complies with low and zero energy building standards
- Project-specific training, consultation and product solutions
- Global support by local representatives
- Experience in façade systems for 35 years
- Complete façade system supplied out of one hand
- ETA and CE approved



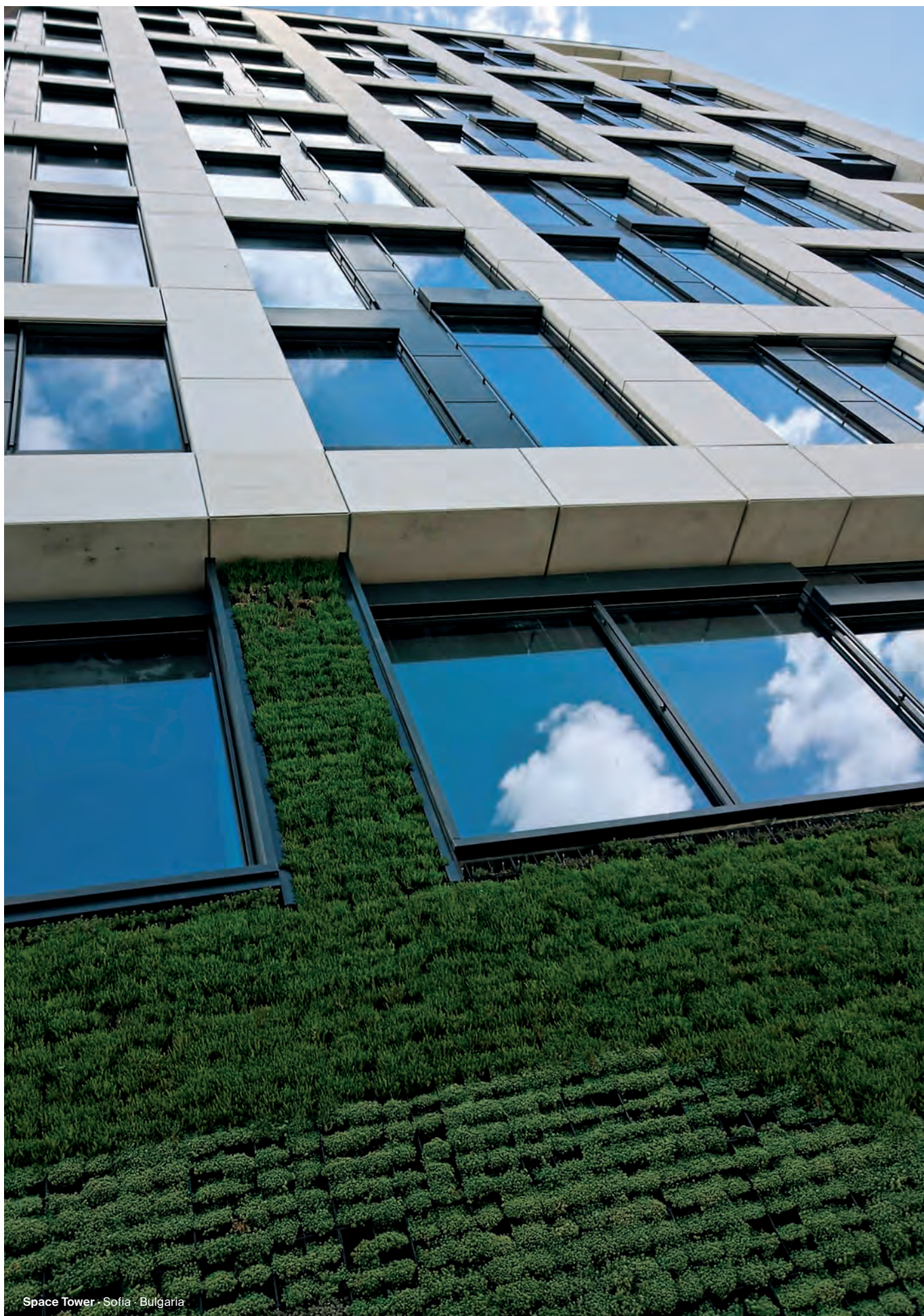

Space Tower · Sofia · Bulgaria





Cahir Castle · Tipperary · Ireland



# Why façade systems from fischer are the right choice.

## Choosing fischer

fischer is one of the most recognized brands in the world. We are a German-based family owned business with headquarter located in Waldachtal, in Germany's Northern Black Forest. fischer specializes in innovative chemical, steel and nylon anchoring systems for the construction industry. Our products range from small nylon anchors to advanced façade systems.

We're committed to developing the best solutions possible for our customers across the globe. This means we're committed to every aspect of quality, design and safety.

## Innovative strength

At fischer, innovation is more than just a sum of patents. We are always open to new things and are prepared for change, with the aim of offering our customers the greatest possible benefits. Over the years, our own development and production sites have been creating numerous fixing solutions for the widest range of applications. This has contributed to our product range having more than 14,000 anchors and solutions and more than 7,000 patents.

## Quality you can rely on

We do not compromise when it comes to safety. We test and certify our products to comply with international approvals and certifications. As leaders in steel, nylon and chemical fastening, we develop and provide impressive, award-winning solutions that support a variety of applications.

## The fischer façade systems are not limited to innovative system solutions - they are just starting here:

As fixing specialists we offer architects, planners and craftsmen full support from the planning phase through static calculations to just-in-time delivery to the construction site.

The provision of planning software and instruction for installers are also part of the service, as is advising on the selection of the right systems.

## The service offers for fischer façade systems at a glance

- Application technology services
- Determination of pull out loads and preparation of structural pre-calculations
- Advice on the selection of the right system components
- Support for architects, designers, structural engineers and contractors in all phases of their construction projects
- Support with licensing procedures
- Demonstration and instruction by our trained employees
- Services for machines
- Worldwide and local representatives
- fischer is a member of the professional association: Fachverband Baustoffe und Bauteile für vorgehängte hinterlüftete Fassaden e.V.



Downtown - Auckland - New Zealand











# 2

## Zykon-Panel anchor FZP II



### ZYKON-PANEL ANCHOR FOR NATURAL STONE

---

Zykon-Panel anchor FZP II A4	22	
Zykon-Panel anchor FZP II Carbon	24	
Zykon-Panel anchor FZP II SO AL	26	
Zykon-Panel anchor FZP II SO Carbon	28	
Zykon-Panel anchor FZP II VS	30	
Zykon-Panel anchor FZP II SH	32	
Zykon-Panel anchor FZP II M8i	34	
Zykon-Panel anchor FZP II M6i	36	



### ZYKON PANEL ANCHOR FOR THIN FAÇADE PANELS

---

Zykon-Panel anchor FZP II-T Tergo+	38	
Zykon-Panel anchor FZP II-T PA	40	
Zykon-Panel anchor FZP II-T D40	42	

### ZYKON-PANEL ANCHOR FOR SAFETY GLASS

---

Zykon-Glas point fixing FZP G-Z ESG	44	
Zykon-Glas point fixing FZP G-Z VSG	46	

---

# Differences in materiality.

## Naturally Stone.

Natural stone is a very sustainable building material as stones are natural materials, which may be sourced globally. The façade panel thicknesses range from 20 mm to 60 mm. fischer Zykon panel anchors can be used from a panel thickness of 20 mm. In addition, tolerances in panel flatness can be accommodated with

our stand-off anchors. With 35 years of experience, fischer provides support with material testing for the assessment of design resistances.



### The fischer natural stone anchors:

- FZP II A4
- FZP II Carbon
- FZP II SO AL
- FZP II SO Carbon
- FZP II VS
- FZP II SH
- FZP II M8i
- FZP II M6i

## Artificial ceramics.

Ceramic tiles are artificial materials. Typical for this type of cladding material is a wide range of colours and surface textures.

The thickness of the façade panels range from 8 mm to 20 mm. The fischer Zykon panel anchors can be used

from a thickness of 10 mm. The large disc of the anchor prevents a misalignment of the anchor when the ceramic panel has ribs on the back face.



### The fischer ceramic anchor:

- FZP II T D40



### Thin panel materials.

The most well-known examples of thin panel materials are fiber cement and HPL (high-pressure laminates). Both are artificial materials. Typical for this type of cladding material is a wide range of colours and surface textures. The thickness of the façade panels usually range from 8 mm to 12 mm. The fischer Zykon panel

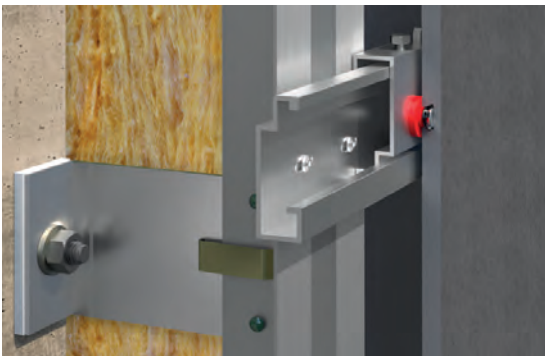

anchors can be used from a panel thickness of 8 mm. fischer partners with many different suppliers for such materials.

#### Panel anchor for thin materials such as fibre cement and HPL:

- FZP II T PA
- Tergo+

### View with glass.

fischer offers the world's first undercut glass point fixing for glazings made of single-pane safety glass (ESG or ESG-H from 10 mm glass thickness) and laminated safety glass (VSG from 8 + 10 mm glass thickness). The glass panels can be enamelled or coated and may also be used as carriers for laminated solar elements.

The German Institute for Building Technology (DIBt) in Berlin has issued the fischer Zykon point fixing (FZP-G) with a general technical approval. This revolutionary development is therefore state of the art and can now be applied without the need for project-specific approval for demanding glass façades. Through the application of undercut technology our company has

succeeded in offering globally the first point fixing for glass, which does not fully penetrate the panel with a hole. The smooth exterior of the glass façade offers architects greater creative freedom and, at the same time, reduces the susceptibility to soiling and the required cleaning effort.

To install the point fixing, proprietary drilling and setting tools are required. Specially equipped and trained companies offer the finishing of the glazings and the assembly of the point fixings. On request we will be glad to arrange contact between you and these specialist installers.



#### The fischer glass anchor:

- FZP G-Z ESG
- FZP G-Z VSG

In case of any further questions regarding the different materials and their fixing solutions, we will be happy to advise you.

# Zykon-Panel anchor FZP II A4

The universal undercut anchor made of A4 stainless steel for natural stone.

2



Flush installation in natural stone



Façade cross-section with flush installation

## Applications

- Exterior façades
- Interior façades
- Façade reveals
- Natural stone heating systems

## Certificates



ETA-11/0145



INOX STAINLESS STEEL

## Advantages

- The adapted shape of the undercut anchor ensures a positive-locking attachment free from expansion pressure in a conical undercut drill hole.
- The fixing of the undercut anchor is not visible on the exposed side, creating a visually attractive and consistent façade surface.
- Setting the anchor using undercut technology allows the user to always select the optimal structural position in the façade panel. This greatly reduces panel deflection.
- The anchor allows for higher pull-out loads, compared to commonly available systems.
- The flush-mounting technology of the undercut anchor allows an easy, economical handling of reveals.

## Functioning

- Use wet diamond drilling - first cylindrical, then conical - to drill an undercut hole.
- When the undercut anchor is installed, an optimal, positive-locking connection is created between the expanding part and the drill hole.
- The anchor is installed at the absolute anchoring depth and therefore flush with the material.

## Building materials

- Natural stone ( $\geq 20\text{mm}$ )
- Artificial concrete panels

## Installation FZP II A4

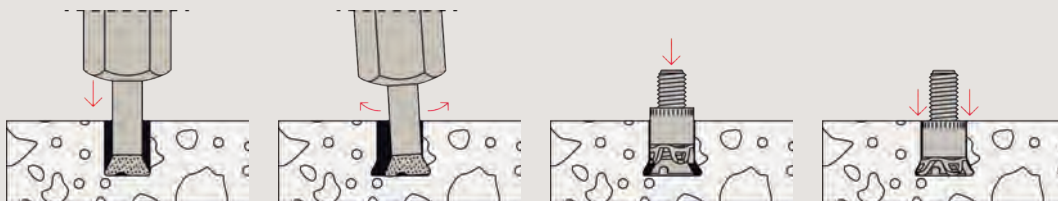





Al Hamra Tower · Kuwait

Technical data



Zykon-Panel anchor FZP II A4

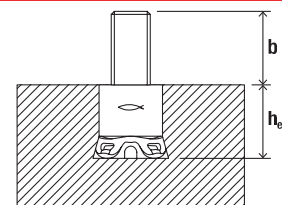

Item	Item No.	Approval ETA	Anchorage depth $h_{ef}$ [mm]	Projection length $b$ [mm]	Thread M	cylindrical diameter [mm]	Undercut- diameter [mm]	Min. panel thickness [mm]	Sleeve material	Sales unit [pcs]
FZP II 11 x 12 M6/13 A4	512131	●	12	13	M 6	11	13.5	20	stainless steel	250
FZP II 11 x 12 M6/18 A4	512133	●	12	18	M 6	11	13.5	20	stainless steel	250
FZP II 11 x 15 M6/10 A4	512134	●	15	10	M 6	11	13.5	30	stainless steel	250
FZP II 11 x 15 M6/18 A4	512135	●	15	18	M 6	11	13.5	30	stainless steel	250
FZP II 13 x 15 M8/10 A4	512136	●	15	10	M 8	13	15.5	30	stainless steel	250
FZP II 13 x 15 M8/15 A4	512137	●	15	15	M 8	13	15.5	30	stainless steel	250
FZP II 13 x 15 M8/23 A4	512138	●	15	23	M 8	13	15.5	30	stainless steel	250
FZP II 13 x 15 M8/28 A4	512139	●	15	28	M 8	13	15.5	30	stainless steel	250
FZP II 13 x 17 M8/17 A4	512140	●	17	17	M 8	13	15.5	30	stainless steel	250
FZP II 13 x 21 M8/9 A4	512141	●	21	9	M 8	13	15.5	35	stainless steel	250
FZP II 13 x 21 M8/17 A4	512142	●	21	17	M 8	13	15.5	35	stainless steel	250
FZP II 13 x 21 M8/22 A4	512143	●	21	22	M 8	13	15.5	35	stainless steel	250

# Zykon-Panel anchor FZP II Carbon

The universal carbon fibre-reinforced undercut anchor for natural stone.

2



Flush installation in natural stone



Façade cross-section with flush installation

## Applications

- Exterior façades
- Interior façades
- Façade reveals
- Natural stone heating systems

## Certificates



ETA-11/0145



INOX STAINLESS STEEL

## Advantages

- The adapted shape of the undercut anchor ensures a positive-locking attachment free from expansion pressure in a conical undercut drill hole.
- The fixing of the undercut anchor is not visible on the exposed side, creating a visually attractive and consistent façade surface.
- Setting the anchor using undercut technology allows the user to always select the optimal structural position in the façade panel. This greatly reduces panel deflection.
- The anchor allows for higher pull-out loads, compared to commonly available systems.
- The flush-mounting technology of the undercut anchor allows an easy, economical handling of reveals.

## Functioning

- Use wet diamond drilling - first cylindrical, then conical - to drill an undercut hole.
- When the undercut anchor is installed, an optimal, positive-locking connection is created between the expanding part and the drill hole.
- The anchor is installed at the absolute anchoring depth and therefore flush with the material.

## Building materials

- Natural stone ( $\geq 20\text{mm}$ )
- Artificial concrete panels

## Installation FZP II Carbon







Court Complex · Hawaaly · Kuwait

### Technical data



Zykon-Panel anchor FZP II Carbon

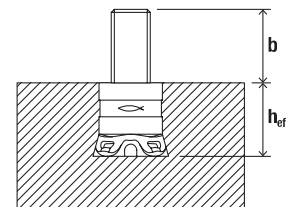

Item	Item No.	Approval ETA	Anchorage depth $h_{ef}$ [mm]	Projection length $b$ [mm]	Thread M	cylindrical diameter [mm]	Undercut-diameter [mm]	Min. panel thickness [mm]	Sleeve material	Sales unit [pcs]
FZP II 11 x 12 M6/13 CARBON	511966	●	12	13	M 6	11	13.5	20	Carbon	250
FZP II 11 x 12 M6/18 CARBON	511967	●	12	18	M 6	11	13.5	20	Carbon	250
FZP II 11 x 15 M6/10 CARBON	511968	●	15	10	M 6	11	13.5	30	Carbon	250
FZP II 11 x 15 M6/18 CARBON	511969	●	15	18	M 6	11	13.5	30	Carbon	250
FZP II 13 x 15 M8/10 CARBON	511970	●	15	10	M 8	13	15.5	30	Carbon	250
FZP II 13 x 15 M8/15 CARBON	511971	●	15	15	M 8	13	15.5	30	Carbon	250
FZP II 13 x 15 M8/23 CARBON	511972	●	15	23	M 8	13	15.5	30	Carbon	250
FZP II 13 x 15 M8/28 CARBON	511973	●	15	28	M 8	13	15.5	30	Carbon	250
FZP II 13 x 17 M8/17 CARBON	511980	●	17	17	M 8	13	15.5	30	Carbon	250
FZP II 13 x 21 M8/9 CARBON	511974	●	21	9	M 8	13	15.5	35	Carbon	250
FZP II 13 x 21 M8/17 CARBON	511975	●	21	17	M 8	13	15.5	35	Carbon	250
FZP II 13 x 21 M8/22 CARBON	511976	●	21	22	M 8	13	15.5	35	Carbon	250

# Zykon-Panel anchor FZP II SO AL

The adjusting undercut anchor made of A4 stainless steel for natural stone.



Stand-off installation in natural stone



Façade cross-section with stand-off installation

2

## Applications

- Exterior façades with high aesthetic requirements
- Interior façades with high aesthetic requirements

## Certificates



ETA-11/0145



INOX STAINLESS STEEL

## Advantages

- The adapted shape of the undercut anchor ensures a positive-locking attachment free from expansion pressure in a conical undercut drill hole.
- The fixing of the undercut anchor is not visible on the exposed side, creating a visually attractive and consistent façade surface.
- Setting the anchor using undercut technology allows the user to always select the optimal structural position in the façade panel. This greatly reduces panel deflection.
- The anchor allows for higher pull-out loads, compared to commonly available systems.
- Using a constant remaining wall thickness as a reference value when drilling holes allows users to compensate panel thickness tolerances.

## Functioning

- Wet diamond drilling - first cylindrical to a constant reference dimension for the remaining wall thickness (RWT), then conical to create an undercut drill hole.
- When the undercut anchor is installed, an optimal positive-locking connection is created between the expanding part and the drill hole.
- The anchor is installed in the conical undercut drill hole using stand-off installation.
- The ability to compensate for panel thickness tolerances helps create a flat façade surface.

## Building materials

- Natural stone ( $\geq 20\text{mm}$ )
- Artificial concrete panels

## Installation FZP II SO AL

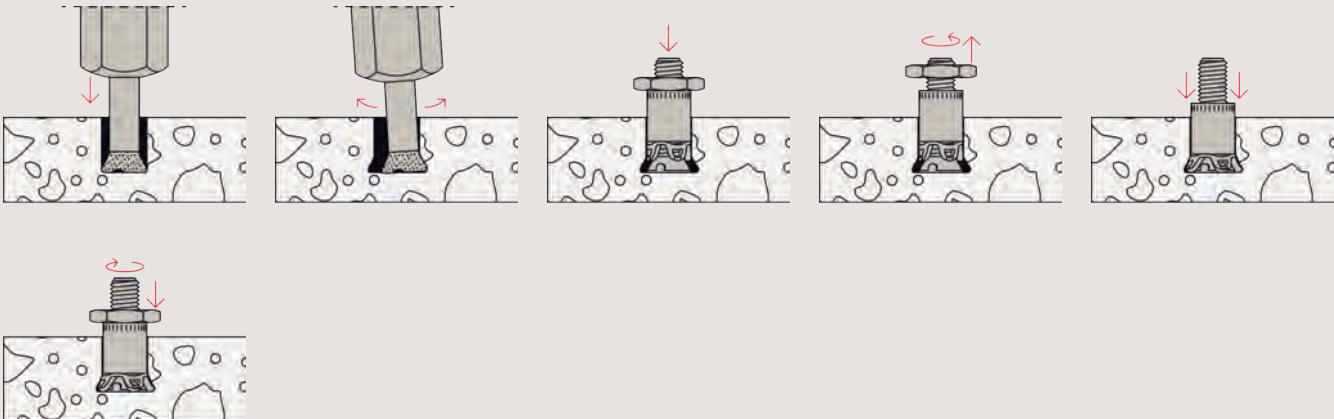





99 Hudson · New York · USA

**Technical data**



Zykon-Panel anchor  
FZP II SO AL

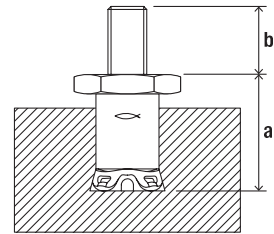

Item	Item No.	Approval ETA	Installed anchor length a [mm]	Anchorage depth $h_{ef}$ [mm]	Projection length b [mm]	Thread M	cylindrical diameter [mm]	Undercut-diameter [mm]	Min. panel thickness [mm]	Sleeve material	Sales unit [pcs]
FZP II 11 x 21 M6/SO/9 AL	512144	●	21	12 - 16	9	M 6	11	13.5	20	stainless steel	250
FZP II 11 x 21 M6/SO/12 AL	512145	●	21	12 - 16	12	M 6	11	13.5	20	stainless steel	250
FZP II 13 x 26 M8/SO/17 AL	512146	●	26	15 - 21	12	M 8	13	15.5	30	stainless steel	250
FZP II 13 x 30 M8/SO/13 AL	513226	●	30	15 - 25	12	M 8	13	15.5	30	stainless steel	250
FZP II 13 x 26 M8/SO/12 AL	538088	●	26	15 - 21	12	M 8	13	15.5	30	stainless steel	250

# Zykon-Panel anchor FZP II SO Carbon

The adjusting carbon fibre-reinforced undercut anchor for natural stone.

2



Stand-off installation in natural stone

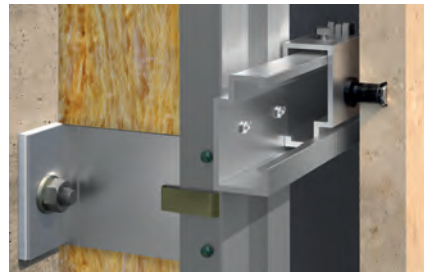

Façade cross-section with stand-off installation

## Applications

- Exterior façades with high aesthetic requirements
- Interior façades with high aesthetic requirements

## Certificates



ETA-11/0145



INOX STAINLESS STEEL

## Advantages

- The adapted shape of the undercut anchor ensures a positive-locking attachment free from expansion pressure in a conical undercut drill hole.
- The fixing of the undercut anchor is not visible on the exposed side, creating a visually attractive and consistent façade surface.
- Setting the anchor using undercut technology allows the user to always select the optimal structural position in the façade panel. This greatly reduces panel deflection.
- The anchor allows for higher pull-out loads, compared to commonly available systems.
- Using a constant remaining wall thickness as a reference value when drilling holes allows users to compensate panel thickness tolerances.

## Functioning

- Wet diamond drilling - first cylindrical to a constant reference dimension for the remaining wall thickness (RWT), then conical to create an undercut drill hole.
- When the undercut anchor is installed, an optimal positive-locking connection is created between the expanding part and the drill hole.
- The anchor is installed in the conical undercut drill hole using stand-off installation.
- The ability to compensate for panel thickness tolerances helps create a flat façade surface.

## Building materials

- Natural stone ( $\geq 20\text{mm}$ )
- Artificial concrete panels

## Installation FZP II SO Carbon

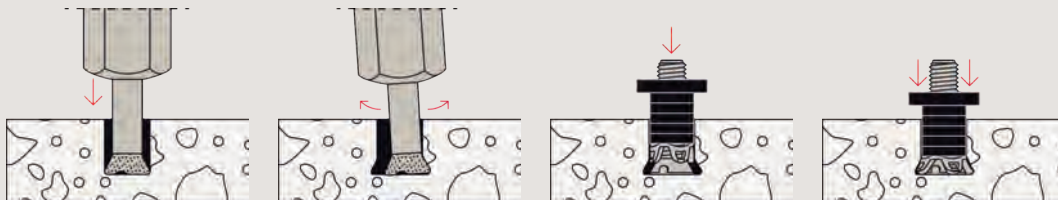



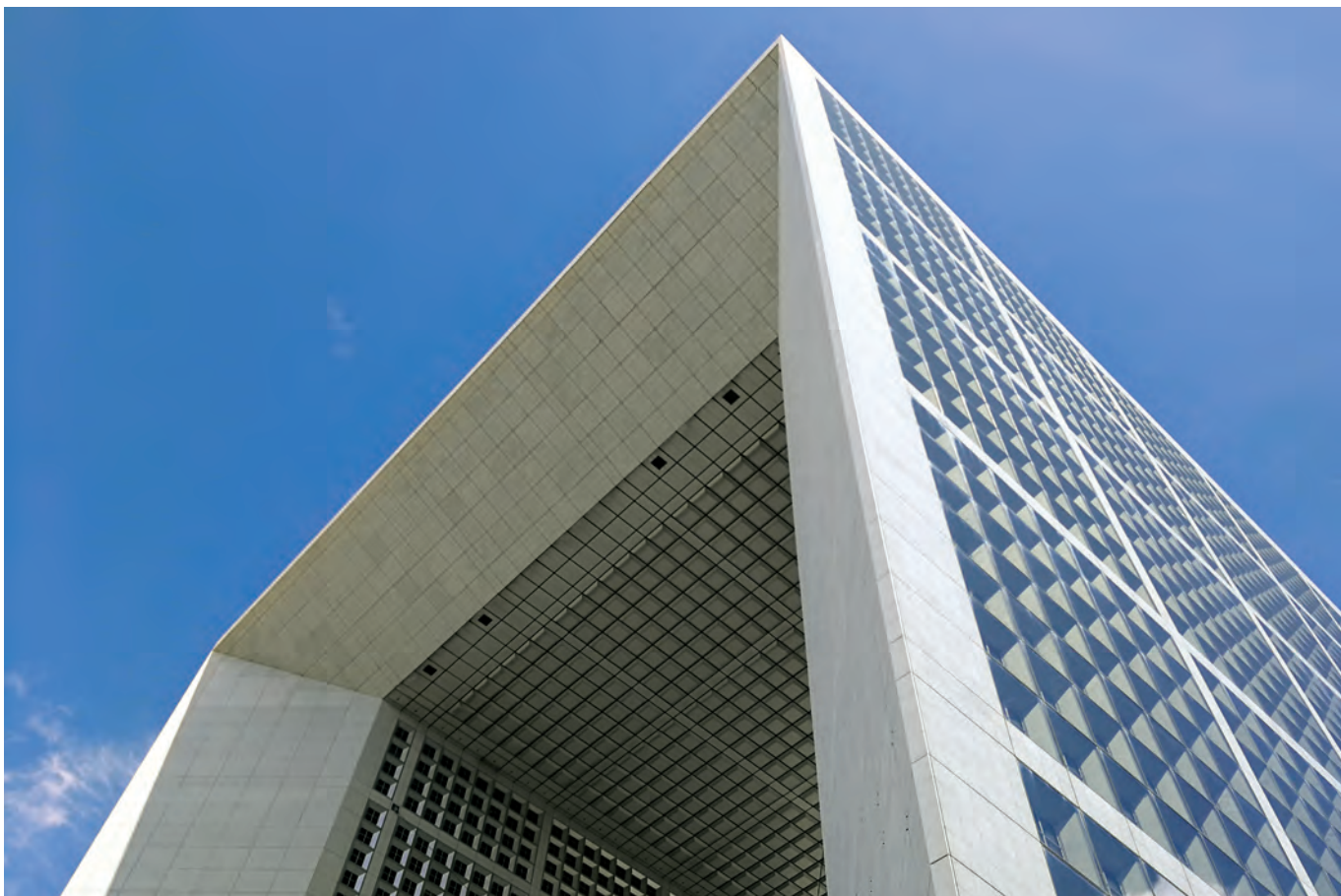

La Grande Arche · Paris · France

**Technical data**



Zykon-Panel anchor  
FZP II SO Carbon

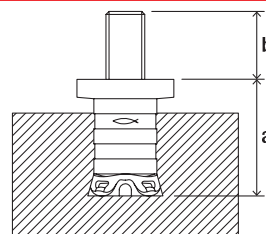

Item	Item No.	Approval ETA	Installed anchor length a [mm]	Anchorage depth $h_{ef}$ [mm]	Projection length b [mm]	Thread M	cylindrical diameter [mm]	Undercut diameter [mm]	Min. panel thickness [mm]	Sleeve material	Sales unit [pcs]
FZP II 11 x 21 M6/SO/9 CARBON	511977	●	21	12 - 16	9	M 6	11	13.5	20	Carbon	250
FZP II 11 x 21 M6/SO/12 CARBON	511978	●	21	12 - 16	12	M 6	11	13.5	20	Carbon	250
FZP II 13 x 26 M8/SO/12 CARBON	538087	●	26	15 - 21	12	M 8	13	15.5	30	Carbon	250
FZP II 13 x 26 M8/SO/17 CARBON	511979	●	26	15 - 21	17	M 8	13	15.5	30	Carbon	250

# Zykon-Panel anchor FZP II VS

The suspension anchor with the fischer Vertical Solution for natural stone façade panels.

2



Suspension anchor in natural stone

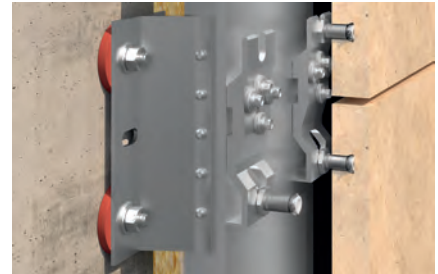

Façade cross-section with suspension anchor

## Applications

- Exterior façades with high aesthetic requirements and a reduced wall construction
- Interior façades with high aesthetic requirements and a reduced wall construction

## Certificates



ETA-11/0145



INOX STAINLESS STEEL

## Advantages

- The adapted shape of the undercut anchor ensures a positive-locking attachment free from expansion pressure in a conical undercut drill hole.
- The fixing of the undercut anchor is not visible on the exposed side, creating a visually attractive and consistent façade surface.
- Setting the anchor using undercut technology allows the user to always select the optimal structural position in the façade panel. This greatly reduces panel deflection.
- The anchor allows for higher pull-out loads, compared to commonly available systems.
- Using a constant remaining wall thickness as a reference value when drilling holes allows users to compensate panel thickness tolerances.

## Functioning

- Wet diamond drilling - first cylindrical to a constant reference dimension for the remaining wall thickness (RWT), then conical to create an undercut drill hole.
- When the undercut anchor is installed, an optimal positive-locking connection is created between the expanding part and the drill hole.
- The anchor is installed in the conical undercut drill hole using stand-off installation.
- The ability to compensate panel thickness tolerances helps create a flat façade surface.
- Suspension brackets designed based on a lock and key principle are also used during installation.

## Building materials

- Natural stone ( $\geq 20\text{mm}$ )

## Installation FZP II VS

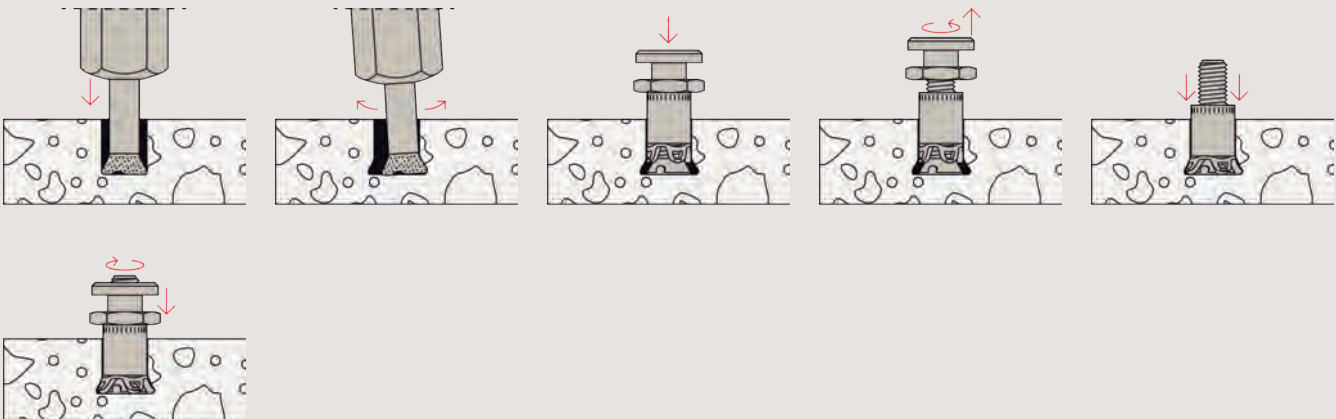





Concorde Hotel · Berlin · Germany

### Technical data



Zykon-Panel anchor FZP II VS

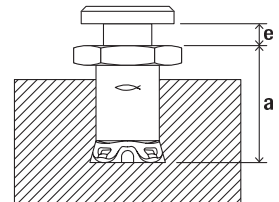

Item	Item No.	Approval ETA	Installed anchor length a [mm]	Anchorage depth $h_{ef}$ [mm]	Useable length e [mm]	Thread M	cylindrical diameter [mm]	Undercut- diameter [mm]	Min. panel thickness [mm]	Sleeve material	Sales unit [pcs]
FZP II 11 x 21 M6/VS/4 AL	512147	●	21	12 - 16	4.5	M 6	11	13.5	20	stainless steel	250
FZP II 13 x 26 M8/VS/4 AL	512148	●	26	15 - 21	4.5	M 8	13	15.5	30	stainless steel	250
FZP II 13 x 30 M8/VS/4 AL	512149	●	30	15 - 25	4.5	M 8	13	15.5	30	stainless steel	250

# Zykon-Panel anchor FZP II SH

The undercut anchor for soft stone façade panels.

2



Undercut anchor in soft natural stone

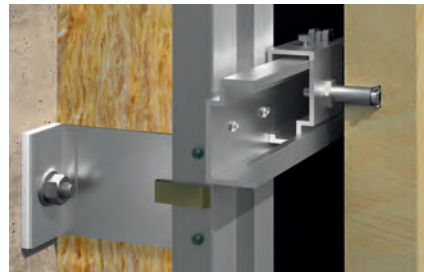

Façade cross-section with soft stone anchor

## Applications

- Exterior façades with heavy façade panels made of selected, soft natural stone (stone group IV - sedimentary rock)
- Interior façades with heavy façade panels made of selected, soft natural stone (stone group IV - sedimentary rock)

## Certificates



INOX STAINLESS STEEL

## Advantages

- The adapted shape of the undercut anchor ensures a positive-locking attachment free from expansion pressure in a conical undercut drill hole.
- The attachment point is not externally visible, creating a visually attractive and consistent façade surface.
- Setting the anchor using undercut technology allows the user to always select the optimal structural position in the façade panel. This greatly reduces panel deflection.
- The anchor allows for higher breaking loads, compared to commonly available systems.
- Using a constant remaining wall thickness as a reference value when drilling holes allows users to compensate for panel thickness tolerances.

## Functioning

- Wet diamond drilling - first cylindrical, depending on the application either to the absolute anchoring depth or to a constant reference dimension for the remaining wall thickness (RWT), then conical to create an undercut drill hole.
- When the undercut anchor is installed, an optimal positive-locking connection is created between the expanding part and the drill hole.
- The anchor can either be installed flush to the absolute anchoring depth or can be installed in the conical undercut drill hole using stand-off installation.
- The ability to compensate panel thickness tolerances helps create a flat façade surface.

## Building materials

- Natural stone (stone group IV) (≥ 50mm)

## Installation FZP II SH

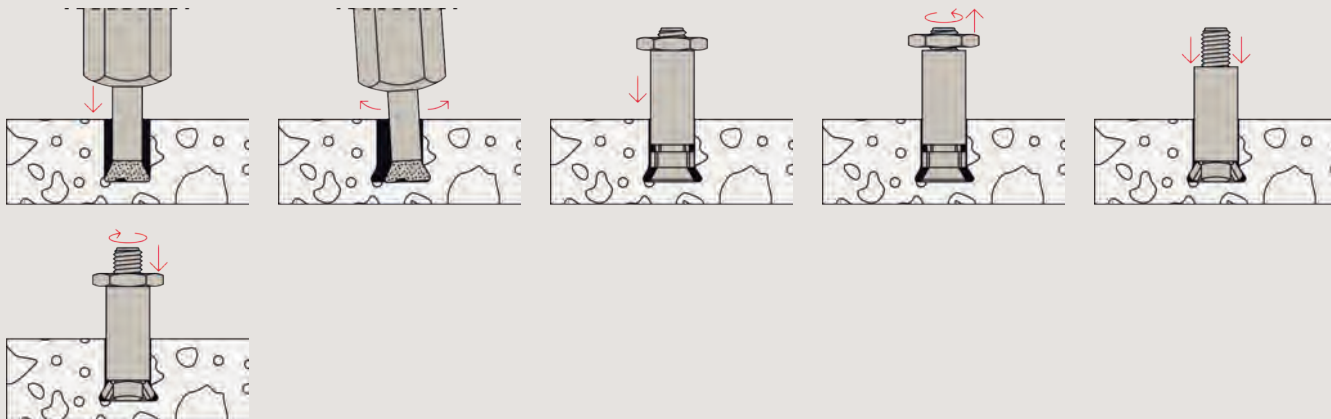





Bucherer · Zurich · Switzerland

**Technical data**



Zykon-Panel anchor FZP II SH

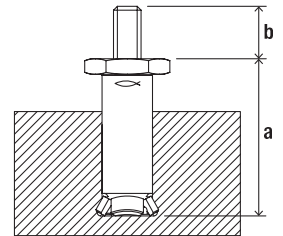

Item	Item No.	Installed anchor length a [mm]	Anchorage depth $h_{ef}$ [mm]	Projection length b [mm]	Thread M	cylindrical diameter [mm]	Undercut-diameter [mm]	Min. panel thickness [mm]	Sleeve material	Sales unit [pcs]
FZP 13 x 30 M8//23 SH A4	521103	30	30	23	M 8	13	17.3	50	stainless steel	50
FZP 13 x 41 M8/S0/19 SH AL	521104	41	30 - 36	19	M 8	13	17.3	50	stainless steel	50

# Zykon-Panel anchor FZP II M8i

The undercut anchor with an internal thread for M8 threaded screws in natural stone façade panels.

2



Internal threaded anchor in natural stone



Façade cross-section with internal threaded anchor

## Applications

- Exterior façades
- Interior façades
- Façade reveals

## Certificates



ETA-11/0145



INOX STAINLESS STEEL

## Advantages

- The adapted shape of the undercut anchor ensures a positive-locking attachment free from expansion pressure in a conical undercut drill hole.
- The fixing of the undercut anchor is not visible on the exposed side, creating a visually attractive and consistent façade surface.
- The anchor allows for higher pull-out loads, compared to commonly available systems.
- The flush-mounted anchor allows for easy, economical construction of reveals.
- Depending on the application, the user can choose between flush installation with an absolute anchoring depth, for instance for reveal panels, and stand-off installation technology with a constant remaining wall thickness that serves as a reference dimension to compensate panel thickness tolerances.
- There is no protruding external thread, allowing a space-saving transportation of pre-fabricated façade panels.

## Functioning

- Wet diamond drilling - first cylindrical, depending on the application either to the absolute anchoring depth or to a constant reference dimension for the remaining wall thickness (RWT), then conical to create an undercut drill hole.
- When the undercut anchor is installed, an optimal positive-locking connection is created between the expanding part and the drill hole.
- The anchor can either be installed flush to the absolute anchoring depth or can be installed in the conical undercut drill hole using stand-off installation.
- The ability to compensate panel thickness tolerances helps create a flat façade surface.

## Building materials

- Natural stone ( $\geq 20\text{mm}$ )

## Installation FZP II M8i







fischer administration building · Waldachtal · Germany

**Technical data**



Zykon-Panel anchor  
FZP II M8i

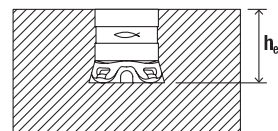

Item	Item No.	Approval ETA	Anchorage depth $h_{ef}$ [mm]	cylindrical diameter [mm]	Undercutdiameter [mm]	Min. panel thick- ness [mm]	Sleeve material	Sales unit [pcs]
FZP II 15 x 12 M8i	539478	●	12	15	17.5	20	Carbon	250
FZP II 15 x 15 M8i	539479	●	15	15	17.5	25	Carbon	250
FZP II 15 x 21 M8i	540298	●	21	15	17.5	35	Carbon	250

These anchors are supplied with dust protection caps. These can be used to protect the internal thread from contamination if the undercut anchors are prefabricated at the factory and delivered to the construction site without an installed set thread.

# Zykon-Panel anchor FZP II M6i

The undercut anchor with an internal thread for M6 threaded screws in natural stone façade panels.

2



Internal threaded anchor in natural stone



Façade cross-section with internal threaded anchor

## Applications

- Indoor applications (such as wash basins, natural stone heating systems, ...)

## Certificates



INOX STAINLESS STEEL

## Advantages

- The adapted shape of the undercut anchor ensures a positive-locking attachment free from expansion pressure in a conical undercut drill hole.
- The fixing of the undercut anchor is not visible on the exposed side, creating a visually attractive and consistent façade surface.
- The high-quality material of the anchor allows for higher pull-out loads than commonly used systems.
- The integrated internal thread allows panels to be pre-fabricated and transported securely.

## Functioning

- Wet diamond drilling - first cylindrical, depending on the application either to the absolute anchoring depth or to a constant reference dimension for the remaining wall thickness (RWT), then conical to create an undercut drill hole.
- When the undercut anchor is installed, an optimal positive-locking connection is created between the expanding part and the drill hole.
- The anchor can either be installed flush to the absolute anchoring depth or can be installed in the conical undercut drill hole using stand-off installation.
- The ability to compensate panel thickness tolerances helps create a flat façade surface.

## Building materials

- Natural stone ( $\geq 20\text{mm}$ )

## Installation FZP II M6i







Huyyu-Chen-Fong · Taiwan

**Technical data**



Zykon-Panel anchor  
FZP II M6i

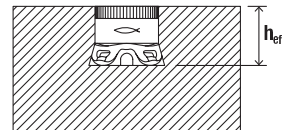

Item	Item No.	Anchorage depth $h_{ef}$ [mm]	cylindrical diameter [mm]	Undercutdiameter [mm]	Min. panel thick- ness [mm]	Sleeve material	Sales unit [pcs]
FZP II 13 x 12 M6i	512958	12	13	15.5	20	Polyamide PA6	250

# Zykon-Panel anchor FZP II T Tergo+

The specialist for thin fibre cement façade panels by Equitone.

2



Tergo+ in Equitone fibre cement boards

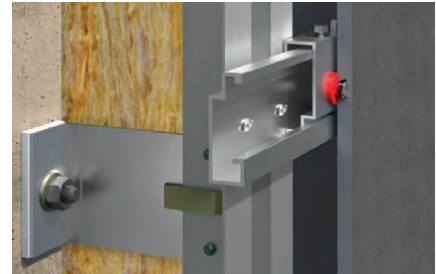

Façade cross-section with Tergo+ anchor

## Applications

- Exterior façades
- Interior façades
- Façade reveals

## Certificates



## Advantages

- The anchors' short geometry allows it to be used in thin panels with a thickness greater than 8 mm.
- The fixing of the undercut anchor is not visible on the exposed side, creating a visually attractive and consistent façade surface.
- The adapted shape of the undercut anchor ensures a positive-locking attachment free from expansion pressure in a conical undercut drill hole.
- Setting the anchor using undercut technology allows the user to always select the optimal structural position in the façade panel. This greatly reduces panel deflection.
- The positive-locking anchor is free from expansion pressure and is attached at the fifth point in a structurally optimised location. This provides much better holding force than commonly available systems and allows for the use of large-format panels.

## Functioning

- Use dry drilling with a diamond drill bit - first cylindrical, then conical - to drill an undercut hole.
- When the undercut anchor is installed, an optimal, positive-locking connection is created between the expanding part and the drill hole.
- The anchor is installed flush to the absolute anchoring depth. After the anchor is set, the spacer washer will be in full contact with the surface of the material.

## Building materials

- Equitone fibre cement ( $\geq 8\text{mm}$ )

## Installation FZP II T Tergo+







Cahir Castle · Tipperary · Ireland

**Technical data**



Tergo+ 11 x 6

Tergo+ 11 x 8

Tergo+ 11 x 10

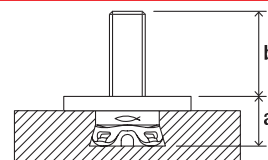

Item	Item No.	Approval DIBt	Installed anchor length a [mm]	Anchorage depth $h_{ef}$ [mm]	Projection length b [mm]	Thread $\varnothing$ x length [mm]	cylindrical diameter [mm]	Undercut diameter [mm]	Min. panel thickness [mm]	Sleeve material	Sales unit [pcs]
Tergo+ 11 x 6 M6/T/10 PA	532641	●	8.5	6	10		11	13.5	8	Polyamide PA6	250
Tergo+ 11 x 6 M6/T/13 PA	532642	●	8.5	6	13		11	13.5	8	Polyamide PA6	250
Tergo+ 11 x 8 M6/T/10 PA	537974	●	10.5	8	10		11	13.5	12	Polyamide PA6	250
Tergo+ 11 x 8 M6/T/13 PA	537975	●	10.5	8	13		11	13.5	12	Polyamide PA6	250
Tergo+ 11 x 10 M6/T/9 PA	532643	●	12.5	10	9		11	13.5	14	Polyamide PA6	250

These anchors are supplied with M6 locknuts, which have to be used for the installation of the clasps.

# Zykon-Panel anchor FZP II T PA

The specialist for thin façade panels, such as HPL and fibre cement.

2

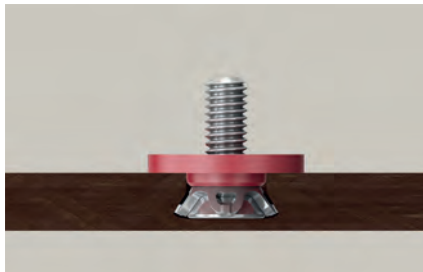

Undercut anchor in HPL board



Façade cross-section with FZP II T PA

## Applications

- Exterior façades
- Interior façades
- Façade reveals

## Certificates



ETA-11/0465



## Advantages

- The anchor's short geometry allows it to be used in thin panels with a thickness greater than 8 mm.
- The fixing of the undercut anchor is not visible on the exposed side, creating a visually attractive and consistent façade surface.
- The adapted shape of the undercut anchor ensures a positive-locking attachment free from expansion pressure in a conical undercut drill hole.
- Setting the anchor using undercut technology allows the user to always select the optimal structural position in the façade panel. This greatly reduces panel deflection.
- The positive-locking anchor is free from expansion pressure provides much better holding force than commonly available systems and allows for the use of large-format panels.

## Functioning

- Use dry drilling with a diamond drill bit - first cylindrical, then conical - to drill an undercut hole.
- When the undercut anchor is installed, an optimal, positive-locking connection is created between the expanding part and the drill hole.
- The anchor is installed flush to the absolute anchoring depth. After the anchor is set, the spacer washer will be in full contact with the surface of the material.

## Building materials

- Fibre cement
- HPL panels
- Thin panel materials ( $\geq 8$  mm)

## Installation FZP II T PA







Stabilo Cube · Heroldsberg · Germany

Technical data



FZP II-T PA 11 x 6

FZP II-T PA 11 x 8

FZP II-T PA 11 x 10

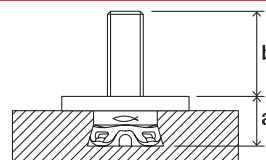

Item	Item No.	Approval ETA	Installed anchor length a [mm]	Anchorage depth $h_{ef}$ [mm]	Projection length b [mm]	Thread $\emptyset$ x length [mm]	cylindrical diameter [mm]	Undercut-diameter [mm]	Min. panel thickness [mm]	Sleeve material	Sales unit [pcs]
FZP II 11 x 6 M6/T/10 PA	520365	●	8.5	6	10		11	13.5	8	Polyamide PA6	250
FZP II 11 x 8 M6/T/12 PA	520367	●	10.5	8	12		11	13.5	10	Polyamide PA6	250
FZP II 11 x 10 M6/T/9 PA	520369	●	12.5	10	9		11	13.5	12	Polyamide PA6	250

# Zykon-Panel anchor FZP II T D40

The specialist for thin ceramic façade panels.

2



Undercut anchor in ceramic tiles



Façade cross-section with ceramic anchor

## Applications

- Exterior façades
- Interior façades
- Façade reveals

## Certificates



ETA-11/0465

## Advantages

- The anchors' short geometry allows it to be used in thin panels with a thickness greater than 10 mm.
- The fixing of the undercut anchor is not visible on the exposed side, creating a visually attractive and consistent façade surface.
- The adapted shape of the undercut anchor ensures a positive-locking attachment free from expansion pressure in a conical undercut drill hole.
- Setting the anchor using undercut technology allows the user to always select the optimal structural position in the façade panel. This greatly reduces panel deflection.
- The positive-locking anchor is free from expansion pressure provides much better holding force than commonly available systems and allows for the use of large-format panels.

## Functioning

- Use wet diamond drilling - first cylindrical, then conical - to drill an undercut hole.
- When the undercut anchor is installed, an optimal positive-locking connection is created between the expanding part and the drill hole.
- The anchor is installed flush to the absolute anchoring depth. After the anchor is set, the spacer washer will be in full contact with the surface of the material.

## Building materials

- Ceramics
- Fine stoneware ( $\geq 10\text{mm}$ )

## Installation FZP II T D40

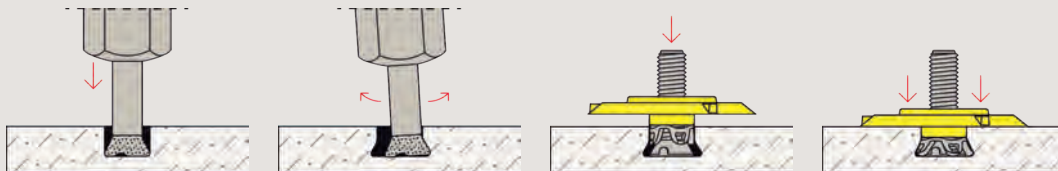





Nieuwe Haagse Passage · The Hague · Netherlands

**Technical data**



FZP II 11 x 6 D40



FZP II 11 x 8 D40



FZP II 11 x 9 D40

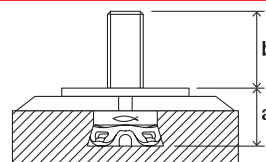

Item	Item No.	Approval ETA	Installed anchor length a [mm]	Anchorage depth $h_{ef}$ [mm]	Projection length b [mm]	Thread $\emptyset$ x length [mm]	cylindrical diameter [mm]	Undercut-diameter [mm]	Min. panel thickness [mm]	Sleeve material	Sales unit [pcs]
FZP II 11 x 6 M6/T/9 D40 PA	532644	●	9.5	6	9		11	13.5	10	Polyamide PA6	250
FZP II 11 x 8 M6/T/10 D40 PA	532645	●	11.5	8	10		11	13.5	12	Polyamide PA6	250
FZP II 11 x 9 M6/T/9 D40 PA	532646	●	12.5	9	9		11	13.5	13	Polyamide PA6	250

# Zykon-Glas point fixing FZP G Z ESG

The glass point holder for aesthetic fixing of single layered glass façade panels.

2

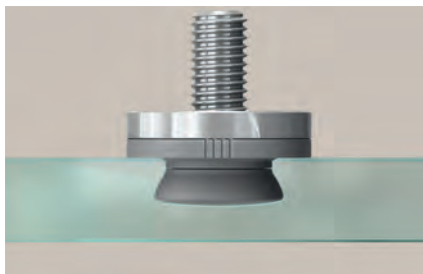

Glass point holder in single layered glass panels



Façade cross-section with single layered glass panel

## Applications

- Exterior façades
- Interior façades
- Glass façades

## Certificates



## Advantages

- The geometry of the anchor requires only a small drill hole diameter, allowing for a discreet and visually attractive fixing solution.
- There is no need to drill through the glass façade panel to install the anchor. This adds more safety. The fastening point remains inside the façade panels and does not penetrate through to the outside. This reduces the danger of contamination and ensures a good seal.
- Create an undercut drill hole and chamfer the edge of the drill hole in one work step.

## Functioning

- Before glass hardening: use wet diamond drilling - first cylindrical, then conical - to drill an undercut hole.
- After drilling the glass, the glass must be hardened before the undercut anchors can be set.
- When the undercut anchor is set, an optimal, positive-locking connection is created between the expanding part and the drill hole.

## Building materials

- Single layer safety glass ( $\geq 10\text{mm}$ )
- Glass ceramic ( $\geq 10\text{mm}$ )

## Installation in single layer safety glass

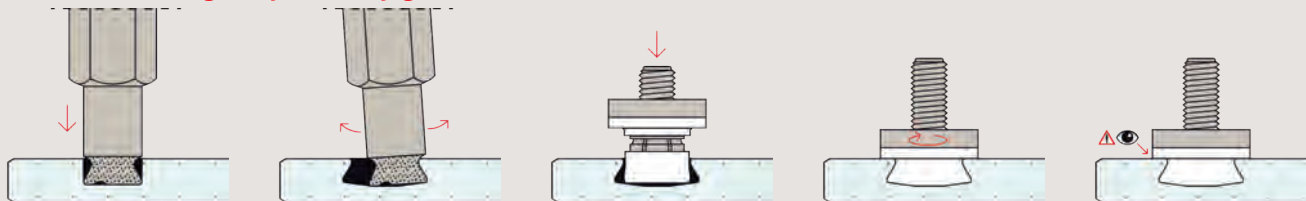





Bahai Temple · Santiago de Chile · Chile

**Technical data**

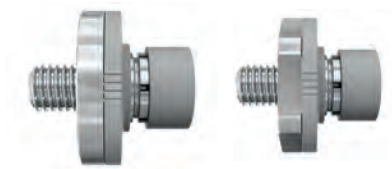

FZP G Z (ESG)

FZP G Z 6kt (ESG)

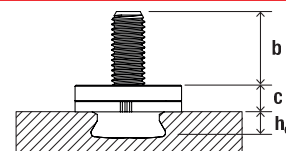

Item	Item No.	Approval DIBt	Drill hole diameter [mm]	Bolt projection length b [mm]	Structural height c [mm]	Anchorage depth h <sub>ef</sub> [mm]	Glass structure	Sales unit [pcs]
FZP 15 x 6 M8/11 G-Z	047254	●	15	11.5	6.5	6	≥ 10	100
FZP 15 x 6 M8/25 G-Z	047259	●	15	25	6.5	6	≥ 10	100
FZP 15 x 7 M8/10 G-Z	047273	●	15	10.5	6.5	7	≥ 12	100
FZP 15 x 7 M8/24 G-Z	047274	●	15	24	6.5	7	≥ 12	100
FZP 15 x 6 M8/11 G-Z 6KT	051435	●	15	11.5	6.5	6	≥ 10	100
FZP 15 x 6 M8/25 G-Z 6KT	051436	●	15	25	6.5	6	≥ 10	100
FZP 15 x 7 M8/10 G-Z 6KT	051440	●	15	10.5	6.5	7	≥ 12	100
FZP 15 x 7 M8/24 G-Z 6KT	051441	●	15	24	6.5	7	≥ 12	100

# Zykon-Glas point fixing FZP G Z VSG

The glass point holder for aesthetic fixing of laminated composite safety glass.

2

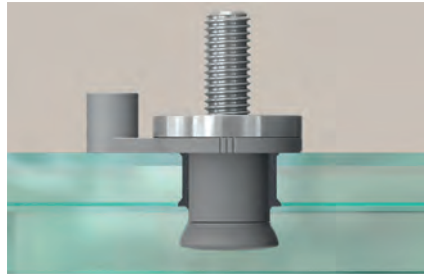

Glass point holder in laminated composite safety glass



Façade cross-section with laminated composite safety glass

## Applications

- Exterior façades
- Interior façades

## Certificates



## Advantages

- The geometry of the anchor requires only a small drill hole diameter, allowing for a discreet and visually attractive fixing solution.
- There is no need to drill through the glass façade panel to install the anchor. This adds more safety. The fastening point remains inside the façade panels and does not penetrate through to the outside. This reduces the danger of contamination and ensures a good seal.
- Create an undercut drill hole and chamfer the edge of the drill hole in one work step.

## Functioning

- Before glass hardening: use wet diamond drilling - first cylindrical, then conical - to drill an undercut hole.
- After drilling the glass, the glass must be hardened before the undercut anchors can be set.
- When the undercut anchor is set, an optimal, positive-locking connection is created between the expanding part and the drill hole.

## Building materials

- Laminated composite safety glass (>18mm)

## Installation in laminated composite safety glass

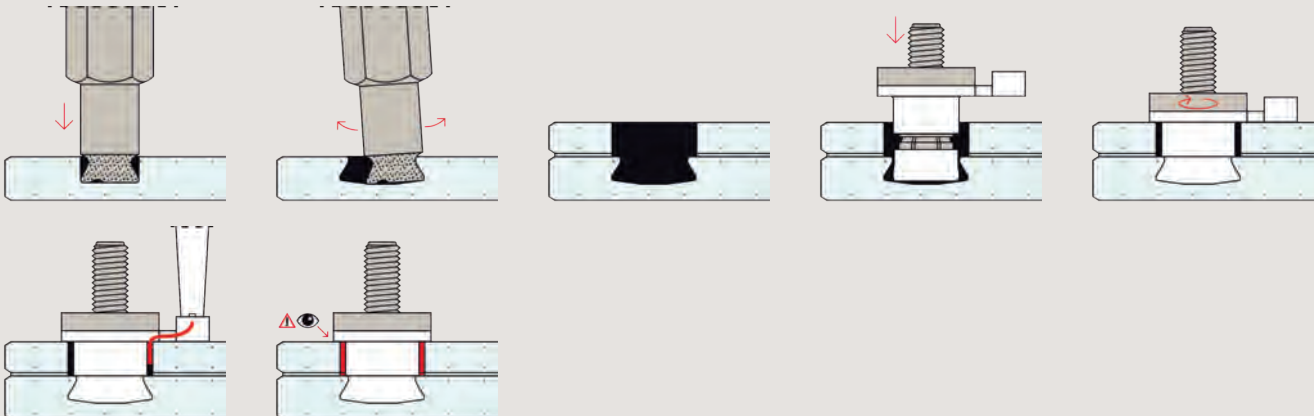





FRAC art centre · Marseille · France

**Technical data**

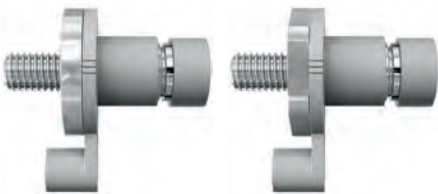

FZP G Z (VSG)

FZP G Z 6kt (VSG)

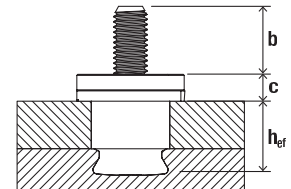

Item	Item No.	Approval DIBt	Drill hole diameter [mm]	Structural height c [mm]	Bolt projection length b [mm]	Anchorage depth h <sub>ef</sub> [mm]	Glass struc- ture	Thread A	Sales unit [pcs]
FZP 15 x 15,5 M8/16 G-Z	047300	●	15	6.5	16	15,5	10/8	M 8	100
FZP 15 x 17,5 M8/14 G-Z	050407	●	15	6.5	14	17,5	10/10	M 8	100
FZP 15 x 15,5 M8/16 G-Z 6KT	051442	●	15	6.5	16	15,5	10/8	M 8	100
FZP 15 x 17,5 M8/14 G-Z 6KT	051447	●	15	6.5	14	17,5	10/10	M 8	100



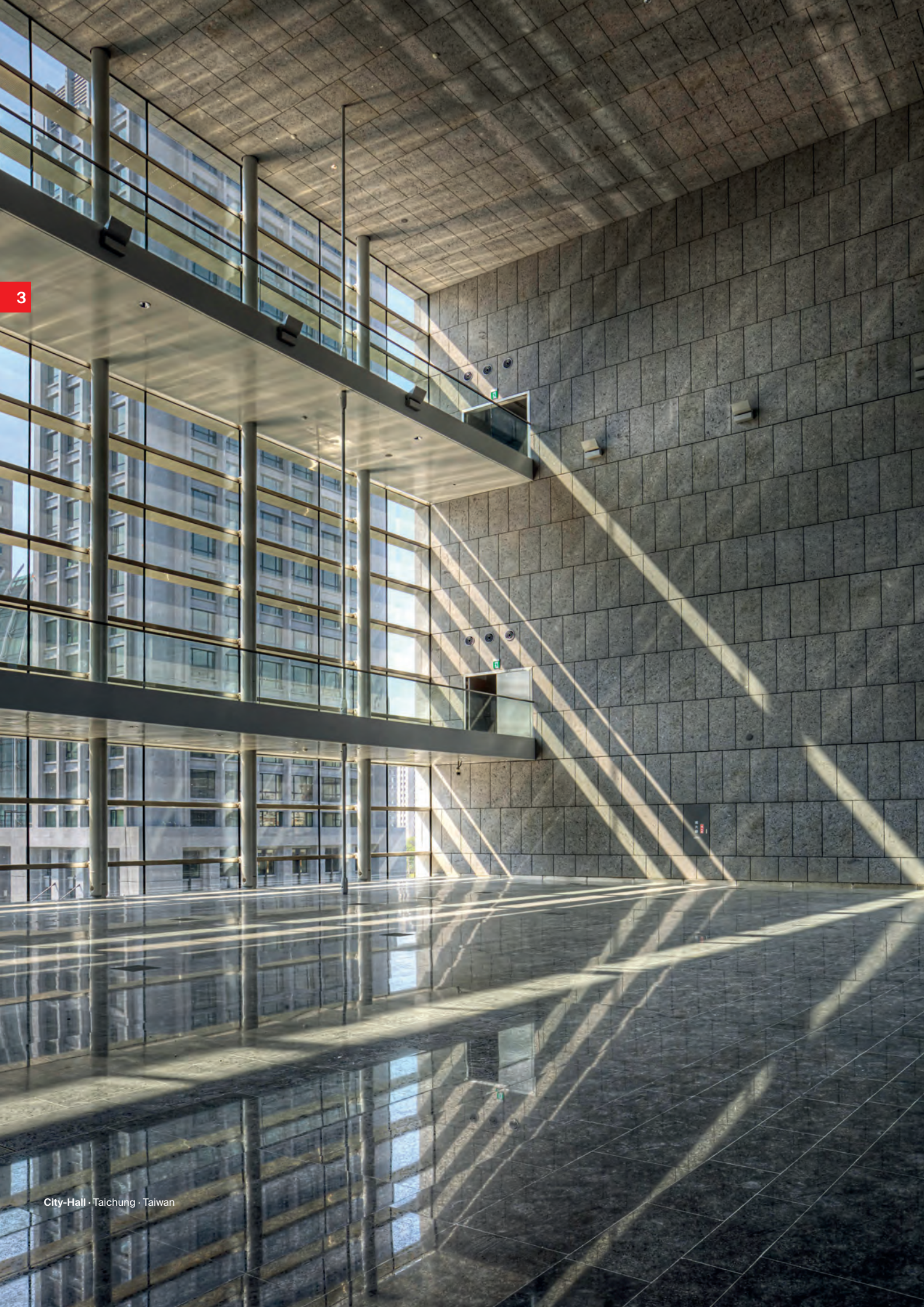



# 3

## Machine technology and drill bits

### DRILLING MACHINES

---

Mobile drilling equipment BSN 100 53



Drill rig SBN 502 54



Mobile drilling equipment LBT 80 55



Manual drill head MB 2 56



Mobile drilling equipment BSN 101T 57



Side table BST 58



### DRILL BITS

---

Undercut drill bits 61



Undercut drill bits CNC 62



Undercut drill bits glass 63



### TESTING AND MEASURING EQUIPMENT

---

Measuring equipment 65



### SETTING TOOLS

---

Setting tools 69





# A fully coordinated complete system.

The perfect solution for rainscreen façades.

Just as much know-how as for the development of the Zykon panel anchor and sub-frame systems has been invested in the machine technology. This forms an indispensable part of the façade system.

The machine technology includes not only fischer drilling machines and drill bits, which are specially developed for the creation of the undercut drill holes, but also

test and measuring equipment for quality control of the hole geometry and setting tools to ensure safe and fast installation of the fischer Zykon panel anchors.

In addition, it is possible to make the undercut holes using your own CNC machining equipment.





Bellavita Shopping Mall - Taipei - Taiwan

  
BELLAVITA

LANE BOWEN



# Drilling machines

to ensure correct undercut drill hole geometry for fischer Zykon panel anchors.

fischer offers proprietary machines of various sizes, from portable on-site up to large-scale production equipment. These machines enable the fast and economic production of drill holes with diamond drilling tools. Quality control of the drilled holes is then carried out by taking the hole dimensions with the testing and measuring equipment and comparing them with the target dimensions and tolerance specifications. Finally, the undercut anchors are installed in the undercut holes of the façade panels using the appropriate setting devices.

The fixing specialists at fischer façade systems offer a wide range of services in this context:

- Diverse range of machines
- Large-scale production machines
- Support with machine selection
- Purchase/rental of the machines

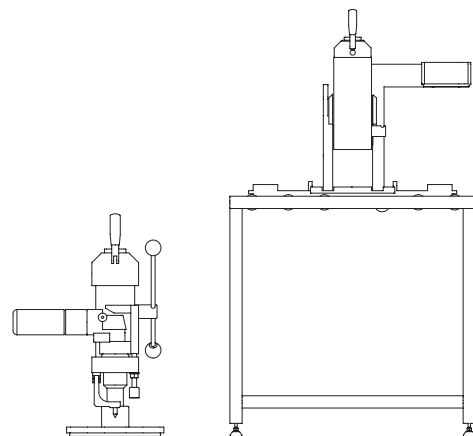

# Mobile drilling equipment BSN 100

Undercut drilling machines for wet diamond drilling of natural stone and ceramic façade panels.



## Advantages

- Easy handling
- Economic creation of undercut drill holes
- Construction site machine

## Functioning

- Diamond drilling
- Water cooling
- Undercutting
- Wet drilling
- Vacuum

## Building materials

- Natural stone ( $\geq 20\text{mm}$ )
- Artificial concrete panels
- Ceramics ( $\geq 10\text{mm}$ )
- Solid-surface materials

## Technical data

Item	Item No.	Useable material	Drill bit	Drilling Technology	Dimensions [mm]	Weight [kg]	Connections	Power input [W]	Water connection	Water consumption
BSN 100 VP	061502 <sup>2)</sup>	natural stone, ceramic	Diamond drill bit	Manual MB 1	340 x 450 x 480	20	230 V, 10/16 A	1200	1/2 inch cross section, at least 2 bar fresh water	1,5 L/min (idle running)
BSN 100 VD	046223 <sup>1)</sup>	natural stone, ceramic	Diamond drill bit	Manual MB 1	340 x 450 x 480	20	230 V, 10/16 A	1200	1/2 inch cross section, at least 2 bar fresh water	1,5 L/min (idle running)

1) Supplied with a venturi nozzle #802111

2) Supplied with a vacuum pump #802597



# Drill rig SBN 502

Undercut drilling machines for wet diamond drilling of natural stone and ceramic façade panels.

3

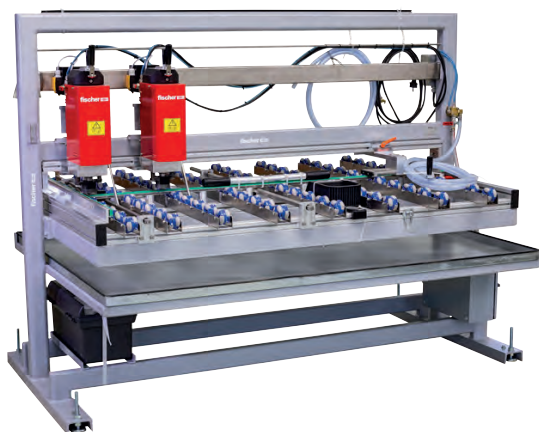

## Advantages

- Easy handling
- Economic creation of undercut drill holes in production
- Compact dimensions

## Functioning

- Diamond drilling
- Water cooling
- Undercutting
- Wet drilling

## Building materials

- Natural stone ( $\geq 20\text{mm}$ )
- Artificial concrete panels
- Ceramics ( $\geq 10\text{ mm}$ )
- Solid-surface materials

## Technical data

Item	Item No.	Useable material	Drill bit	Drilling Technology	Dimensions [cm]	Table skewness [cm]	Weight [kg]	Connections	Power input [W]	Water connection	Water consumption
SBN 502	061500	natural stone, ceramic	Diamond drill bit	Manual MB 2	210 x 140 x 160	170 x 130 x 80	450	230 V, 10/16 A	2 x 1000	1/2 inch cross section, at least 2 bar fresh water	1,5 L/min (idle running)

# Mobile drilling equipment LBT 80

Undercut drilling machines for wet diamond drilling of natural stone and ceramic façade panels.



## Advantages

- Easy handling
- Economic creation of undercut drill holes in reveal panels
- Compact dimensions

## Functioning

- Diamond drilling
- Water cooling
- Undercutting
- Wet drilling

## Building materials

- Natural stone ( $\geq 20\text{mm}$ )
- Artificial concrete panels
- Ceramics ( $\geq 10\text{ mm}$ )
- Solid-surface materials

## Technical data

Item	Item No.	Useable material	Drill bit	Drilling Technology	Dimensions [cm]	Table skewness [cm]	Weight [kg]	Connections	Power input [W]	Water connection	Water consumption
LBT 80	046225	natural stone, ceramic	Diamond drill bit	Manual MB 2	72 x 80 x 142	40 x 80 x 75	65	230 V, 10/16 A	1000	1/2 inch cross section, at least 2 bar fresh water	1,5 L/min (idle running)



# Manual drill head MB 2

Undercut drilling machines for mounting on existing processing lines for wet drilling of facade panels made of natural stone and ceramics.



3

## Advantages

- easy attachment with a flange plate
- smallest drilling unit from fischer with the advantages of the big machines
- possibility of individual solutions

## Functioning

- Diamond drilling
- Water cooling
- Undercutting
- Wet drilling
- Vacuum

## Building materials

- Natural stone ( $\geq 20\text{mm}$ )
- Artificial concrete panels
- Ceramics ( $\geq 10\text{ mm}$ )
- Solid-surface materials

## Technical data

Item	Item No.	Useable material	Drill bit	Drilling Technology	Dimensions [mm]	Weight [kg]	Connections	Power input [W]	Water consumption
MB 2	061130	natural stone, ceramic	Diamond drill bit	Manual MB 2	190 x 290 x 600	30	230 V, 10/16 A	1000	1,5 L/min (idle running)

# Mobile drilling equipment BSN 101T

Drilling system for dry drilling using carbide cutters in façade panels, such as HPL and fibre cement.



## Advantages

- Easy handling
- Economic construct undercut drill holes
- Compact dimensions

## Functioning

- Carbide drilling fraises
- Dry drilling
- Undercutting
- Vacuum

## Building materials

- Fibre cement
- HPL panels
- Thin panel materials ( $\geq 8$  mm)

## Technical data

Item	Item No.	Useable material	Drill bit	Drilling Technology	Dimensions [mm]	Weight [kg]	Connections	Power input [W]
BSN 101T	802484 <sup>1)</sup>	Thin panel materials (e. g. HPL, fibre cement)	Carbide cutters	Manual MB 1	280 x 530 x 520	15	230 V, 10/16 A	1200

1) Supplied with one venturi nozzle #802111. Additionally a vacuum pump #802597 can be purchased.



# Side table BST

Supporting tables for drilling machines.

3



## Advantages

- Improves operating comfort
- Work with larger panel formats
- Enlarges the machine table surface

## Technical data



BST 80

BST 502

Item	Item No.	Dimensions [mm]	Weight [kg]	Number of rollers	Max. load (carrier roller) [N]	Suitable for machine type
BST 80	046228	800 x 480 x 780 (B x H x T)	20	5 pcs. Ø 50 x 390 mm	200	LBT 80
BST 502	046235	1000 x 1250 x 830 (B x H x T)	50	55 pcs. Ø 60 mm	200	SBN 502

# Machine accessories

Accessories for fischer undercut drilling machines.

## Vacuum pump VP



3

Item	Item No.	For machine type	Dimensions [mm]	Weight [kg]	Technical details
Vacuum pump VP	802597	BSN 100, BSN 101 T	230 x 210 x 280 (B x T x H)	11	850 W, 230 V, 3,5 A, 50-60Hz

## Venturi nozzle VD



Item	Item No.	For machine type	Dimensions [mm]	Weight [kg]	Technical details
Venturi nozzle VD	802111	BSN 100, BSN 101 T	120 x 60 x 20 (B x T x H)	0,1	

## Vacuum cleaner SSG



Item	Item No.	For machine type	Dimensions [mm]	Weight [kg]	Technical details
Vacuum cleaner SSG	802596	BSN 101 T	350 x 400 x 350 (B x T x H)	4	500 W, 230 V, 1,9-2,2 A, 60 Hz

# Drill bits

to ensure correct undercut drill hole geometry for fischer Zykon panel anchors.

Different materials require different types of drill bits. The appropriate drilling tool must be selected for each material and anchor combination. For example, a diamond drill bit with water cooling is used for natural

stone or ceramic panels. With carbide cutters, many other materials such as HPL and fibre cement can be drilled dry, without the need for water cooling.

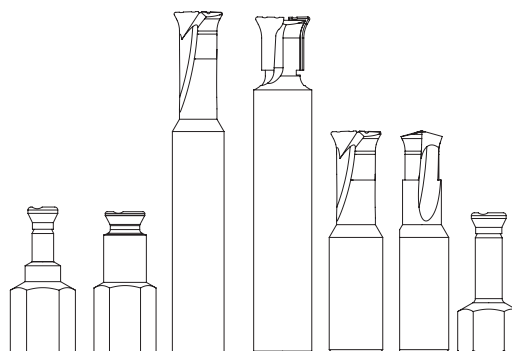



# Undercut drill bits

Undercut drill bit for façade panels.



## Applications

- Interior façades
- Exterior façades
- Façade reveals

## Versions

- Diamond drill bit
- Carbide drill bit

## Advantages

- Simple creation of undercut drill holes for fischer-Zykon panel anchors.

## Building materials

- Natural stone ( $\geq 20\text{mm}$ )
- Artificial concrete panels
- Ceramics ( $\geq 10\text{ mm}$ )
- Solid-surface materials
- Fibre cement
- HPL panels
- Solid surfaces
- Thin panel materials ( $\geq 8\text{ mm}$ )

## Technical data



FZPB

FZPB 11/28

FZPB 11T D12

Item	Item No.	Useable material	Drilling method	for BSN 100 VD & VP	for SBN 502 & LBT 80	for BSN 100T	Drill depth
							$h_0$ [mm]
FZPB 9	060713	Natural stone	wet	—	FZP II M6	—	16
FZPB 9T	530910	ceramic	wet	—	FZP II T D40	—	16
FZPB 11	060710	Natural stone	wet	FZP II M6	FZP II M8, FZP II M6i	—	21
FZPB 11/28	092880	Natural stone	wet	FZP II M6	FZP II M8, FZP II M6i	—	28
FZPB 13	060711	Natural stone	wet	FZP II M8, FZP II M6i	FZP II M8i	—	21
FZPB 15	530908	Natural stone	wet	—	—	—	21
FZPB 11T D12	522402	Thin panel materials (e. g. HPL, fibre cement)	dry	—	—	FZP II T	10

# Undercut drill bits CNC

Creation of undercut holes for anchors using a CNC process.

3



## Applications

- Interior façades
- Exterior façades
- Façade reveals

## Versions

- Helix drilling
- Single stage, direct drilling
- Two-stage, direct drilling with pre-drilling

## Advantages

- Low investment costs
- Fast implementation of fischer undercut technology

## Building materials

- Natural stone ( $\geq 20\text{mm}$ )
- Artificial concrete panels
- Ceramics ( $\geq 10\text{ mm}$ )
- Solid-surface materials
- Fibre cement
- HPL panels
- Solid surfaces
- Thin panel materials ( $\geq 8\text{ mm}$ )

## Technical data



FZPB



FZPB CNC DIA

Item	Item No.	Useable material	Drilling method	for CNC + adapter	Drill depth $h_0$ [mm]
FZPB 11/21 CNC	535984 <sup>1)</sup>	natural stone, ceramic	wet	FZP II M6, FZP II T D40	21
FZPB 11/28 CNC	530911 <sup>1)</sup>	Natural stone	wet	FZP II M6	28
FZPB 13/21 CNC	535985 <sup>1)</sup>	Natural stone	wet	FZP II M8, FZP II M6i	21
FZPB 13/38 CNC	540698 <sup>1)</sup>	Natural stone	wet	FZP II M8, FZP II M6i	38
FZPB 15/28 CNC	547077 <sup>1)</sup>	Natural stone	wet	FZP II M8i	28
FZPB 11T CNC	522398	Thin panel materials (e. g. HPL, fibre cement)	dry	FZP II T	10
FZPB 11T CNC-DIA	541464	Thin panel materials (e. g. HPL, fibre cement)	dry	FZP II T	10
CNC adapter	804063	natural stone, ceramic	wet	FZP II M6, FZP II M8, FZP II M6i, FZP II M8i	—

<sup>1)</sup> if necessary the fischer CNC adapter #804063 (machine side: R 1/2°-60°; drill bit side M14 thread) may be required

# Undercut drill bits glass

Creation of undercut holes in glass.



## Applications

- Glass façades
- Interior façades
- Exterior façades

## Versions

- Helix drilling

## Advantages

- Creation of undercut drill holes for Fischer Zykon panel anchors in glass..

## Building materials

- Single layer safety glass ( $\geq 10\text{mm}$ )
- Laminated composite safety glass ( $\geq 18\text{mm}$ )
- Glas ceramic

## Technical data



FZPB G

Item	Item No.	Useable material	Drilling method	for CNC + adapter	Drill depth $h_0$ [mm]
FZPB 13 G6	019265	glass	wet	FZP G Z ESG, FZP G Z VSG	6
FZPB 13 G7	019266	glass	wet	FZP G Z ESG, FZP G Z VSG	7



# Testing and measuring equipment

for quality control of undercut holes for fischer Zykon panel anchors.

The safe and reliable function of the fixing system depends on various factors. An essential requirement is correctly drilled anchor holes and their quality control. The drill holes should be checked and recorded according

to the testing and setting guidelines as stipulated in the general technical approval.

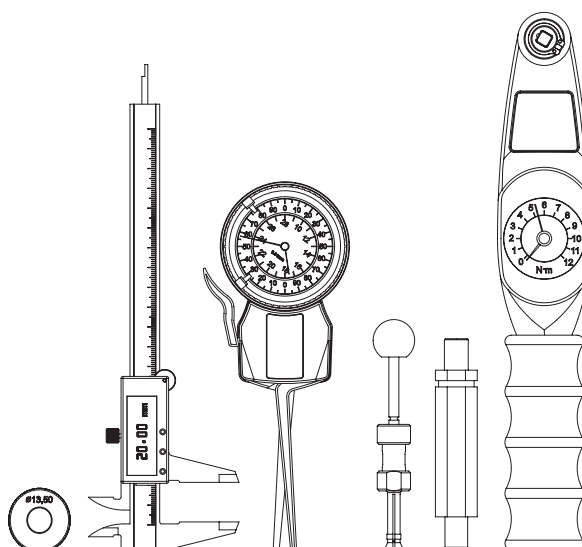

# Testing and measuring equipment

Quality controlling for undercut drill holes.

## Dial gauge for measuring the undercut diameter



Dial gauge STU

Item	Item No.	Useable material	FZP II M6	FZP II M8	FZP II M6 T	FZP II M6 T D40	FZP II M6i	FZP II M8i	FZP-G ESG	FZP-G VSG
STU 10 - 30	802506	all	●	●	●	●	●	●	●	●

## Caliper for the measuring of the depth and cylindrical diameter of the drill hole



Analog caliper MST

Digital caliper MST-D

Item	Item No.	Useable material	FZP II M6	FZP II M8	FZP II M6 T	FZP II M6 T D40	FZP II M6i	FZP II M8i	FZP-G ESG	FZP-G VSG
MST	802575	all	●	●	●	●	●	●	●	●
MST-D	802507	all	●	●	●	●	●	●	●	●

## Undercut volume gauge for checking the minimum undercut volume



Undercut volume gauge HVL

Item	Item No.	Useable material	FZP II M6	FZP II M8	FZP II M6 T	FZP II M6 T D40	FZP II M6i	FZP II M8i		
HVL 11	802333	natural stone, ceramic	●	—	—	●	—	—		
HVL 11T	802732	Fibre cement	—	—	●	—	—	—		
HVL 13	802337	Natural stone	—	●	—	—	●	—		
HVL 15	804186	Natural stone	—	—	—	—	—	●		

### Diameter gauge for checking the cylindrical drill hole diameter



Diameter gauge DPL

Item	Item No.	Useable material	FZP II M6	FZP II M8	FZP II M6 T	FZP II M6 T D40	FZP II M6i	FZP II M8i		
DPL 11	802339	natural stone, ceramic	●	—	—	●	—	—		
DPL 11T	804089	Fibre cement	—	—	●	—	—	—		
DPL 13	802338	Natural stone	—	●	—	—	●	—		
DPL 15	804184	Natural stone	—	—	—	—	—	●		

3

### Accessories



Torque wrench DMS



Adjustment ring ESR

Item	Item No.	Useable material	FZP II M6	FZP II M8	FZP II M6 T	FZP II M6 T D40	FZP II M6i	FZP II M8i	FZP-G ESG	FZP-G VSG
DMS 0,5 - 13,5 Nm	102863	all	●	●	●	●	●	●	●	●
ESR 13,5 - 15,5	802543	all	●	●	●	●	●	●	●	●





# Setting tools

for proper installation of fischer Zykon panel anchors.

The setting tools complete the overall fischer Zykon panel anchor fixing system. Based on years of experience, coordinated and revised with our customers, fischer offers a range of high-quality tools for simple,

fast and safe installation of the FZP II anchors. This is carried out according to the general technical approval relevant to the anchor and panel material combination.

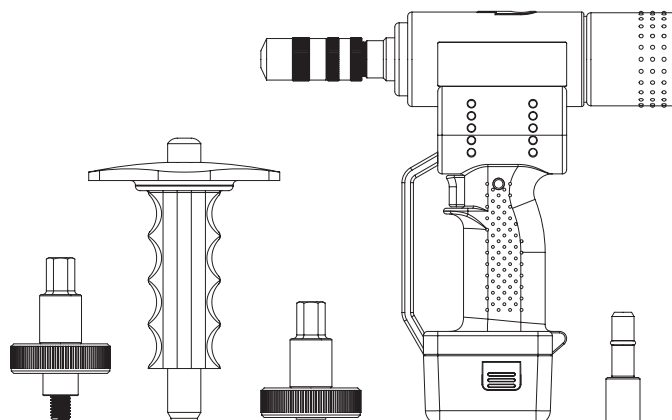



# Setting tools

Installation of fischer Zykon panel anchors FZP II.

## Setting tools



Battery operated setting tool SGB



Manual setting tool SGT

Item	Item No.	Useable material	FZP II M6	FZP II M8	FZP II M6 T	FZP II M6 T D40	FZP II M6i	FZP II M8i
SGB/110V	804097 <sup>1)</sup>	Natural stone, thin panel materials (e. g. HPL, fibre cement)	●	●	●	●	●	●
SGB/230V	802522 <sup>1)</sup>	Natural stone, thin panel materials (e. g. HPL, fibre cement)	●	●	●	●	●	●
SGT	802669 <sup>2)</sup>	Natural stone, thin panel materials (e. g. HPL, fibre cement)	●	—	●	●	●	—

1) Dangerous goods - no express shipping possible.

2) for max. thread projection 16 mm

## Setting adapter



Setting adapter SGA M8



Setting adapter SGA M8i

Item	Item No.	Useable material	FZP II M6	FZP II M8	FZP II M8i	FZP II M6 T	FZP II M6 T D40	FZP-G ESG	FZP-G VSG
SGA-M6	803749 <sup>1)</sup>	natural stone, ceramic	●	—	—	●	●	—	—
SGA-M8	803748 <sup>1)</sup>	Natural stone	—	●	—	—	—	●	●
SGA-M8i	804432	Natural stone	—	—	●	—	—	—	—

1) for max. thread projection 18 mm

## Setting tool FZE plus



Setting tool FZE plus

Item	Item No.	Useable material	FZP II M6	FZP II M6i	FZP II M8	FZP II M8i
FZE 10 plus	044637 <sup>1)</sup>	Natural stone	●	●	—	—
FZE 12 plus	044638	Natural stone	—	—	●	—
FZE 14 plus	044639	Natural stone	—	—	—	●

1) Without centring pin.







# 4

## SystemOne subframe system

---

Horizontal profiles

74

Clasps

75

Vertical profiles

77

Wall holder

79

Accessories

81



# Subframe systems

SystemOne, SystemOne Light and SystemOne Vertical Solutions.

## SystemOne

A key element of fischer façade systems is the SystemOne subframe. It is designed for high loads, large-sized, heavy natural stone slabs and for bridging non-load-bearing building structures. The subconstruction reduces assembly times on-site, reduces noise, e.g. during renovations, and allows easy replacement of panels. The combination of horizontal profiles and panel clasps results in a constant construction dimension of 37 mm.



## SystemOne Light

The fischer SystemOne Light façade system is the efficient solution when it comes to fast installation of rainscreen facades made of lightweight façade panels. The combination of horizontal profiles and panel clasps results in a constant construction dimension of 25 mm.



## SystemOne Vertical Solution

A purely vertical subconstruction can be implemented with the fischer SystemOne Vertical Solution. With this system, the loads are transferred directly via the panel clasps mounted on the vertical profiles. For this system, the special Zykon FZP II VS panel anchors are used, which, thanks to the suspension nut, are hooked into the clasps according to the key lock principle. The use of the vertical solution results in a constant construction dimension of 15 mm.

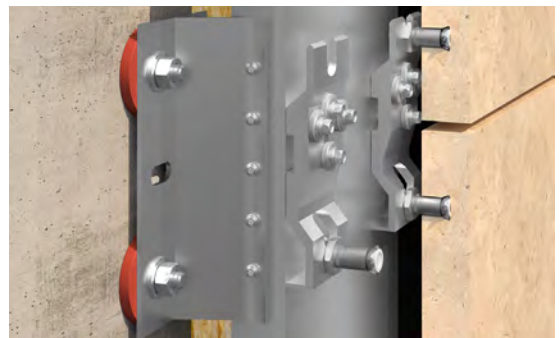





La Grande Arche - Paris - France

# Horizontal profiles

## Horizontal profile Bracket Solution

4



SystemOne in façade cross section with natural stone



SystemOne Light in façade cross section with natural stone

### Applications

- As a horizontal profile for subframe systems in rainscreen facades

### Versions

- HP BS
- HP BSL

### Advantages

- Horizontal load bearing and transfer to the vertical profiles
- Quick and easily suspend façade panels thanks to the coordinated geometries of the brackets and horizontal profiles

### Functioning

- Geometric coordination
- Horizontal load transfer

### Technical data

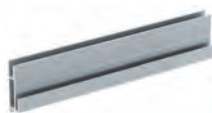

HP-BSL

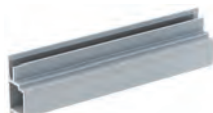

HP-BS

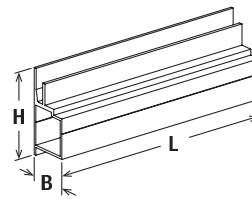
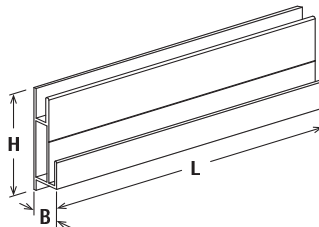

Item	Item No.	Length L [mm]	Width B [mm]	Height H [mm]	Sales unit [pcs]
HP-BSL	018438	6000	21	64	1
HP-BS	048899	6000	34	74	1

# Clasps

## Clasps Bracket Solution



SystemOne in façade cross section with natural stone

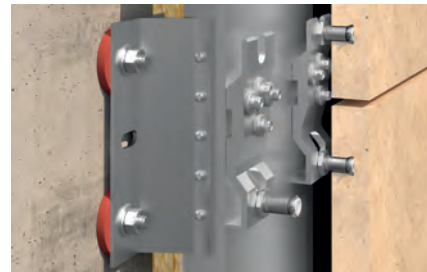

SystemOne Vertical Solution in façade cross section with natural stone

4

### Applications

- As a suspension element in the horizontal profile for subframe systems in rainscreen façades.

### Versions

- BR-BS
- BR-BSL
- BR-VS

### Advantages

- Clasps can be pre-assembled, saving time on the construction site.
- Fast and easy installation of façade panels thanks to the coordinated geometries of the clasps and horizontal profiles.

### Functioning

- Geometric coordination
- Load bearing

### Technical data



BR-BS

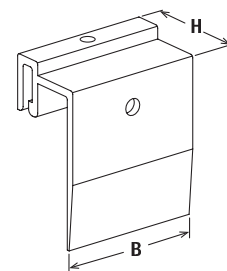

Item	Item No.	Width B [mm]	Height H [mm]	Sales unit [pcs]
BR-BS M6/50	048904	50	30	250
BR-BS M6/100	091536	100	30	125
BR-BS M8/50	049238	50	30	250
BR-BS M8/100	078585	100	30	125
BR-BS M8/150	078587	150	30	100



### Technical data



BR-BSL

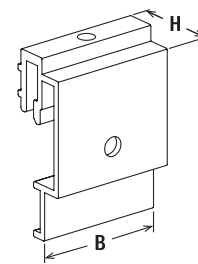

4

Item	Item No.	Width B [mm]	Height H [mm]	Sales unit [pcs]
BR-BSL 40-M6	018439	40	18	250
BR-BSL 40-M8	018448	40	18	250
BR-BSL 90-M8	018447	90	18	200

### Technical data



BR-VS

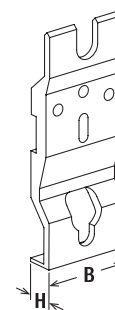

Item	Item No.	Width B [mm]	Height H [mm]	Sales unit [pcs]
BR-VS 50-S	521663	50	15	20
BR-VS 50-F	521662	50	15	20

# Vertical profiles

## Box-section vertical profile

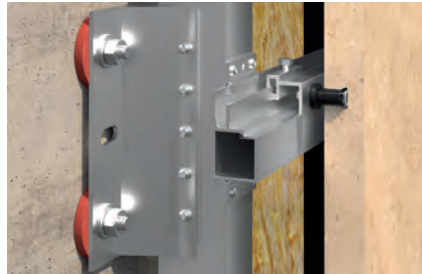

SystemOne in façade cross section with natural stone

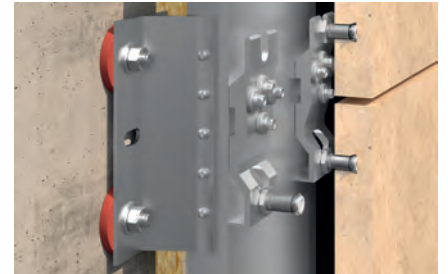

SystemOne Vertical Solution in façade cross section with natural stone

4

### Applications

- As a vertical profile for subframe systems in rainscreen facades

### Versions

- VP
- T

### Advantages

- Vertical box sections are better suited to absorb higher loads than T- or L-profiles, thanks to their closed geometry.
- Better resistance to torsion.
- Tolerance compensation for the substrate.
- Simple geometry.

### Functioning

- Vertical load transfer
- Tolerance compensation

### Technical data



VP

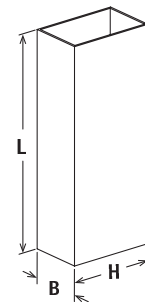

Item	Item No.	Length L [mm]	Width B [mm]	Height H [mm]	Sales unit [pcs]
VP 25/2	018441	6000	50	25	1
VP 30/2	077545	6000	50	30	1
VP 40/2	077546	6000	50	40	1
VP 50/2	048895	6000	50	50	1
VP 80/2	048896	6000	50	80	1
VP 100/2	048897	6000	50	100	1
VP 120/3	048898	6000	50	120	1
VP 150/3	097884	6000	50	150	1
VP 180/3	097885	6000	50	180	1

Technical data



T60

T110

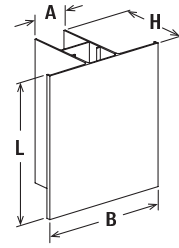
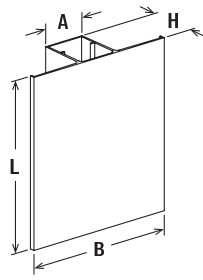

4

Item	Item No.	Length L [mm]	Width A A [mm]	Width B [mm]	Height H [mm]	Sales unit [pcs]
T60	077692	6000	50	180	60	1
T110	509279	6000	50	180	110	1



# Wall brackets

Wall holder with fixing points on both sides

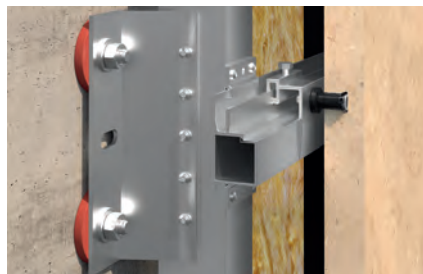

SystemOne in façade cross section with natural stone

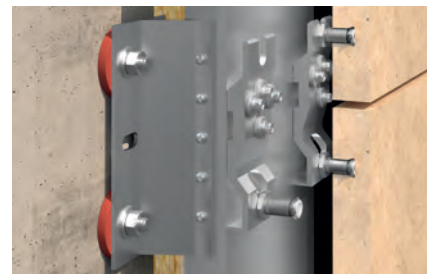

SystemOne Vertical Solution in façade cross section with natural stone

4

## Applications

- As a wall holder for subframe systems in rainscreen facades

## Versions

- FPH
- SPH

## Advantages

- The wall holder is used to absorb and transfer the loads applied to the façade system.
- They compensate the tolerance of the substrate.
- Available as fixed and sliding point anchors.
- Absorption of thermal longitudinal expansion through slots on the sliding point anchor.

## Functioning

- Vertical load transfer.
- Absorption of higher loads through double-sided attachment.
- Tolerance compensation for structural tolerances.
- Easy installation with attachments on both sides.

## Technical data



FPH

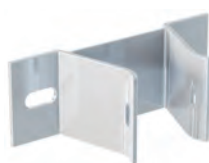

SPH

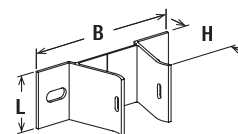
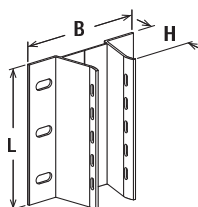

Item	Item No.	Length L [mm]	Width B [mm]	Height H [mm]	Slot l x s [mm]	Match	Sales unit [pcs]
FPH 30	018442	180	140	30	11 x 25	VP 50, VP 100	40
FPH 54	018444	180	160	54	11 x 25	VP 50, VP 100	40
FPH 68	048900	180	160	68	11 x 25	VP 50, VP 100	30
FPH 93	048901	180	160	93	11 x 25	VP 50, VP 100	20
FPH 133	030367	180	160	133	11 x 25	VP 50, VP 100	24
SPH 30	018443	60	140	30	11 x 25	VP 50, VP 100	100
SPH 54	018445	60	160	54	11 x 25	VP 50, VP 100	100
SPH 68	048902	60	160	68	11 x 25	VP 50, VP 100	90
SPH 93	048903	60	160	93	11 x 25	VP 50, VP 100	75
SPH 133	030368	60	160	133	11 x 25	VP 50, VP 100	50

# Installation accessories

for the installation of fischer rainscreen façade systems.

The installation accessories include all components and elements which are required to assemble fischer façade systems as a rainscreen façade.

In addition to the usual fixings and connectors such

as screws, rivets and nuts, accessories for sub-frame systems and reveal angles for the design of façade corners are included.

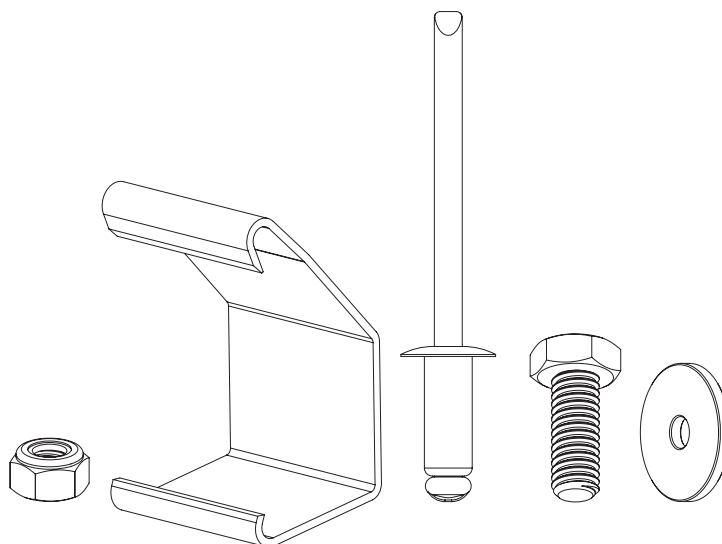

# Accessories

Diverse assortment of accessories for installing a subframe system

## Reveal angle LW

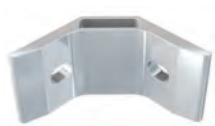

LW 50

Item	Item No.	Material	Adapted for	Length L [mm]	Height H [mm]	Width B [mm]	Material thickness [mm]	Angle	Slot l x s [mm]	Sales unit [pcs]
LW 50-M6	078995	Aluminium	FZP II M6, FZP II M6 Carbon	80	80	50		90°	9 x 15	125
LW 50-M8	079148	Aluminium	FZP II M8, FZP II M8 Carbon	80	80	50		90°	11 x 17	125

## Profile guidance GLB



GLB

Item	Item No.	Material	Adapted for	Length L [mm]	Height H [mm]	Material thickness [mm]	Sales unit [pcs]
Profile guidance GLB	048906	PVC		50	27	3	200

## Fixit Plastic wedge to form a horizontal fixed point



Fixit

Item	Item No.	Material	Length L [mm]	Height H [mm]	Material thickness [mm]	Sales unit [pcs]
Fixit	048905	PVC	45	20		250



**HP-Clip = visual protection clip to cover the aluminium substructure in the panel joints**

HP-Clip

Item	Item No.	Material	Length L [mm]	Height H [mm]	Width B [mm]	Material thickness [mm]	Sales unit [pcs]
Cover plate HP-Clip	096451	PVC	70	40	45	2	300

**Thermal isolator CBS**

Cold bridge stop CBS

Item	Item No.	Material	External-Ø d [mm]	Internal diameter D [mm]	Material thickness [mm]	Sales unit [pcs]
Cold Bridge Stopp CBS	092680	PVC	50	12,0	5	200

**Strip holder bracket solution**

SH-BS

Item	Item No.	Material	Length L [mm]	Height H [mm]	Material thickness [mm]	Sales unit [pcs]
Strip holder bracket solution	079169	Aluminium	120	50	4	50

**Blind rivet**

Blind rivet A4

Item	Item No.	Material	External-Ø d [mm]	Length L [mm]	Sales unit [pcs]
Blind rivet 4.8 x 12 A4	521664	A4	4.8	12	500

## Façade self-tapping screw FABSA



Self-Drilling screw FABSA  
23-A2

Item	Item No.	Material	External-Ø d [mm]	Diameter of washer [mm]	Length L [mm]	Sales unit [pcs]
FABSA 23 5,5 x 38 A2 DS16	092379		5.5	16	38	500

## Façade screw FADI



Facade self-tapping screw  
FADI A-A2

Item	Item No.	Material	External-Ø d [mm]	Diameter of washer [mm]	Length L [mm]	Sales unit [pcs]
FADI A 6,5 x 32 A4 DS16	092123	A4	6.5	16	32	500

## Washer



Washer

Item	Item No.	Material	Internal diameter D [mm]	Width across nut SW [mm]	Height H [mm]	DIN	Sales unit [pcs]
Washer M6-A4	523231	A4	6	10	1.6	125	100
Washer M8-A4	523232	A4	8	13	1.6	125	100

## Spike washer

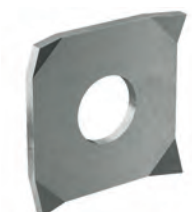

Spike washer A4

Item	Item No.	Material	Internal diameter D [mm]	Length L [mm]	Height H [mm]	Material thickness [mm]	Sales unit [pcs]
Spike washer M6 - A4	049914	A4	6	20	20	3	100
Spike washer M8 - A4	049915	A4	8	20	20	3	100

## Nut A4



Hexagonal nut A4

Lock nut A4

Serrated Nut A4

Item	Item No.	Material	Internal thread A1	Width across nut SW [mm]	Height H [mm]	DIN		Sales unit [pcs]
Nut M6 A4	521667	A4	M 6	10	5.2	934	24 032	100
Nut M8 A4	521668	A4	M 8	13	6.8	934	24 032	100
Lock nut M6 A4	521669	A4	M 6	10	8	985	24 032	100
Lock nut M8 A4	521670	A4	M 8	13	9.5	985	24 032	100
Serrated Nut M6 A4	541613	A4	M 6	10	6	1661	6923	250
Serrated Nut M8 A4	541614	A4	M 8	13	8	1661	6923	250

## Screw locking liquid



Screw locking liquid

Item	Item No.	Contents [ml]	Sales unit [pcs]
Screw locking liquid 10ml	521676	10	1

## Profile connector



PSV-BS

PSV-BSL

PSV-VS

Item	Item No.	Material	Length L [mm]	Height H [mm]	Width B [mm]	Material thickness [mm]	Sales unit [pcs]
PSV-BS	521665	Aluminium	200	30	30	2	25
PSV-BSL	018446	Aluminium	200	35	10	2	25
PSV-VS	049905	Aluminium	200	45	20	2	50



## Adjustment screw



ES-BS

Item	Item No.	Material	External-Ø d [mm]	Width across nut SW [mm]	Length L [mm]	DIN	Sales unit [pcs]
ES-BS	521673	A4	6	10	16	933	50
ES-BSL	521672	A4	6	10	14	933	50

## Adjustable wedge



Adjustable wedge

Item	Item No.	Material	Sales unit [pcs]
Adjustable wedge VS	521675	PVC	5

## Socket wrench



Socket wrench with T-handle

Item	Item No.	Internal thread A1	Width across nut SW [mm]	Sales unit [pcs]
Socket wrench SW10	802168	M 6	10	1
Socket wrench SW13	802169	M 8	13	1

## Rivet setting tool



NSG

Item	Item No.	Sales unit [pcs]
NSG (price)	046236 <sup>1)</sup>	1

1) Dangerous goods - no express shipping possible.





5





City-Hall · Taichung · Taiwan



# 5

## Fixing systems and accessories

---

Steel fixings	88	
Chemical fixings	89	
Frame fixings	93	
Insulation fixings	94	
Power tools	96	

---



# Steel fixings

Mechanical anchoring solutions for heavy loads

## Technical data



Bolt anchor FAZ II

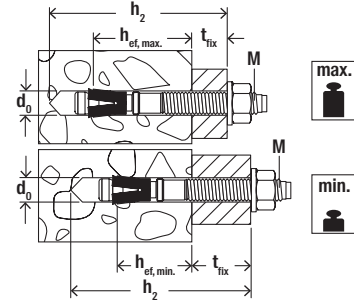

5

Item	Zinc-plated steel	Stainless steel	Approval		Seismic-Approval	Drill hole diameter $d_0$ [mm]	Min. drill hole depth for through fixings $h_2$ [mm]	Max. usable length hef,max./ hef,min. $t_{fix}$ [mm]	Anchor length $l$ [mm]	Thread $\emptyset$ x length [mm]	Width across nut SW [mm]	Sales unit [pcs]
	Item No. gvz	Item No. R	ETA	ICC								
FAZ II 8/10	094871 <sup>1)</sup>	501396 <sup>1)</sup>	●	●	C1	8	65	10/20	75	M 8 x 38	13	50
FAZ II 10/10	094981	501403	●	●	C1 / C2	10	85	10/30	95	M 10 x 53	17	50
FAZ II 10/20	094982	—	●	●	C1 / C2	10	95	20/40	105	M 10 x 63	17	25
FAZ II 10/20	—	501406	●	●	C1 / C2	10	95	20/40	105	M 10 x 63	17	50

<sup>1)</sup> With minimum embedment depth only for statically indeterminate systems

## Technical data



ULTRACUT FBS II US - hexagon head with integral washer

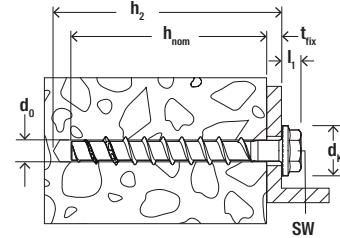

Item	Item No.	Approval	Drill hole diameter $d_0$ [mm]	Min. drill hole depth for through fixings $h_2$ [mm]	Screw $d_a \times l_s$ [mm]	Screw-in depth with fixture thickness $h_{nom1} / t_{fix}$ [mm]	Screw-in depth with fixture thickness $h_{nom2} / t_{fix}$ [mm]	Screw-in depth with fixture thickness $h_{nom3} / t_{fix}$ [mm]	Drive	Sales unit [pcs]
		ETA								
FBS II 8x80 30/15 US TX	536853	●	8	90	10 x 80	50 / 30	65 / 15	65 / 15	TX40/SW13	50
FBS II 8x90 40/25 US TX	536854	●	8	100	10 x 90	50 / 40	65 / 25	65 / 25	TX40/SW13	50
FBS II 8x100 50/35 US TX	536855	●	8	110	10 x 100	50 / 50	65 / 35	65 / 35	TX40/SW13	50
FBS II 10x70 15/5/- US	536859	●	10	80	12 x 70	55 / 15	65 / 5	- / -	SW 15	50
FBS II 10x80 25/15/- US	536860	●	10	90	12 x 80	55 / 25	65 / 15	- / -	SW 15	50
FBS II 10x100 45/35/15 US	536862	●	10	110	12 x 100	55 / 45	65 / 35	85 / 15	SW 15	50

# Chemical fixings

Chemical fixing solutions for heavy-duty fixings in concrete and masonry.

## Technical data



Injection mortar FIS HB 345 S Static mixer FIS MR Plus

Item	Item No.	Approval ETA	Languages on the cartridge	Scale unit	Contents	Sales unit [pcs]
FIS HB 345 S	033211 <sup>1)</sup>	●	DE, EN, FR, ES, NL, CS	180	1 cartridge 360 ml, 2 x FIS MR Plus	6
FIS MR Plus	545853	—	—	—	10 static mixer FIS MR Plus	10

1) incl. 2 static mixer per cartridge.

## Technical data



FHB II-P 10 x 60

FHB II-PF 10 x 60

Item	Item No.	Approval ETA	Drill hole diameter $d_0$ [mm]	Drill hole depth $h_0$ [mm]	Anchorage depth $h_{ef}$ [mm]	Match	Sales unit [pcs]
FHB II-P 10 x 60	096847	●	10	75	60	FHB II-S M 10 x 60	10
FHB II-PF 10 x 60	500547	●	10	75	60	FHB II-S M 10 x 60	10

## Technical data



Highbond anchor FHB II-A S  
(short version)

Item	Zinc-plated steel	Stainless steel	Highly corrosion resistant steel	Approval ETA	Drill hole diameter	Drill hole depth	Anchorage depth	Usable length	Thread M	Width across nut	Sales unit [pcs]
	Item No. gvz	Item No. R	Item No. HCR		$d_0$ [mm]	$h_0$ [mm]	$h_{ef}$ [mm]	$t_{fix}$ [mm]		SW [mm]	
FHB II-A S M10 x 60/10	097072	097630	097704 <sup>1)</sup>	●	10	75	60	10	M 10	17	10
FHB II-A S M10 x 60/20	097073	097631	097705 <sup>1)</sup>	●	10	75	60	20	M 10	17	10

1) Delivery time on request.

## Technical data



Injection mortar FIS V 360 S    Static mixer FIS MR Plus

Item	Item No.	Approval			Languages on the cartridge	Scale unit	Contents	Sales unit [pcs]
		DIBt	ETA	ICC				
FIS V 360 S	094404	●	●	●	DE, FR, NL, TR, HU, AR	180	1 cartridge 360 ml, 2 x FIS MR Plus	6
FIS V 360 S	094405	●	●	●	EN, IT, PT, ES, ZH, JA	180	1 cartridge 360 ml, 2 x FIS MR Plus	6
FIS V 360 S	068435	●	●	●	DA, SV, NO, FI, PL, EL	180	1 cartridge 360 ml, 2 x FIS MR Plus	6
FIS V 360 S	043994	●	●	●	CS, SK, PL, HU, RO, RU	180	1 cartridge 360 ml, 2 x FIS MR Plus	6
FIS V 360 S	502283	●	●	●	LT, LV, ET, UK, RU, KK	180	1 cartridge 360 ml, 2 x FIS MR Plus	6
FIS MR Plus	545853	—	—	—	—	—	10 static mixer FIS MR Plus	10

## Technical data in concrete



Threaded rod FIS A

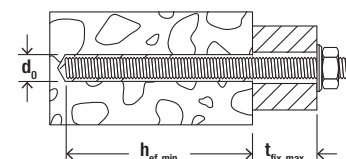

Item	Zinc plated, steel grade 5.8	Stainless steel	Approval		Drill hole diameter $d_0$ [mm]	Min. / max. anchorage depth [mm]	Min. / max. usable length [mm]	Min. / max. filling quantity [scale units]	Sales unit [pcs]
	Item No. gvz	Item No. R	ETA	ICC					
FIS A M 10 x 110	090278	090444	●	●	12	60 / 96	1 / 37	3 / 4	10

## Technical data in solid brick masonry



Threaded rod FIS A

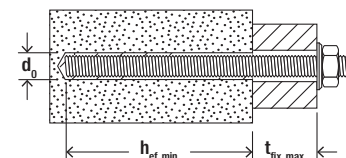

Item	Zinc plated, steel grade 5.8	Stainless steel	Approval		Drill hole diameter $d_0$ [mm]	Min. effective anchorage depth acc. ETA [mm]	Max. effective length acc. ETA [mm]	Fill quantity for effect. anchoring depth [scale units]	Sales unit [pcs]
	Item No. gvz	Item No. R	ETA	ICC					
FIS A M 10 x 110	090278	090444	●		12	50	30	3	10



### Technical data in perforated brick masonry



Threaded rod FIS A

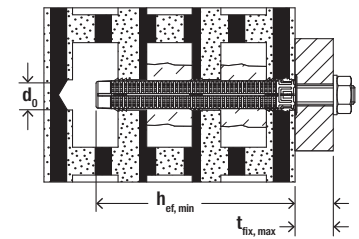

Item	Zinc plated, steel grade 5.8 Item No. gvz	Stainless steel Item No. R	Approval ETA	Drill hole diameter in perforated brick masonry $d_0$ [mm]	Min. anchorage depth in perforated brick masonry $h_{ef, min}$ [mm]	Max. useful length in perforated brick masonry $t_{fix, max}$ [mm]	Suitable injection anchor sleeve	Sales unit [pcs]
FIS A M 10 x 110	090278	090444	●	16	85	12	FIS H 16 x 85 K	10

5

### Technical data in undercut drill hole in aerated concrete



Threaded rod FIS A

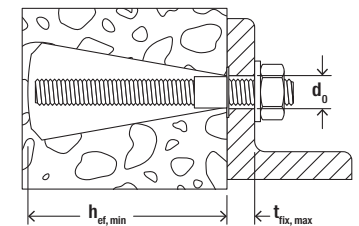

Item	Zinc plated, steel grade 5.8 Item No. gvz	Stainless steel Item No. R	Approval ETA	Drill hole diameter in aerated concrete in undercut drill hole [mm]	Min. / max. anchorage depth in aerated concrete in undercut drill hole $h_{ef}$ [mm]	Min. / max. usable length in aerated concrete $t_{fix}$ [mm]	Filling quantity for min. / max. anchorage depth in aerated concrete [scale units]	Sales unit [pcs]
FIS A M 10 x 110	090278	090444	●	14	75 / 95	22 / 2	15 / 20	10

### Technical data in cylindrical drill hole in aerated concrete



Threaded rod FIS A

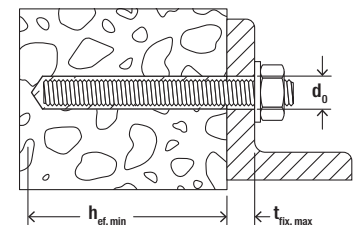

Item	Zinc plated, steel grade 5.8 Item No. gvz	Stainless steel Item No. R	Approval ETA	Drill hole diameter in aerated concrete in cylindrical drill hole $d_0$ [mm]	Anchorage depth in aerated concrete in cylindrical drill hole $h_{ef}$ [mm]	Usable length $t_{fix}$ [mm]	Fill quantity for effect. anchorage depth in aerated concrete [scale units]	Sales unit [pcs]
FIS A M 10 x 110	090278	090444	●	12	100	—	—	10

## Technical data



Injection push-through anchor sleeve FIS HK

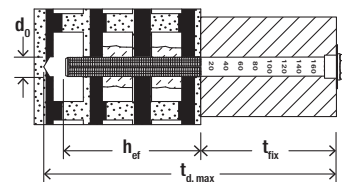

Item	Item No. gvz	Approval ETA	Drill hole diameter $d_0$ [mm]	Max. drill hole depth [mm]	Effect. anchor- age depth $h_{ef}$ [mm]	Max. fixture thickness $t_{fix}$ [mm]	Match	Fill quantity [scale units]	Sales unit [pcs]
FIS H 16 x 85 K	041902	●	16	95	85	—	FIS A M8-M10, FIS E M6-M8	—	50

5

## Technical data



Cone drill PBB



Centring sleeve PBZ

Item	Item No.	Approval ETA	Match	Contents	Sales unit [pcs]
Cone drill PBB	090634	●	M8 - M12; FIS E	1x cone drill PBB	1
Centring sleeve PBZ	090671	●	M8 - M12; FIS E	10x centring sleeve PBZ, 5x injection adapter	10

# Frame fixings

Secure fixing for façade substructures, interior fittings, window and door installation and timber construction

## Technical data



SXRL-FUS - with fischer hexagon head safety screw, moulded washer and integrated bit recess

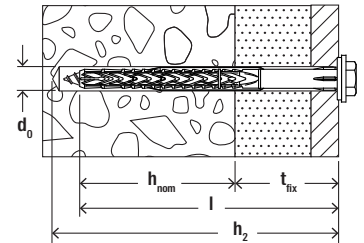

5

Item	Zinc-plated steel	Stainless steel	Approval		Drill diameter	Min. drill hole depth for through fixings	Usable length at anchorage depth 50mm	Usable length at anchorage depth 70mm	Usable length at anchorage depth 90mm	Anchor length	Drive	Sales unit
	Item No. gvz	Item No. A4	ETA	ICC	d <sub>0</sub> [mm]	h <sub>2</sub> [mm]	t <sub>fix</sub> [mm]	t <sub>fix</sub> [mm]	t <sub>fix</sub> [mm]	l [mm]		[pcs]
SXRL 10 x 80 FUS	522719	522730	●	●	10	90	30	10	—	80	T40/SW13	50
SXRL 10 x 100 FUS	522720	522731	●	●	10	110	50	30	10	100	T40/SW13	50
SXRL 10 x 120 FUS	522721	522732	●	●	10	130	70	50	30	120	T40/SW13	50
SXRL 10 x 140 FUS	522723	522733	●	●	10	150	90	70	50	140	T40/SW13	50
SXRL 10 x 160 FUS	522724	522734	●	●	10	170	110	90	70	160	T40/SW13	50

## Technical data



SXR-FUS - with fischer hexagon head safety screw, moulded washer and integrated T40 bit recess

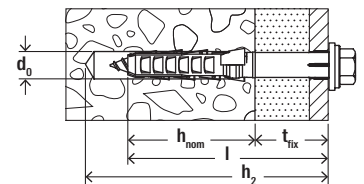

Item	Zinc-plated steel	Stainless steel	Approval	Drill hole diameter	Min. drill hole depth for through fixings	Min. anchorage depth	Anchor length	Max. fixture thickness	Drive	Sales unit
	Item No. gvz	Item No. A4	ETA	d <sub>0</sub> [mm]	h <sub>2</sub> [mm]	h <sub>nom</sub> [mm]	l [mm]	t <sub>fix</sub> [mm]		[pcs]
SXR 10 x 60 FUS	046329	046339	●	10	70	50	60	10	T40/SW13	50
SXR 10 x 80 FUS	046330	046340	●	10	90	50	80	30	T40/SW13	50
SXR 10 x 100 FUS	046331	046342	●	10	110	50	100	50	T40/SW13	50
SXR 10 x 120 FUS	046332	046343	●	10	130	50	120	70	T40/SW13	50
SXR 10 x 140 FUS	046333	046344	●	10	150	50	140	90	T40/SW13	50
SXR 10 x 160 FUS	046334	046345	●	10	170	50	160	110	T40/SW13	50



# Insulation fixings

Fixing elements for fixing insulation boards

## Technical data



Insulation support DHK 45,  
plate- $\varnothing$  45 mm

Insulation support DHK,  
plate- $\varnothing$  90 mm

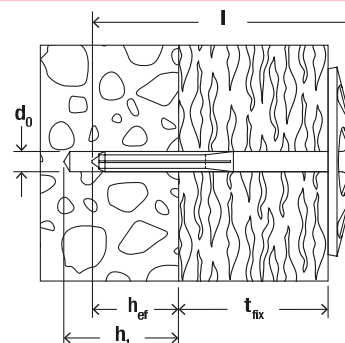

Item	Item No.	Drill hole diameter	Min. drill hole depth	Effect. anchorage depth	Anchor length	Max. fixture thickness	Sales unit [pcs]
		$d_0$ [mm]	$h_1$ [mm]	$h_{ef}$ [mm]	$l$ [mm]	$t_{fix}$ [mm]	
DHK 80	080939	8	30	20	105	80	250
DHK 100	080940	8	30	20	125	100	250
DHK 120	080941	8	30	20	145	120	200
DHK 140	080949	8	30	20	165	140	200
DHK 160	512150	8	30	20	185	160	100
DHK 180	512151	8	30	20	205	180	100
DHK 200	512153	8	30	20	225	200	100
DHK 220	512154	8	30	20	245	220	100

## Technical data



Insulation support metal  
DHM, washer- $\varnothing$  35 mm

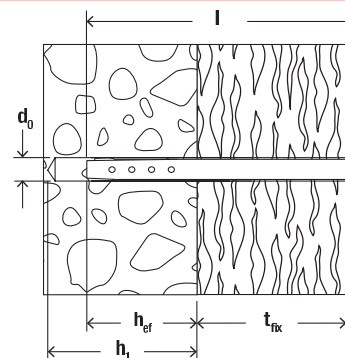

Item	Item No.	Drill hole diameter	Min. drill hole depth	Effect. anchorage depth	Anchor length	Max. fixture thickness	Sales unit [pcs]
		$d_0$ [mm]	$h_1$ [mm]	$h_{ef}$ [mm]	$l$ [mm]	$t_{fix}$ [mm]	
DHM 90	088803 <sup>1)</sup>	8	60	50	140	60 - 90	250
DHM 135	503131 <sup>1)</sup>	8	60	50	185	120 - 135	250
DHM 150	061582 <sup>1)</sup>	8	60	50	200	150	250
DHM 200	519317 <sup>1)</sup>	8	60	50	250	170 - 200	125
DHM 250	519318 <sup>1)</sup>	8	60	50	300	220 - 250	125

<sup>1)</sup> Fixing tapped into aerated concrete G2/G4 without pre-drilling.

## Technical data



HK 36 plastic

HV 36 zinc

ISO-disk 8/60

DT 60/10

DTM-A4

DTM 70/10

5

Item	Item No.	Disc Ø [mm]	Disc height [mm]	Through hole d <sub>f</sub> [mm]	Steel sheet thickness s [mm]	Sales unit [pcs]
HV 36 zinc	004286	36	3,5	5	0,7	100
HK 36 plastic	004283	36	4,5	5	—	100
ISO-disk 8/60	001680	60	7	8	—	100
DT 60/10	044317	60	7	10	—	50
DT 90/4	080957 <sup>1)</sup>	90	9,3	4	—	250
DT 90/8	080958	90	9,3	8,2	—	250
DTM 60/10 A4	088805	60	3	10,5	0,5	100
DTM 70/10 zinc	044318	70	3	10,5	—	50

1) The central hole is adapted in such a way that the disc clamps well on the 4 mm wire of the VB walltie.

# Power tools

Professional electrical devices from a single source.

## Assortment



FSS 18V 400 BL  
- Cordless impact wrench set

FSS 18V 600  
- Cordless impact wrench set

Item	Art.-No.	Belt hook	Sockets [SW]		Test sleeves FUP for concrete screw diameter		Battery pack 4.0 Ah		Charger		Packaging L-Boxx, stackable
		FSS BH	10 / 13 / 15	15 / 17 / 21	8 / 10	12 / 14	1x	2x	Type EU	Type UK	
FSS 18V 400 BL - Set 1	552922	●	●		●						●
FSS 18V 400 BL - Set 2	552924	●	●		●		●				●
FSS 18V 400 BL - Set 3	552926	●	●		●			●	●		●
FSS 18V 400 BL - Set 4	552928	●	●		●			●		●	●
FSS 18V 600 - Set 1	552923	●		●		●					●
FSS 18V 600 - Set 2	552925	●		●		●	●				●
FSS 18V 600 - Set 3	552927	●		●		●		●	●		●
FSS 18V 600 - Set 4	552929	●		●		●		●		●	●

## Accessories



Checking gauge FUP



Nut SW



Nut TX



FMB T40 Maxx Bit



Profi-bit FPB T50 5/16"

Item	Item No.	Internal diameter D [mm]	Drive	Match	Sales unit [pcs]
FUP 8	537200	9,9	—	FBS II 8	1
FUP 10	537201	12,0	—	FBS II 10	1
FUP 12	537202	13,0	—	FBS II 12	1
FUP 14	537203	15,0	—	FBS II 14	1
TX40	538575 <sup>1)</sup>	—	1/2" - 1/4"	FBS II 8 / FBS II 8 SK	1
TX50	538576 <sup>2)</sup>	—	1/2" - 5/16"	FBS II 10 / FBS II 10 SK	1
SW10	538577	—	—	FBS II 6	1
SW13	538578	—	1/2" / SW13	FBS II 8	1
SW15	538579	—	1/2" / SW15	FBS II 10	1
SW17	538580	—	1/2" / SW17	FBS II 12	1
SW21	538581	—	1/2" / SW21	FBS II 14	1
FMB T30 Maxx Bit W 5	533158	—	TX30	FBS II 6	1
FMB T40 Maxx Bit W 5	533159	—	TX40	FBS II 8 / FBS II 8 SK	1
FPB Profi-Bit T50 5/16"	538574	—	TX50	FBS II 10 SK	1

1) Suitable for FMB TX Maxx Bit

2) Suitable for FPB Profi-Bit T50 5/16"



## Technical data



Vacuum cleaner FVC 35 M

Item	Art.-No.	Voltage [V]	Max. power from suction cup to socket [Watt]	Max. power [Watt]	Max. volume flow [l/s]	Negative pressure [mbar]	Noise pressure [dB (A)]	Contents	Weight [kg]	Dimensions [cm]
FVC 35 M	551924	220-240	2000 (220 - 240V~)	1400	73*	270*	69	1x Vacuum cleaner FVC 35 M, 1x Suction hose FVC SH, 2x Folded filter cartridges FVC FC, 1x Bag FVC PB	15,5	53 x 40 x 56 (Power cable length: 800)

\* Measured at motor head

## Accessories



Cleaning set FVC AP

Item	Item No.	Adapted for	Material	Contents	Sales unit [pcs]
FVC AP	552058	FVC 35 M	Plastic	1 x Hand tube with supplementary air slide, 30 cm long, Ø 35 mm 2 x Suction tube, 50 cm long, Ø 35 mm 1 x Floor nozzle, 30 cm broad, Ø 35 mm 1 x Crevice nozzle, 22 cm long, Ø 35 mm	1

## Accessories



Filter bag FVC FB



Bag FVC PB



Folded filter cartridges  
FVC FC



Suction hose FVC SH



Push handle FVC PH

Item	Item No.	Adapted for	Material	Dimensions accessories	Contents	Sales unit [pcs]
FVC FB	552059	FVC 35 M	Fleece	For 35 litre plastic container		1
FVC PB	552060	FVC 35 M	Polyethylene	For 35 litre plastic container		1
FVC FC	552061	FVC 35 M	Polyester	Filter surface 8600 cm <sup>2</sup>		1
FVC SH	552062	FVC 35 M	Polyethylene	Ø 35 mm, length 5 m		1
FVC PH	552063	FVC 35 M	Stainless steel	—		1

## Accessories



Hollow drill bit FHD



Detail:  
Top of drill FHD  
Ø 12 - 14 mm



Detail:  
Top of drill FHD  
Ø 16 - 18 mm  
Top of drill FHD Max  
Ø 16 - 35 mm

Item	Item No.	Contents	Sales unit [pcs]
FHD 12/200/330	546597	1	1
FHD 14/250/380	546598	1	1
FHD 16/250/380	546599	1	1
FHD 18/320/450	546600	1	1
FHD Max 16/400/620	546601	1	1
FHD Max 18/400/620	546602	1	1
FHD Max 20/400/620	546603	1	1
FHD Max 24/400/620	546604	1	1
FHD Max 28/600/820	546605	1	1
FHD Max 30/600/820	546606	1	1
FHD Max 35/650/870	546607	1	1

## Technical data



Gas actuated fastening tool  
FGC 100



Battery charger  
FGC 100 - BC



Li-Ion battery  
FGC 100-B 7.2 V - 2.5 Ah



XL-BOXX

Item	Item No.	Contents	Technical details	Sales unit [pcs]
Set FGC 100 (EU)	553411	1x fischer gas actuated fastening tool FGC 100, 1x Magazine FGC 100 – M26, 1x Battery charger FGC 100 – BC, 2x Li-Ion battery FGC 100-B 7.2 V – 2.5 Ah, 1x Push bar, 2x Hex wrench, 1x XL-BOXX	100 joules setting energy, 4.1 kg with battery, Capacity of 26 nails, curved, Input 100 – 240 V, Output 8.4 V – 2 A, > 8,000 fixings per charge, For the clearance of jammed nails, - Is fully compatible with the L-BOXX	1
Set FGC 100 (UK)	553585	1x fischer gas actuated fastening tool FGC 100, 1x Magazine FGC 100 – M26, 1x Battery charger FGC 100 – BC, 2x Li-Ion battery FGC 100-B 7.2 V – 2.5 Ah, 1x Push bar, 2x Hex wrench, 1x XL-BOXX	100 joules setting energy, 4.1 kg with battery, Capacity of 26 nails, curved, Input 100 – 240 V, Output 8.4 V – 2 A, > 8,000 fixings per charge, For the clearance of jammed nails, - Is fully compatible with the L-BOXX	1
Set FGC 100 (US)	553586	1x fischer gas actuated fastening tool FGC 100, 1x Magazine FGC 100 – M26, 1x Battery charger FGC 100 – BC, 2x Li-Ion battery FGC 100-B 7.2 V – 2.5 Ah, 1x Push bar, 2x Hex wrench, 1x XL-BOXX	100 joules setting energy, 4.1 kg with battery, Capacity of 26 nails, curved, Input 100 – 240 V, Output 8.4 V – 2 A, > 8,000 fixings per charge, For the clearance of jammed nails, - Is fully compatible with the L-BOXX	1
Set FGC 100 (AUS)	553587	1x fischer gas actuated fastening tool FGC 100, 1x Magazine FGC 100 – M26, 1x Battery charger FGC 100 – BC, 2x Li-Ion battery FGC 100-B 7.2 V – 2.5 Ah, 1x Push bar, 2x Hex wrench, 1x XL-BOXX	100 joules setting energy, 4.1 kg with battery, Capacity of 26 nails, curved, Input 100 – 240 V, Output 8.4 V – 2 A, > 8,000 fixings per charge, For the clearance of jammed nails, - Is fully compatible with the L-BOXX	1

5

## Accessories



Magazine standard  
FGC 100-M26



Magazine extended  
FGC 100-M50



Battery charger  
FGC 100 - BC



Li-Ion battery  
FGC 100-B 7.2 V - 2.5 Ah

Item	Item No.	Technical details	Sales unit [pcs]
Magazine standard FGC 100-M26	553412	Capacity of 26 nails, curved	1
Magazine extended FGC 100-M50	553717	Capacity of 50 nails, curved	1
Battery charger FGC 100-BC (EU)	553414	Input 100-240 V, Output 8.4 V – 2 A	1
Battery charger FGC 100-BC (UK)	553588	Input 100-240 V, Output 8.4 V – 2 A	1
Battery charger FGC 100-BC (US)	553589	Input 100-240 V, Output 8.4 V – 2 A	1
Battery charger FGC 100-BC (AUS)	553590	Input 100-240 V, Output 8.4 V – 2 A	1
Li-Ion battery FGC 100-B 7.2V 2.5Ah	553415	> 8,000 fixings per charge	1
FGC 100 Cleaning kit	553718	150 ml Cleaner, 100 ml Lubricating Oil and tool rubber sealing rings	1



## Accessories

Fuel cell  
FC 165Standard nail  
DFNHigh performance nail  
DFNHEWI plug  
TFDEWI nose  
FGC 100 - N EWIMagnetic nose piece supple-  
ment FGC 100 - N magnetic

Item	Item No.	Length L [mm]	Technical details	Contents
Fuel cell FC 165	553416	165	For more than 1,100 fixings	–
Standard nail DFN 17	553417	17	Gvz with 4 µm coating thickness, for soft concrete < C30/37, shaft diameter 2.6 mm, nail length 17 mm	1,008 nails + 1 fuel cell
Standard nail DFN 20	553418	20	Gvz with 4 µm coating thickness, for soft concrete < C30/37, shaft diameter 2.6 mm, nail length 20 mm	1,008 nails + 1 fuel cell
Standard nail DFN 22	553419	22	Gvz with 4 µm coating thickness, for soft concrete < C30/37, shaft diameter 2.6 mm, nail length 22 mm	1,008 nails + 1 fuel cell
Standard nail DFN 25	553420	25	Gvz with 4 µm coating thickness, for soft concrete < C30/37, shaft diameter 2.6 mm, nail length 25 mm	1,008 nails + 1 fuel cell
Standard nail DFN 30	553421	30	Gvz with 4 µm coating thickness, for soft concrete < C30/37, shaft diameter 2.6 mm, nail length 30 mm	1,008 nails + 1 fuel cell
Standard nail DFN 32	553422	32	Gvz with 4 µm coating thickness, for soft concrete < C30/37, shaft diameter 2.6 mm, nail length 32 mm	1,008 nails + 1 fuel cell
Standard nail DFN 35	553423	35	Gvz with 4 µm coating thickness, for soft concrete < C30/37, shaft diameter 2.6 mm, nail length 35 mm	1,008 nails + 1 fuel cell
Standard nail DFN 40	553424	40	Gvz with 4 µm coating thickness, for soft concrete < C30/37, shaft diameter 2.6 mm, nail length 40 mm	1,008 nails + 1 fuel cell
High performance nail DFNH 15	553425	15	Gvz with 4 µm coating thickness, for hard concrete ≥ C30/37 and steel, shaft diameter 3.0 mm, nail length 15 mm	1,008 nails + 1 fuel cell
High performance nail DFNH 17	553426	17	Gvz with 4 µm coating thickness, for hard concrete ≥ C30/37 and steel, shaft diameter 3.0 mm, nail length 17 mm	1,008 nails + 1 fuel cell
High performance nail DFNH 22	553427	22	Gvz with 4 µm coating thickness, for hard concrete ≥ C30/37 and steel, shaft diameter 3.0 mm, nail length 22 mm	1,008 nails + 1 fuel cell
High performance nail DFNH 27	553428	27	Gvz with 4 µm coating thickness, for hard concrete ≥ C30/37 and steel, shaft diameter 3.0 mm, nail length 27 mm	1,008 nails + 1 fuel cell
High performance nail DFNH 32	553429	32	Gvz with 4 µm coating thickness, for hard concrete ≥ C30/37 and steel, shaft diameter 3.0 mm, nail length 32 mm	1,008 nails + 1 fuel cell
FGC 100-N EWI	554869	–	For the use of fischer EWI plugs TFD 30 and TFD 50	1
FGC 100-N magnetic	553715	–	For the use with metal washers	2







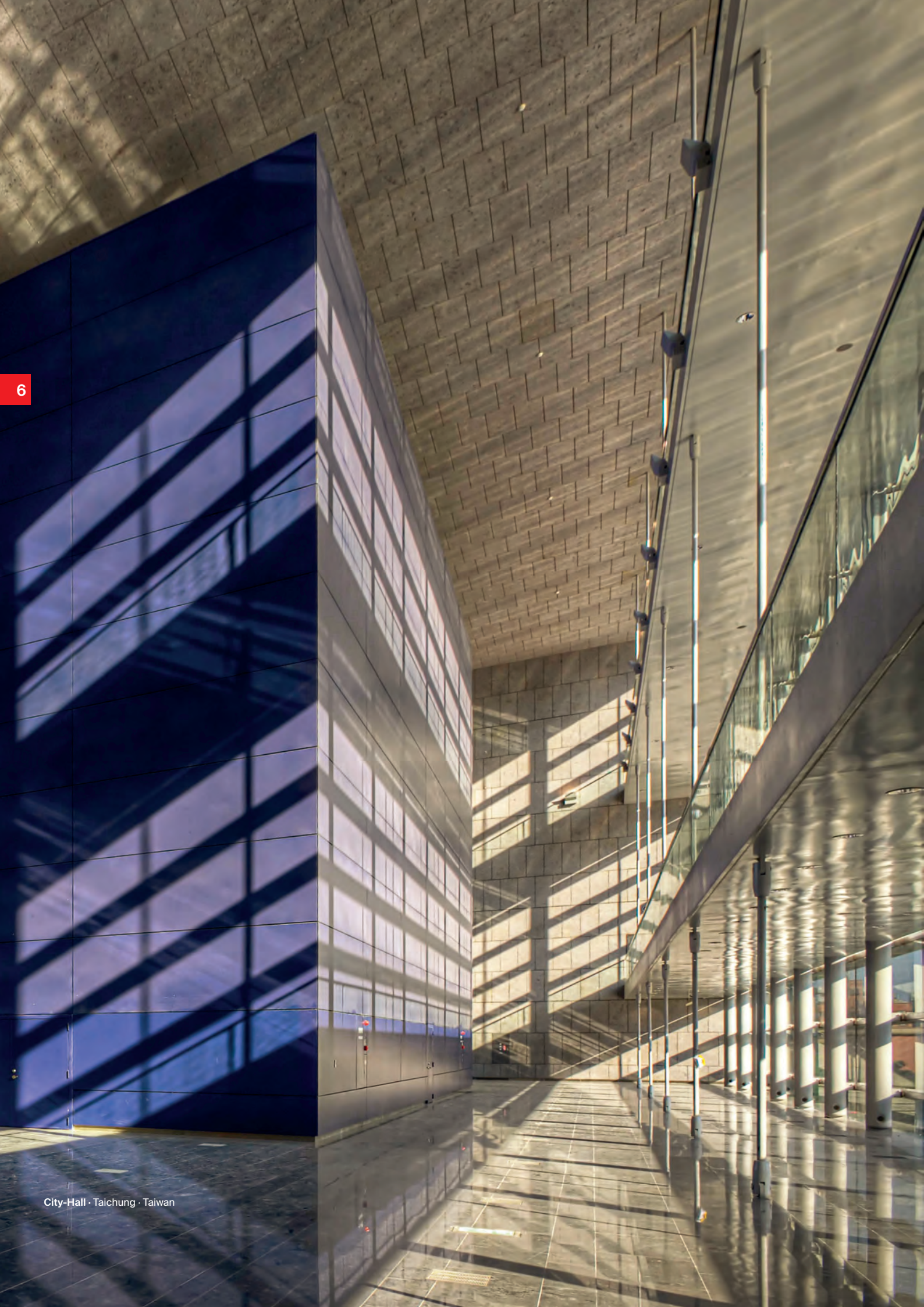



# 6

## Basics – good to know.

---

Basic knowledge undercut anchors	104
Basic knowledge subframe systems	107

---

Basic knowledge undercut anchors

# The secret of the concealed fixing solution.

The fischer façade system opens up the way for the design of advanced, complex façades - and all this in an easy and economic way. The reason lies in the system itself - FZP II, the fischer zykon panel anchor, which is an undercut anchor and therefore stress-free fixing

system that is installed into pre-drilled undercut holes. Internal reaction forces between anchor and material result not before the impact of external forces.

6



Undercut hole and behaviour of the Zykon panel anchor FZP II with and without external force

The undercut anchors are installed on the back of the panel, not visible from the front side of the façade and cause a clean joint pattern. This also requires the possibility of optimized positioning of the anchor. As a result, the bending strength in the panel is reduced by approximately 50% compared to common systems. Compared to common fixings, this technology provides a multiple load capacity, allows lower panel thicknesses and larger panel formats due to lower panel bending moments.

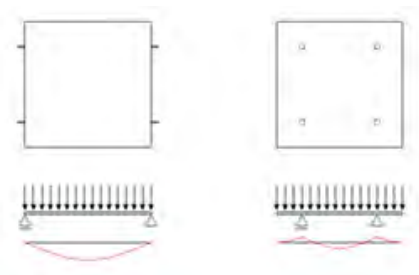

Optimization of the bending moment of the façade panel; left diagram shows clamp or pin fixing, right diagram shows undercut fixing

Materials such as natural stone, ceramics, artificial stone, HPL, fibre cement, solid surface panels and also glass (ESG = toughened safety glass and VSG = laminated safety glass) can be fixed with the fischer FZP II undercut anchors in combination with the fischer subframe systems, providing architects with a wide range of scope of design.

The perfectly matching fischer façade systems with the undercut anchors, fitting subframe and advanced drilling technology pays off on the construction site: Installation is simple, fast and independent of the weather. The construction time is shortened - and therefore the costs are also reduced.

# Earthquake-proof façade systems.

The FZP II also proves its worth in situations with the highest demands on the fixing system. Earthquake tests in Shanghai, China, impressively confirmed the outstanding performance of the undercut anchor. The various façade materials mounted with the FZP II withstood accelerations of up to 9.5 m/s<sup>2</sup>. This

corresponds to forces that cause considerable damage and destruction even in modern buildings designed for earthquakes.

These results have been confirmed by repeated tests in Italy and France.

6

## Various anchor types and installation methods.

There are two different installation methods for the fischer Zykon panel anchor FZP II:

### Flush installation

For flush installation, the installed anchor is flush with the back of the panel. The back of the panel is used as a reference for the constant drill hole depth.

### Stand-off installation

Thanks to the stand-off installation, the panel thickness tolerances that occur with natural stone panels can be compensated. With this type of installation the constant distance between the bottom of the drill hole and the front side of the panel, the remaining wall thickness (RWD), are used as the reference dimension. As a result, the drill hole depth becomes variable. Thanks to the use of the stand-off anchors the panel thickness tolerances can thus be compensated. This type of fixing is used, for example, for façade panels with panel thickness tolerances.



Flush installation of a fischer Zykon panel anchor FZP II.

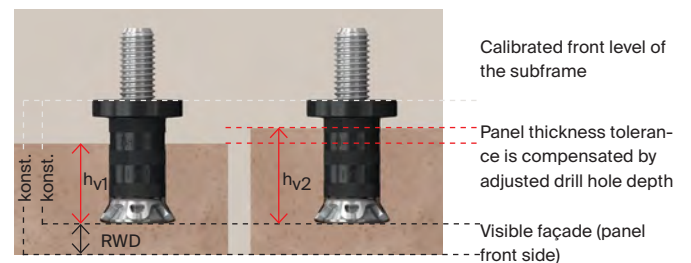

Stand-off installation of a fischer Zykon panel anchor FZP II SO.





Basic knowledge subframe systems

# Connection of the external wall and cladding.

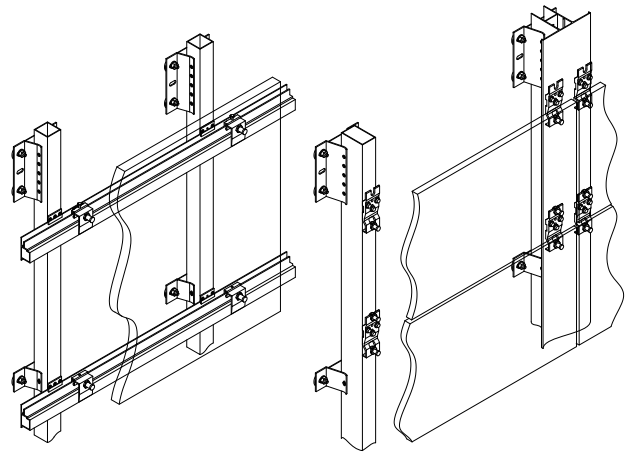

The subframe is the structural link between the external wall and the cladding. It allows the compensation of the shell tolerances. Wall holders and vertical profiles are responsible for the adjustable part of the façade structure. The constant part of the façade construction is determined by the thickness of the façade material and the constant construction dimension of the selected subframe system. fischer offers various types of façade subframe systems.

The panel material, panel size and system loads play a decisive role in the selection of the subframe. Different façade cladding materials require different demands on a subframe, e.g. in terms of load-bearing capacity, design and installation.



Systematic wall construction fischer subframe system

6

Selection of the suitable subframe system depending on the facade material			
	Horizontal profiles with clasps Bracket Solution – BS	Horizontal profiles with clasps Bracket Solution Light – BSL	Suspension clasps construction Vertical Solution – VS
			
Natural stone	++	+	++
Ceramics	0	+	0
HPL	+	++	-
Fiber cement	+	++	-
Glass	+	+	+

### The advantages at a glance

- Quick assembly due to hook-in system
- No visible fixing even in the joints
- Designed for high loads
- Bridging of non-load-bearing building fabric
- Ideally suited for skeleton constructions
- Mechanical fixing of reveal panels
- Non-destructive replacement of façade panels







# 7 Service

---

Portfolio	110
Subsidiaries	116
Article index sorted by product name	118
Article index sorted by article number	120

---

# Technical manual FireStop.

Products for use in passive fire protection.

The FireStop catalogue offers many facts and assists with fast and safe product selection, e.g:

- Basics of passive fire protection
- Product and system presentations
- Application guides
- Detailed technical data and drawings
- In short: Everything you need to know about the use of fischer passive fire protection systems

7

Don't wait. Ask for the technical manual FireStop under the hotline +49 (0) 180 5 202901 or by fax +49 (0) 7443 12 - 4500.



## Professional App

# The mobile fixing consultant for the craftsman.



### Online Catalogue

Inform yourself about all fischer products. You will also find relevant technical data and load values.



### News

Here you will find all information about fischer - like product innovations or company highlights.



### Product advisor

Find the right fixing solution directly to your application.

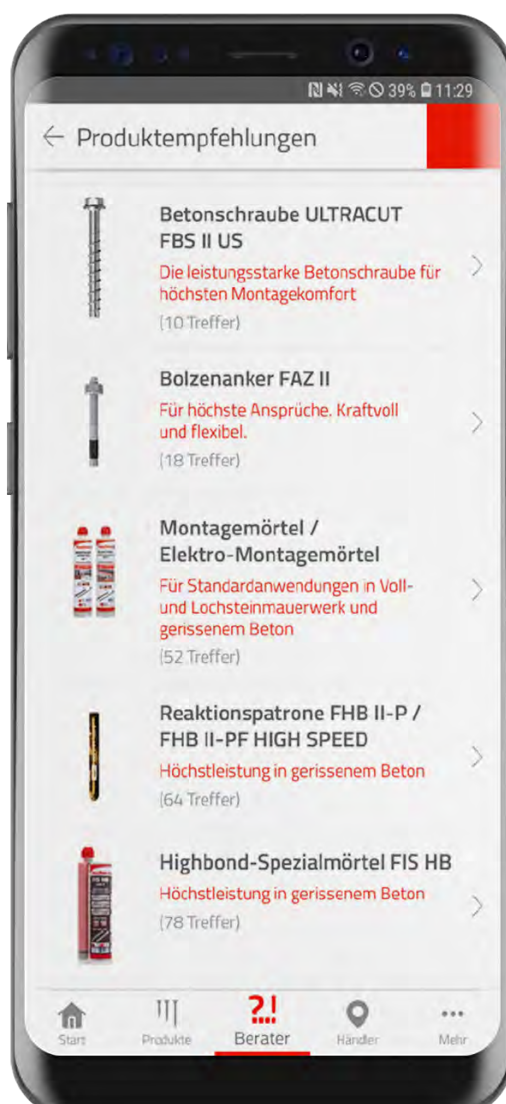

### Barcode scanner

Scan your product and you will receive all relevant information. For example, for installation.



### Live chat

Benefit in direct contact from the many years of practical experience of the fischer engineers and technicians.



### Dealer search

Find the dealer nearest you, which also offers your selected product in the assortment.



from now on in the Google Play & App Store

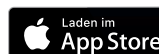



# Main catalogue Installation Systems.

Products for use in installation technology

All facts about the fischer installation systems.

- Product and system presentations
- Anchors suitable to fix installation system components
- Application support
- Detailed technical data and drawings
- Basics knowledge of installation systems
- In short: Everything you need to know about the fischer installation systems

7

Don't wait. Require the main catalogue Installation Systems at the Hotline +49 (0) 180 5 202901 or per fax to +49 (0) 7443 12 - 4500.



# Main catalogue Fixing Systems.

## Products for use in fixing technology

The fixing catalogue offers all facts and helps with quick and safe product selection, e.g.:

- Product descriptions with advantages/benefits at a glance
- Assembly tips
- Application support
- Detailed technical data and drawings
- Basics knowledge of fixing technology
- Everything you need to know about professional fixing

Don't wait. Require the main catalogue Fixing Systems at the Hotline +49 (0) 180 5 202901 or per fax to +49 (0) 7443 12-4500.



# Security is calculable FIXPERIENCE.



7

The fischer design software FIXPERIENCE supports you as planners, structural engineers and craftsmen safe and reliable in sizing your projects. FIXPERIENCE is modular and can be

used for a variety of applications. The new, modular structure of the program includes an engineering software and special application modules:



**C-FIX:**  
The anchor dimensioning program for steel and composite anchors in concrete.



**WOOD-FIX:**  
For the calculation of wood connections and reinforcements with fischer screws.



**INSTALL-FIX:**  
The design program for building services.



**REBAR-FIX:**  
For the design of subsequent reinforcement connections in reinforced concrete construction.



Download fischer FIXPERIENCE now for free:  
[www.fischer.de/fixperience](http://www.fischer.de/fixperience)



**FACADE-FIX:**  
To design the anchoring of Facade substructures made of wood.



**RAIL-FIX:**  
To design the anchoring of Stair and balcony railings.



**MORTAR-FIX:**  
To determine the injection mortar requirement for composite anchors in concrete.



**Electronic planning folder:**  
All important documents and records from fischer in one program.



# Main catalogue Screws.

## Products for use in timber construction

The screw catalogue offers many facts and helps with fast and safe product selection, for example:

- Description of assortment
- Load tables for construction screws
- Detailed technical data

Don't wait. Require the main catalogue Screws at the  
Hotline +49 (0) 180 5 202901 or  
per fax to +49 (0) 7443 12-4500.



## Germany

**fischer Deutschland Vertriebs GmbH**  
Klaus-Fischer-Straße 1  
72178 Waldachtal  
T +49 7443 12-6000  
F +49 7443 12-4500  
info@fischer.de  
www.fischer.de

## Argentina

**fischer Argentina s.a.**  
Armenia 3044  
1605 Munro Ra-PCIA Buenos Aires  
T +54 1147 62 27 78  
F +54 1147 56 13 11  
asistenciatecnica@fischer.com.ar  
www.fischer.com.ar

## Austria

**fischer Austria GmbH**  
Wiener Straße 95  
2514 Traiskirchen  
T +43 2252 53730 0  
F +43 2252 53730 70  
office@fischer.at  
www.fischer.at

## Belgium

**fischer Cobemabel snc**  
Schaliënhoeverdreef 20 D  
2800 Mechelen  
T +32 152 8 47 00  
F +32 152 8 47 10  
info@fischer.be  
www.fischer.be

## Brazil

**fischer brasil Industria e Comercio Ltda.**  
Estrada do Dende, 300 Ilha do Governador  
21920-001 Rio de Janeiro-RJ  
T +55 21 2467 11 30  
F +55 21 2467 01 44  
fischer@fischerbrasil.com.br  
www.fischerbrasil.com.br

## China

**fischer (Taicang) fixings Co. Ltd.**  
Shanghai Rep. Office Rm 1503-1504,  
No. 63 Chifeng Road, 200092 Shanghai  
T +86-021-65 97 53 88  
F +86-021-65 97 96 22  
ficnsh@fischer.com.cn  
www.fischer.com.cn

## China

**fischer (Taicang) fixings Co. Ltd.**  
Building 1, No.105 North Dongcang Rd.  
215400 Taicang Jiangsu  
T +86 512 53 58 89 38  
F +86 512 53 58 89 48  
ficn@fischer.com.cn  
www.fischer.com.cn

## Czech Republic

**fischer international s.r.o.**  
Průmyslová 1833  
25001 Brandýs nad Labem  
T +42 03 26 90 46 01  
F +42 03 26 90 46 00  
info@fischer-cz.cz  
www.fischer-cz.cz

## Denmark

**fischer a/s**  
Sandvadsvej 17 A  
4600 Køge  
T +45 46 32 02 20  
F +45 46 32 50 52  
fidk@fischerdanmark.dk  
www.fischerdanmark.dk

## Finland

**fischer Finland Oy**  
Suomalaistentie 7 B  
02270 Espoo  
T +358 20 741 46 60  
F +358 20 741 46 69  
orders@fischerfinland.fi  
www.fischerfinland.fi

## France

**fischer S. A. S.**  
12, rue Livio, P. O. Box 10182  
67022 Strasbourg-Cedex 1  
T +33 388 39 18 67  
F +33 388 39 80 44  
info@fischer.fr  
www.fischer.fr

## Greece

**fischer Hellas**  
Nat. Road Athens-Lamia (17th) &  
Roupeil 6, 14564 Kifissia Athens  
T +30 210 283 81 67  
F +30 210 283 81 69  
info@fischer.gr  
www.fischer.gr

## Hungary

**fischer Hungária Bt.**  
Szerémi út 7/b  
1117 Budapest  
T +36 1 347 97 55  
F +36 1 347 97 66  
info@fischerhungary.hu  
www.fischerhungary.hu

## India

**fischer BUILDING MATERIAL INDIA PVT LTD.**  
PRESTIGE GARNET UNIT NO- 401,  
4TH FLOOR 36, ULSOOR ROAD  
560042 Bangalore KARNATAKA  
T +91 08041511991 92 93  
F +91 08041511989  
info@fischer.in  
www.fischer.in

## Italy

**fischer italia S.R.L**  
Corso Stati Uniti, 25, Casella Postale 391  
35127 Padova Z.I. Sud  
T +39 049 8 06 31 11  
F +39 049 8 06 34 01  
sercli@fischeritalia.it  
www.fischeritalia.it

## Japan

**fischer Japan K.K.**  
Seishin Kudan Building 3rd Floor 3-4-15  
Kudan Minami Chiyoda-ku, 102-0074 Tokyo  
T +81 3 3263 44 91  
F +81 3 6272 99 35  
info@fischerjapan.co.jp  
www.fischerjapan.co.jp

## Korea, Republic

**fischer Korea Co., Ltd (fikir)**  
Room 601/602, Kolon Digital Billant 30,  
Digitalro 32-Gil, Guro-Gu, Seoul,  
Korea 08390  
T +82 1544 89 55  
F +82 1544 89 03  
info@fischerkorea.com  
www.fischerkorea.com

## Mexico

**fischer Sistemas de Fijación, S.A. de C.V.**  
Bld. Manuel Avila Camacho 3130-400B  
54020 Col. Valle Dorado, Tlalnepantla  
T +52 55 55 72 08 83  
F +52 55 55 72 15 90  
info@fischermex.com.mx  
www.fischermex.com.mx

**Netherlands**

**fischer Benelux B.V.**  
 Amsterdamsestraatweg 45 B/C  
 1411 AX Naarden  
 T +31 35 6 95 66 66  
 F +31 35 6 95 66 99  
 info@fischer.nl  
 www.fischer.nl

**Norway**

**fischer Norge AS**  
 Oluf Onsumsvei 9  
 0680 Oslo  
 T +47 23 24 27 10  
 F +47 23 24 27 13  
 ordre@fischernorge.no  
 www.fischernorge.no

**Philippines**

**fischer PH Asia, Inc.**  
 No 100 Congressional Avenue, Project 8  
 1106 Quezon City  
 T +63 2426 / 0888 217  
 F +63 28803256  
 joselito.ladlad@fischerph.com  
 www.fischer.ph

**Poland**

**fischerpolska Sp.z o.o**  
 ul. Albatrosow 2  
 30-716 Kraków  
 T +48 12 2 90 08 80  
 F +48 12 2 90 08 88  
 info@fischerpolska.pl  
 www.fischerpolska.pl

**Portugal**

**fischerwerke Portugal, Lda.**  
 Rua das Musas, Passeio dos Cruzados  
 Lote 2.01 (Bloco3), Loja 8 (01.D) / Parque  
 das Nações, 1990-171 Lisboa  
 T +351 218 954 180  
 F +351 218 967 066  
 fischerportugal.info@fischer.pt  
 www.fischer.pt

**Russian Federation**

**OOO fischer Befestigungssysteme Rus**  
 Leningradskoe shosse, 47, Bldg. 2, 2nd  
 floor, apt. VI, 125195 Moscow  
 T +7 495 223 61 62  
 F +7 495 223 03 34  
 info@fischerfixings.ru  
 www.fischerfixings.ru

**Romania**

**fischer fixings Romania S.R.L.**  
 Strada Oradiei, Nr. 1-3-5-7  
 400220 Cluj  
 T +40 264 455 166  
 F +40 264 403060  
 zoltan.kovacs@fischer.com.ro  
 www.fischer.com.ro

**Singapore**

**fischer systems Asia Pte. Ltd.**  
 4 Kaki Bukit Avenue 1, #01-06  
 417939 Singapore  
 T +65 62 85 22 07  
 F +65 62 85 83 10  
 sales@fischer.sg  
 www.fischer.sg

**Slovakia**

**fischer S.K. s.r.o.**  
 Nová Rožňavská 134 A  
 831 04 Bratislava  
 T +421 2 4920 60 46  
 F +421 2 4920 60 44  
 info@fischerwerke.sk  
 www.fischer-sk.sk

**Spain**

**fischer Ibérica S.A.U.**  
 Klaus Fischer 1  
 43300 Mont-Roig del Camp Tarragona  
 T +34 977 83 87 11  
 F +34 977 83 87 70  
 servicio.cliente@fischer.es  
 www.fischer.es

**Sweden**

**fischer Sverige AB**  
 Tenngatan 4  
 602 23 Norrköping  
 T +46 11 31 44 52  
 F +46 11 33 19 50  
 gg@fischersverige.se  
 www.fischersverige.se

**Turkey**

**fischer Metal Sanayi Ve Ticaret Ltd Sti**  
 Cevizli Mahallesi, Mustafa Kemal Paşa Cad.  
 Seyit Gazi Sok. No 66, Hukukçular Towers A  
 Blok, 34865 Kartal İstanbul  
 T +90 216 326 00 66  
 F +90 216 326 00 18  
 info@fischer.com.tr  
 www.fischer.com.tr

**United Arab Emirates**

**fischer FZE**  
 R/A 07, BA - 04, Jebel Ali Free Zone  
 Dubai  
 T +97 14 8 83 74 77  
 F +97 14 8 83 74 76  
 enquiry@fischer.ae  
 www.fischer.ae

**United Kingdom**

**fischer fixings UK Ltd.**  
 Whitely Road  
 Oxon OX10 9AT Wallingford  
 T +44 1491 82 79 00  
 F +44 1491 82 79 53  
 info@fischer.co.uk  
 www.fischer.co.uk

**United States**

**fischer fixings LLC (fius)**  
 205 US HWY 46, Suite 4 07512 Totowa,  
 New Jersey  
 T +1 973 256 30 45  
 F +1 845 625 26 66  
 sales@fischerus.net  
 www.fischerfixings.com



Abbreviation	Item No.	Page	Abbreviation	Item No.	Page	Abbreviation	Item No.	Page
Adjustable wedge VS	521675	85	FBS II 8x100 50/35 US TX	536855	88	FVC SH	552062	98
Battery charger FGC 100-BC (AUS)	553590	99	FBS II 8x80 30/15 US TX	536853	88	FZE 10 plus	044637	69
Battery charger FGC 100-BC (EU)	553414	99	FBS II 8x90 40/25 US TX	536854	88	FZE 12 plus	044638	69
Battery charger FGC 100-BC (UK)	553588	99	FGC 100 Cleaning kit	553718	99	FZE 14 plus	044639	69
Battery charger FGC 100-BC (US)	553589	99	FGC 100-N EW1	554869	100	FZP 13 x 30 M8//23 SH A4	521103	33
Blind rivet 4,8 x 12 A4	521664	82	FGC 100-N magnetic	553715	100	FZP 13 x 41 M8/SO/19 SH AL	521104	33
BR-BS M6/100	091536	75	FHB II-A S M10 x 60/10	097072	89	FZP 15 x 15,5 M8/16 G-Z	047300	47
BR-BS M6/50	048904	75	FHB II-A S M10 x 60/10 R	097630	89	FZP 15 x 15,5 M8/16 G-Z 6KT	051442	47
BR-BS M8/100	078585	75	FHB II-A S M10 x 60/10 HCR	097704	89	FZP 15 x 17,5 M8/14 G-Z	050407	47
BR-BS M8/150	078587	75	FHB II-A S M10 x 60/20	097073	89	FZP 15 x 17,5 M8/14 G-Z 6KT	051447	47
BR-BS M8/50	049238	75	FHB II-A S M10 x 60/20 R	097631	89	FZP 15 x 6 M8/11 G-Z	047254	45
BR-BSL 40-M6	018439	76	FHB II-A S M10 x 60/20 HCR	097705	89	FZP 15 x 6 M8/11 G-Z 6KT	051435	45
BR-BSL 40-M8	018448	76	FHB II-P 10 x 60	096847	89	FZP 15 x 6 M8/25 G-Z	047259	45
BR-BSL 90-M8	018447	76	FHB II-PF 10 x 60	500547	89	FZP 15 x 6 M8/25 G-Z 6KT	051436	45
BR-VS 50-F	521662	76	FHD 12/200/330	546597	98	FZP 15 x 7 M8/10 G-Z	047273	45
BR-VS 50-S	521663	76	FHD 14/250/380	546598	98	FZP 15 x 7 M8/10 G-Z 6KT	051440	45
BSN 100 VD	046223	53	FHD 16/250/380	546599	98	FZP 15 x 7 M8/24 G-Z	047274	45
BSN 100 VP	061502	53	FHD 18/320/450	546600	98	FZP 15 x 7 M8/24 G-Z 6KT	051441	45
BSN 101T	802484	57	FHD Max 16/400/620	546601	98	FZP II 11 x 10 M6/T/9 PA	520369	41
BST 502	046235	58	FHD Max 18/400/620	546602	98	FZP II 11 x 12 M6/13 A4	512131	23
BST 80	046228	58	FHD Max 20/400/620	546603	98	FZP II 11 x 12 M6/13 CARBON	511966	25
Centring sleeve PBZ	090671	92	FHD Max 24/400/620	546604	98	FZP II 11 x 12 M6/18 A4	512133	23
CNC adapter	804063	62	FHD Max 28/600/820	546605	98	FZP II 11 x 12 M6/18 CARBON	511967	25
Cold Bridge Stopp CBS	092680	82	FHD Max 30/600/820	546606	98	FZP II 11 x 15 M6/10 A4	512134	23
Cone drill PBB	090634	92	FHD Max 35/650/870	546607	98	FZP II 11 x 15 M6/10 CARBON	511968	25
Cover plate HP-Clip	096451	82	FIS A M 10 x 110	090278	90	FZP II 11 x 15 M6/18 A4	512135	23
DHK 100	080940	94	FIS A M 10 x 110	090278	91	FZP II 11 x 15 M6/18 CARBON	511969	25
DHK 120	080941	94	FIS A M 10 x 110	090278	91	FZP II 11 x 21 M6/SO/12 AL	512145	27
DHK 140	080949	94	FIS A M 10 x 110	090278	91	FZP II 11 x 21 M6/SO/12 CARBON	511978	29
DHK 160	512150	94	FIS A M 10 x 110	090278	90	FZP II 11 x 21 M6/SO/9 AL	512144	27
DHK 180	512151	94	FIS A M 10 x 110 R	090444	91	FZP II 11 x 21 M6/SO/9 CARBON	511977	29
DHK 200	512153	94	FIS A M 10 x 110 R	090444	91	FZP II 11 x 21 M6/V5/4 AL	512147	31
DHK 220	512154	94	FIS A M 10 x 110 R	090444	90	FZP II 11 x 6 M6/T/10 PA	520365	41
DHK 80	080939	94	FIS A M 10 x 110 R	090444	91	FZP II 11 x 6 M6/T/9 D40 PA	532644	43
DHM 135	503131	94	FIS A M 10 x 110 R	090444	90	FZP II 11 x 8 M6/T/10 D40 PA	532645	43
DHM 150	061582	94	FIS H 16 x 85 K	041902	92	FZP II 11 x 8 M6/T/12 PA	520367	41
DHM 200	519317	94	FIS HB 345 S	033211	89	FZP II 11 x 9 M6/T/9 D40 PA	532646	43
DHM 250	519318	94	FIS MR Plus	545853	90	FZP II 13 x 12 M6i	512958	37
DHM 90	088803	94	FIS MR Plus	545853	89	FZP II 13 x 15 M8/10 A4	512136	23
DMS 0,5 - 13,5 Nm	102863	66	FIS V 360 S	043994	90	FZP II 13 x 15 M8/10 CARBON	511970	25
DPL 11	802339	66	FIS V 360 S	068435	90	FZP II 13 x 15 M8/15 A4	512137	23
DPL 11T	804089	66	FIS V 360 S	094404	90	FZP II 13 x 15 M8/15 CARBON	511971	25
DPL 13	802338	66	FIS V 360 S	094405	90	FZP II 13 x 15 M8/23 A4	512138	23
DPL 15	804184	66	FIS V 360 S	502283	90	FZP II 13 x 15 M8/23 CARBON	511972	25
DT 60/10	044317	95	Fixit	048905	81	FZP II 13 x 15 M8/28 A4	512139	23
DT 90/4	080957	95	FMB T30 Maxx Bit W 5	533158	96	FZP II 13 x 15 M8/28 CARBON	511973	25
DT 90/8	080958	95	FMB T40 Maxx Bit W 5	533159	96	FZP II 13 x 17 M8/17 A4	512140	23
DTM 60/10 A4	088805	95	FPB Profi-Bit T50 5/16"	538574	96	FZP II 13 x 17 M8/17 CARBON	511980	25
DTM 70/10 zinc	044318	95	FPH 133	030367	79	FZP II 13 x 21 M8/17 A4	512142	23
ESR 13,5 - 15,5	802543	66	FPH 30	018442	79	FZP II 13 x 21 M8/17 CARBON	511975	25
ES-BS	521673	85	FPH 54	018444	79	FZP II 13 x 21 M8/22 A4	512143	23
ES-BSL	521672	85	FPH 68	048900	79	FZP II 13 x 21 M8/22 CARBON	511976	25
FABSA 23 5,5 x 38 A2 DS16	092379	83	FPH 93	048901	79	FZP II 13 x 21 M8/9 A4	512141	23
FADI A 6,5 x 32 A4 DS16	092123	83	FUP 10	537201	96	FZP II 13 x 21 M8/9 CARBON	511974	25
FAZ II 10/10	094981	88	FUP 12	537202	96	FZP II 13 x 26 M8/SO/12 AL	538088	27
FAZ II 10/10 R	501403	88	FUP 14	537203	96	FZP II 13 x 26 M8/SO/12 CARBON	538087	29
FAZ II 10/20	094982	88	FUP 8	537200	96	FZP II 13 x 26 M8/SO/17 AL	512146	27
FAZ II 10/20 R	501406	88	Fuel cell FC 165	553416	100	FZP II 13 x 26 M8/SO/17 CARBON	511979	29
FAZ II 8/10	094871	88	FVC AP	552058	97	FZP II 13 x 26 M8/VS/4 AL	512148	31
FAZ II 8/10 R	501396	88	FVC FB	552059	98	FZP II 13 x 30 M8/SO/13 AL	513226	27
FBS II 10x100 45/35/15 US	536862	88	FVC FC	552061	98	FZP II 13 x 30 M8/VS/4 AL	512149	31
FBS II 10x70 15/5/- US	536859	88	FVC PB	552060	98	FZP II 15 x 12 M8i	539478	35
FBS II 10x80 25/15/- US	536860	88	FVC PH	552063	98	FZP II 15 x 15 M8i	539479	35

Abbreviation	Item No.	Page	Abbreviation	Item No.	Page	Abbreviation	Item No.	Page
FZP II 15 x 21 M8i	540298	35	Socket wrench SW10	802168	85	VP 30/2	077545	77
FZPB 11	060710	61	Socket wrench SW13	802169	85	VP 40/2	077546	77
FZPB 11T CNC	522398	62	SPH 133	030368	79	VP 50/2	048895	77
FZPB 11T CNC-DIA	541464	62	SPH 30	018443	79	VP 80/2	048896	77
FZPB 11T D12	522402	61	SPH 54	018445	79	Washer M6-A4	523231	83
FZPB 11/21 CNC	535984	62	SPH 68	048902	79	Washer M8-A4	523232	83
FZPB 11/28	092880	61	SPH 93	048903	79			
FZPB 11/28 CNC	530911	62	Spike washer M6 - A4	049914	83			
FZPB 13	060711	61	Spike washer M8 - A4	049915	83			
FZPB 13 G6	019265	63	STU 10 - 30	802506	65			
FZPB 13 G7	019266	63	Standard nail DFN 17	553417	100			
FZPB 13/21 CNC	535985	62	Standard nail DFN 20	553418	100			
FZPB 13/38 CNC	540698	62	Standard nail DFN 22	553419	100			
FZPB 15	530908	61	Standard nail DFN 25	553420	100			
FZPB 15/28 CNC	547077	62	Standard nail DFN 30	553421	100			
FZPB 9	060713	61	Standard nail DFN 32	553422	100			
FZPB 9T	530910	61	Standard nail DFN 35	553423	100			
High performance nail DFNH 15	553425	100	Standard nail DFN 40	553424	100			
High performance nail DFNH 17	553426	100	Strip holder bracket solution	079169	82			
High performance nail DFNH 22	553427	100	SW10	538577	96			
High performance nail DFNH 27	553428	100	SW13	538578	96			
High performance nail DFNH 32	553429	100	SW15	538579	96			
HK 36 plastic	004283	95	SW17	538580	96			
HP-BS	048899	74	SW21	538581	96			
HP-BSL	018438	74	SXR 10 x 100 FUS	046331	93			
HV 36 zinc	004286	95	SXR 10 x 100 FUS A4	046342	93			
HVL 11	802333	65	SXR 10 x 120 FUS	046332	93			
HVL 11T	802732	65	SXR 10 x 120 FUS A4	046343	93			
HVL 13	802337	65	SXR 10 x 140 FUS	046333	93			
HVL 15	804186	65	SXR 10 x 140 FUS A4	046344	93			
ISO-disk 8/60	001680	95	SXR 10 x 160 FUS	046334	93			
LBT 80	046225	55	SXR 10 x 160 FUS A4	046345	93			
Li-Ion battery FGC 100-B 7.2V 2.5Ah	553415	99	SXR 10 x 60 FUS	046329	93			
Lock nut M6 A4	521669	84	SXR 10 x 60 FUS A4	046339	93			
Lock nut M8 A4	521670	84	SXR 10 x 80 FUS	046330	93			
LW 50-M6	078995	81	SXR 10 x 80 FUS A4	046340	93			
LW 50-M8	079148	81	SXRL 10 x 100 FUS	522720	93			
Magazine extended FGC 100-M50	553717	99	SXRL 10 x 100 FUS A4	522731	93			
Magazine standard FGC 100-M26	553412	99	SXRL 10 x 120 FUS	522721	93			
MB 2	061130	56	SXRL 10 x 120 FUS A4	522732	93			
MST	802575	65	SXRL 10 x 140 FUS	522723	93			
MST-D	802507	65	SXRL 10 x 140 FUS A4	522733	93			
NSG (price)	046236	85	SXRL 10 x 160 FUS	522724	93			
Nut M6 A4	521667	84	SXRL 10 x 160 FUS A4	522734	93			
Nut M8 A4	521668	84	SXRL 10 x 80 FUS	522719	93			
Profile guidance GLB	048906	81	SXRL 10 x 80 FUS A4	522730	93			
PSV-BS	521665	84	T 60	077692	78			
PSV-BSL	018446	84	T110	509279	78			
PSV-VS	049905	84	Tergo+ 11 x 10 M6/T/9 PA	532643	39			
SBN 502	061500	54	Tergo+ 11 x 6 M6/T/10 PA	532641	39			
Screw locking liquid 10ml	521676	84	Tergo+ 11 x 6 M6/T/13 PA	532642	39			
Serrated Nut M6 A4	541613	84	Tergo+ 11 x 8 M6/T/10 PA	537974	39			
Serrated Nut M8 A4	541614	84	Tergo+ 11 x 8 M6/T/13 PA	537975	39			
Set FGC 100 (AUS)	553587	99	TX40	538575	96			
Set FGC 100 (EU)	553411	99	TX50	538576	96			
Set FGC 100 (UK)	553585	99	Vacuum cleaner SSG	802596	59			
Set FGC 100 (US)	553586	99	Vacuum pump VP	802597	59			
SGA-M6	803749	69	Venturi nozzle VD	802111	59			
SGA-M8	803748	69	VP 100/2	048897	77			
SGA-M8i	804432	69	VP 120/3	048898	77			
SGB/110V	804097	69	VP 150/3	097884	77			
SGB/230V	802522	69	VP 180/3	097885	77			
SGT	802669	69	VP 25/2	018441	77			

Article index according to article number

Item No.	Page	Item No.	Page	Item No.	Page	Item No.	Page	Item No.	Page	Item No.	Page
001680	95	050407	47	102863	66	521673	85	546599	98	804089	66
004283	95	051435	45	500547	89	521675	85	546600	98	804097	69
004286	95	051436	45	501396	88	521676	84	546601	98	804184	66
018438	74	051440	45	501403	88	522398	62	546602	98	804186	65
018439	76	051441	45	501406	88	522402	61	546603	98	804432	69
018441	77	051442	47	502283	90	522719	93	546604	98		
018442	79	051447	47	503131	94	522720	93	546605	98		
018443	79	060710	61	509279	78	522721	93	546606	98		
018444	79	060711	61	511966	25	522723	93	546607	98		
018445	79	060713	61	511967	25	522724	93	547077	62		
018446	84	061130	56	511968	25	522730	93	552058	97		
018447	76	061500	54	511969	25	522731	93	552059	98		
018448	76	061502	53	511970	25	522732	93	552060	98		
019265	63	061582	94	511971	25	522733	93	552061	98		
019266	63	068435	90	511972	25	522734	93	552062	98		
030367	79	077545	77	511973	25	523231	83	552063	98		
030368	79	077546	77	511974	25	523232	83	553411	99		
033211	89	077692	78	511975	25	530908	61	553412	99		
041902	92	078585	75	511976	25	530910	61	553414	99		
043994	90	078587	75	511977	29	530911	62	553415	99		
044317	95	078995	81	511978	29	532641	39	553416	100		
044318	95	079148	81	511979	29	532642	39	553417	100		
044637	69	079169	82	511980	25	532643	39	553418	100		
044638	69	080939	94	512131	23	532644	43	553419	100		
044639	69	080940	94	512133	23	532645	43	553420	100		
046223	53	080941	94	512134	23	532646	43	553421	100		
046225	55	080949	94	512135	23	533158	96	553422	100		
046228	58	080957	95	512136	23	533159	96	553423	100		
046235	58	080958	95	512137	23	535984	62	553424	100		
046236	85	088803	94	512138	23	535985	62	553425	100		
046329	93	088805	95	512139	23	536853	88	553426	100		
046330	93	090278	91	512140	23	536854	88	553427	100		
046331	93	090278	91	512141	23	536855	88	553428	100		
046332	93	090278	90	512142	23	536859	88	553429	100		
046333	93	090278	91	512143	23	536860	88	553585	99		
046334	93	090278	90	512144	27	536862	88	553586	99		
046339	93	090444	91	512145	27	537200	96	553587	99		
046340	93	090444	91	512146	27	537201	96	553588	99		
046342	93	090444	91	512147	31	537202	96	553589	99		
046343	93	090444	90	512148	31	537203	96	553590	99		
046344	93	090444	90	512149	31	537974	39	553715	100		
046345	93	090634	92	512150	94	537975	39	553717	99		
047254	45	090671	92	512151	94	538087	29	553718	99		
047259	45	091536	75	512153	94	538088	27	554869	100		
047273	45	092123	83	512154	94	538574	96	802111	59		
047274	45	092379	83	512958	37	538575	96	802168	85		
047300	47	092680	82	513226	27	538576	96	802169	85		
048895	77	092880	61	519317	94	538577	96	802333	65		
048896	77	094404	90	519318	94	538578	96	802337	65		
048897	77	094405	90	520365	41	538579	96	802338	66		
048898	77	094871	88	520367	41	538580	96	802339	66		
048899	74	094981	88	520369	41	538581	96	802484	57		
048900	79	094982	88	521103	33	539478	35	802506	65		
048901	79	096451	82	521104	33	539479	35	802507	65		
048902	79	096847	89	521662	76	540298	35	802543	66		
048903	79	097072	89	521663	76	540698	62	802575	65		
048904	75	097073	89	521664	82	541464	62	802596	59		
048905	81	097630	89	521665	84	541613	84	802597	59		
048906	81	097631	89	521667	84	541614	84	802669	69		
049238	75	097704	89	521668	84	545853	89	802732	65		
049905	84	097705	89	521669	84	545853	90	803748	69		
049914	83	097884	77	521670	84	546597	98	803749	69		
049915	83	097885	77	521672	85	546598	98	804063	62		





[www.fischer-international.com](http://www.fischer-international.com)



fischer stands for

Fixing Systems  
Automotive  
fischertechnik  
Consulting  
LNT Automation

---

fischerwerke GmbH & Co. KG  
Klaus-Fischer-Straße 1 · 72178 Waldachtal  
Germany  
T +49 7443 12-0  
[www.fischer-international.com](http://www.fischer-international.com) · [facades@fischer.de](mailto:facades@fischer.de)

---

